

CATÁLOGO | 2022



LOUIS TELLIER

RIEN NE REMPLACE LE FAIT MAIN



www.louistellier.fr



**LOUIS TELLIER**

RIEN NE REMPLACE LE FAIT MAIN

1887

Esta historia comienza dos años antes de la construcción de la Torre Eiffel. París se está convirtiendo en el centro de la creación mundial. La gastronomía francesa se desarrolla y despierta la curiosidad de los gourmets y chefs de todo el mundo.

Los postres, cada vez más sofisticados, se convierten en los símbolos ineludibles del gourmet para grandes ocasiones. Un empresario visionario, ETIENNE GOBEL, apuesta por el hecho de que este entusiasmo por la pastelería no ha hecho más que empezar y se lanza a la fabricación de moldes para pasteles, de cobre y hojalata. El éxito es inmediato e internacional. Pronto su espacio parisino se quedó pequeño e instala su fábrica en Turena, donde sigue en la actualidad y donde continúa la tradición.

1947

Sesenta años después, Francia está en plena reconstrucción. Las verduras vuelven a los platos de los habitantes y en especial la patata. Establecida como una de las joyas de la gastronomía francesa en el siglo XIX, los restauradores esperaban su regreso.

Uno de ellos pidió a un amigo mecánico que imaginara un aparato para facilitar la preparación del puré. LOUIS TELLIER acepta el reto e inventa el primer molinillo de verduras profesional del mundo. ¡Una revolución en la cocina! Ingenioso inventor, este antiguo marinero veterano de la Primera Guerra Mundial, multiplicó el éxito en su fábrica del extrarradio de París. Actualmente, la fábrica sigue a la vanguardia de la innovación.

Un año antes y en las mismas circunstancias, se inventó a orillas del lago Lemán, en Thonon-les-Bains, el cortador de verduras manual de acero : había nacido la Mandolina Bron, que recorrió el mundo de las grandes cocinas profesionales. En más de siete décadas, la fábrica BRON vio el nacimiento de muchos inventos importantes y se especializará en la cocina amistosa con en particular, los tradicionales aparatos de raclette Alpage® y Brézière®.

EN LA ACTUALIDAD

Ahora con el nombre de LOUIS TELLIER, el Grupo continúa la gran historia de la cocina francesa a través de sus innovaciones y sus dos marcas emblemáticas :

LOUIS TELLIER para la preparación culinaria y la cocina amistosa, GOBEL para los utensilios y moldes de pastelería.

Presentes en más de noventa países, estas marcas acompañan, como siempre, el placer de lo hecho a mano.



LOUIS TELLIER

RIEN NE REMPLACE LE FAIT MAIN

LOUIS TELLIER EN CIFRAS



+ DE 100 EMPLEADOS



**+ DE 135 AÑOS
DE EXPERIENCIA**



2 FÁBRICAS EN FRANCIA

Certificadas EPV
«Empresa Patrimonio Vivo»



1 SERVICIO POSTVENTA

Provisión de 1.500 repuestos



1 CENTRO LOGÍSTICO

Centralizado en JOUÉ-LÈSTOURS (37)



+ DE 3 500 REFERENCIAS



**1 ESPACIO
PROFESIONAL DIGITAL**

www.louistellier.fr



**1 SHOW ROOM /
CENTRO DE FORMACIÓN**

Situado en JOUÉ-LÈSTOURS



**EXPORTACIÓN
A MÁS DE 90 PAÍSES**



1 FILIAL en CANADÁ/EE. UU.

Oficina y Logística en
BOUCHERVILLE (QUEBEC)



LOUIS TELLIER

RIEN NE REMPLACE LE FAIT MAIN

**2 TALLERES DE PRODUCCIÓN
3 «SABER HACER»**

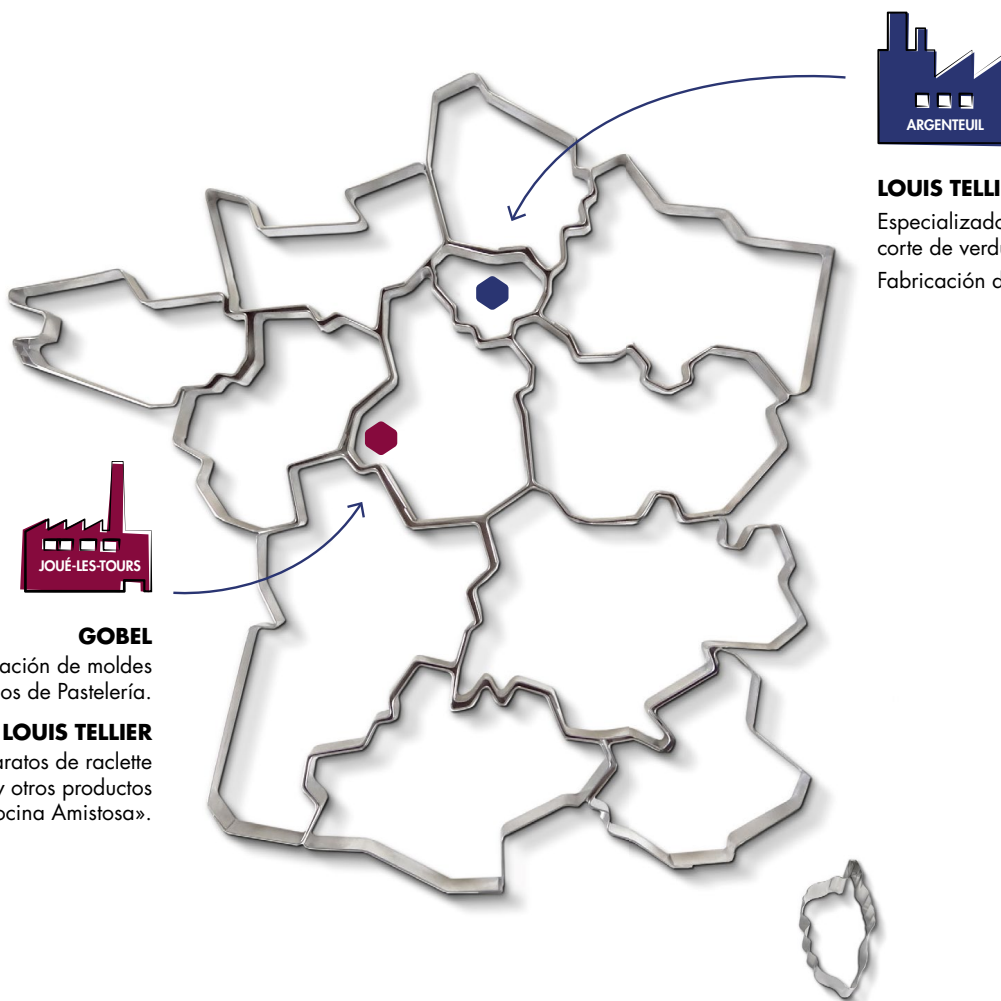

LOUIS TELLIER

Especializado en el material de corte de verduras y frutas.
Fabricación de pasapurés.

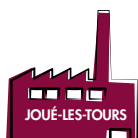

GOBEL

Fabricación de moldes y utensilios de Pastelería.

LOUIS TELLIER

Aparatos de raclette y otros productos «Cocina Amistosa».



Los 2 centros de producción del Grupo Louis Tellier están certificados EPV (Empresa del Patrimonio Vivo). Este sello, auténtica marca de reconocimiento del Estado, se creó para distinguir a las empresas francesas con un saber hacer artesanal y a industriales de excelencia.



Los principales productos de procesado en fresco fabricados en los talleres LOUIS TELLIER están certificados NF. Expedida por un organismo independiente e imparcial, la certificación NF acredita la conformidad de los productos o servicios con los documentos normativos nacionales, europeos e internacionales correspondientes, como normas, completadas, llegado el caso, por especificaciones técnicas que refuerzan el nivel de calidad de la certificación.



El Grupo LOUIS TELLIER es miembro del SYNEG, organización que agrupa y representa a los fabricantes de equipamientos de cocina. Los miembros del SYNEG se seleccionan rigurosamente en base a criterios estrictos. Adoptan un enfoque responsabilidad social y ambiental.



El Grupo LOUIS TELLIER también es miembro de la UNITAM, organización que actualmente agrupa a los fabricantes franceses de productos de calidad en el ámbito de la cocina.



LOUIS TELLIER
RIEN NE REMPLACE LE FAIT MAIN

PREPARACIÓN CULINARIA



LOUIS TELLIER es sin ninguna duda el especialista de la preparación culinaria a través de una amplia gama de equipos productivos, innovadores y creativos, adaptados a las necesidades de las cocinas profesionales, tanto para las colectividades como para la restauración tradicional y las actividades gastronómicas.

Se trata de más de **300 innovaciones para el corte de frutas y verduras en todas sus formas**, algunas de ellas convertidas en auténticas herramientas icónicas.



Una oferta completa de aparatos de medición fiables y precisos. Estancas, mecánicas o electrónicas, nuestras balanzas cubren todas las necesidades y nuestros termómetros todas las tecnologías (infrarrojos, sonda de temperatura, etc.).



Una amplia gama de abrelatas eléctricos o manuales profesionales de eficacia demostrada para mejorar la productividad diaria. De las cocinas escolares a las residencias de la tercera edad, pasando por las cocinas colectivas y los hospitales, nuestros abrelatas conformes con las normas NF responden perfectamente a las exigencias de los profesionales en materia de higiene.

LOUIS TELLIER sigue innovando y ampliando su oferta en utensilios de cocina, con el compromiso de aportar las soluciones más adaptadas para responder a las exigencias técnicas de cada uso y facilitar cada tarea con la precisión y respetando el producto.

LOUIS TELLIER SE COMPROMETE A PRODUCIR Y PROPONER UTENSILIOS
ELIJIENDO LA MEJOR CALIDAD DE MATERIALES, DURADEROS Y SALUDABLES.



LOUIS TELLIER

RIEN NE REMPLACE LE FAIT MAIN

LA COCINA AMISTOSA



LOUIS TELLIER también es una gama de aparatos de Cocina Sencilla de calidad profesional para una utilización en interior o exterior, en función del material o la especialidad.



BRASERO – BARBACOA DE MESA

Barbacoa de mesa profesional de carbón, de calidad, funcional y sencilla.



Brezières

Alpage

RACLETTE

En la pura tradición montañesa, LOUIS TELLIER diseña y distribuye una completa gama de aparatos de raclette.

3 tipos de aparatos en función de la porción de queso elegida (1/4 de rueda, 1/2 rueda o lonchas finas):

La **Brezière** (1/4 de rueda) o el **Alpage** (1/2 rueda), disponibles en las siguientes versiones:

- El Original, color bronce texturado para un estilo tradicional
- La Basalte, color negro texturado para un estilo moderno
- El Inox, con empuñaduras de haya maciza, para un estilo clásico elegante



El aparato de raclette con 4 sartenes
(queso en lonchas)

- Totalmente de acero inoxidable, de una calidad profesional, es robusto y duradero, tiene una toma que permite conectar varios aparatos.



AHUMADOR EN FRÍO

Para pescados, verduras, crustáceos, carnes, etc.
Con o sin resistencia.



PIEDRA DE COCCIÓN CON O SIN SOPORTE

Piedra ollar natural para calentar en el horno (300°C).



PLANCHETTAS

Placa cerámica, quemadores de calentamiento (alcohol gelificado).



FRANCE 1887

GOBEL®

rien ne remplace  le fait main

UTENSILIOS Y MOLDES DE PASTERERÍA



Desde hace 135 años, GOBEL fabrica utensilios y moldes de pastelería, destinados a los profesionales de las actividades gastronómicas y a prestigiosas tiendas especializadas, en más de 90 países.

GOBEL cubre todas las necesidades de los profesionales de la panadería-pastelería con un compromiso: aportar una solución para cada creación, cada receta o especialidad, respetando el producto y ofreciendo materiales de calidad duraderos y saludables.

MOLDES DE PASTERERÍA

Los moldes de pastelería, las placas para pasteles y panes GOBEL disponibles en hojalata, antiadherente y Obsidian, se fabrican en nuestro centro de Joué-lès-Tours (37).



La hojalata: este material ecológico 100% reciclable y saludable ofrece una conductividad excepcional. Nuestros moldes de hojalata, que garantizan un resultado gustativo inigualable, son conocidos por hacer que las masas queden crujientes y doradas por fuera y esponjosas por dentro.

Antiadherente: de calidad profesional, garantizado sin PFOA, con un revestimiento de dos capas, este material es mucho más eficiente que el de una sola capa y garantiza un desmoldado perfecto. Su capa superior cargada de mica hace que sea muy resistente a la abrasión.

Obsidiana: innovación tecnológica, la Obsidiana es un nuevo revestimiento aún más eficiente. Es la excelencia del antiadherente, reforzado con cerámica para una mayor resistencia. 10 años de garantía contra cualquier alteración.

Acero inoxidable: GOBEL ofrece una amplia gama de productos de acero inoxidable «Fabricado en Francia» gruesos, sólidos, resistentes y fáciles de limpiar: círculos, moldes para flanes, marco para tartas ópera, bandejas de bizcochos genoveses, bollos especiados, cortadores, boquillas, etc.

PLACAS DE PASTERERÍA

Las placas de pastelería de GOBEL, indispensables para la cocción en horno, están disponibles en acero inoxidable alimentario, aluminio y aluminio con revestimiento antiadherente. También sirven como soportes de preparación y almacenamiento en armarios frigoríficos y cámaras de fermentación.



UTENSILIOS

GOBEL también ofrece una amplia gama de utensilios y accesorios de ayuda a la pastelería: boles, cubetas, tapetes de cocción y preparación, sifones, mangas pasteleras, rodillos, espátulas, brochas, etc.



CONSEJOS DE UTILIZACIÓN

CONSEJOS DE MANTENIMIENTO

SI 	NO 	INOX	ANTIADHERENTE	HOJALATA	ALUMINIO	ALUMINIO recubierto antiadherente
Lave los moldes con líquido lavaplatos sin usar una esponja abrasiva y séquelos bien						
Apto por lavavajillas						
Posibilidad de poner en el congelador						
Corte directo dentro con un objeto filoso						

CONSEJOS DE COCINA

SI 	NO 	INOX	ANTIADHERENTE	HOJALATA	ALUMINIO	ALUMINIO recubierto antiadherente
Se puede poner en baño maría						
Se puede poner en la llama directamente						
Temperatura máxima de cocción		300°C 570°F	250°C 480°F	250°C 480°F	250°C 480°F	250°C 480°F

LEYENDA CATÁLOGO

Este nuevo formato de catálogo reúne la principal información técnica para responder con precisión a las preguntas y necesidades de sus clientes. Descubra a continuación las claves para la leyenda de los pictogramas.

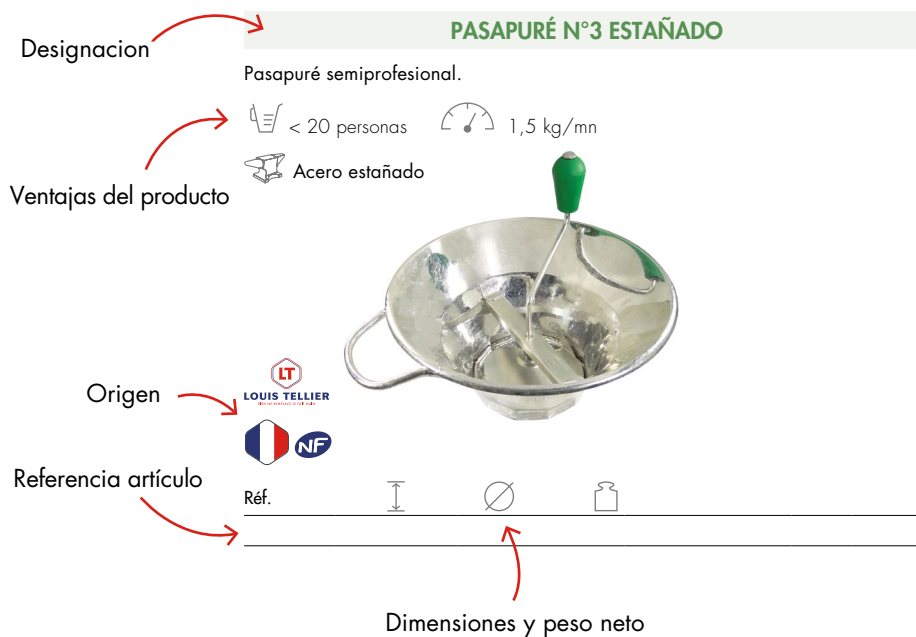

LEYENDA DE LOS PICTOGRAMAS UTILIZADOS



Nuevo catálogo



Mejor venta gama

ORIGEN



FRANCE



JAPÓN

CERIFICACIONES Y NORMAS



NF HYGIÈNE ALIMENTAIRE

Signo de reconocimiento, la marca NF es el resultado de un enfoque voluntario de profesionales decididos a adquirir auténticos compromisos con sus clientes. Ofrece una garantía de la calidad y seguridad de los productos que llevan esta certificación. La marca "NF Hygiène Alimentaire" expedida por AFAQ AFNOR CERTIFICATION, 93571 la plaine Saint-Denis Cedex, Francia, certifica la conformidad con la normativa NF 031 para la aptitud para la limpieza.



NSF INTERNATIONAL

NSF International (National Sanitation Foundation) es un estándar de salud pública independiente de los Estados Unidos. Organiza y desarrolla estándares, certificación de productos, pruebas, auditorías, educación ambiental y servicios de gestión de riesgos ambientales y de salud pública. El Logo en la ficha técnica o empaque sirve como información de si el producto está etiquetado o no, el producto no recibe una referencia específica, solo la lista NSF sirve como prueba con el Nombre y/o Referencia del fabricante.



ÍNDICE IP DE ESTANQUEIDAD
Agua y polvo.



APPCC

Análisis de Peligros y Puntos Críticos de Control es un método de trabajo para controlar la seguridad sanitaria de los productos alimenticios y garantizar la higiene en la cocina. Los productos se desarrollan teniendo en cuenta el procedimiento APPCC, en particular por su buena aptitud para la limpieza.

CARACTERÍSTICAS

Longitud en cm

Alto en cm

Espesor en mm

Ancho en cm

Capacidad

Equipamientos incluidos

Material

Información específica

Diámetro en cm

Peso neto en kg o g

Display disponible

Productividad /rendimiento

Productos complementarios

Específico para los aparatos eléctricos y electrónicos

Potencia

Adaptador de corriente

Tipo de pilas y cantidades incluidas

Específico para las balanzas y termómetros

Rango de temperatura

Pesaje

Precisión

RESUMEN

PREPARACIÓN CULINARIA 14

FRUTAS Y VERDURAS	17
CARNES Y EMBUTIDOS	64
PASTA Y PIZZA	69
TERRINAS Y QUESOS	77
HUEVOS	81
PAN, SANDWICHES Y TORTILLAS	83
ACCESORIOS DE CORTE	85
UTENSILIOS DE COCINA	91
ABRELATAS	97
BALANZAS & TERMÓMETROS	107

COCCIÓN/MANTENIMIENTO TEMPERATURA 116

COCINA	119
--------	-----

CAFETERÍA/BAR/RECEPCIÓN 124

ZUMOS	127
ACCESORIOS DE BAR	129
DESAYUNO/RECEPCIÓN	133

SALA Y BUFFET 136

ACCESORIOS DE MESA	139
ACCESORIOS PARA EL BUFFET	141
ACCESORIOS DE SERVICIO	143
ACCESORIOS PARA PEDIDOS	144

CONSERVACIÓN 146

ENVASADORA AL VACÍO	149
REGLAS Y DISPENSADORES	150
DESHIDRATADORES	151
CAJA DE ESPECIAS	153

HIGIENE 156

DISPENSADORES	159
---------------	-----

AMISTOSO 162

MÁQUINAS DE RACLETTE Y FONDUES	165
BRASEROS Y PLANCHETTAS	171
BROCHETAS	174
AHUMADERO	176

ANTIADHERENTE 178

BANDEJAS DE COCCIÓN	181
MOLDES DE PAN Y BANDEJAS DE HORNEAR	184
BANDEJAS DE PIZZA Y MOLDE DE HORNO	186
MOLDES PLEGABLES PARA PATE	187
MOLDES CAKE	188
BRIOCHE	189
MOLDES PARA TARTAS Y PASTELES	191
MOLDES MANQUE Y MILLASSON	198
MOLDES PARA GENOISE	200
MOLDES PARA SAVARIN, CHARLOTTE Y MÓDULOS TEMÁTICOS	201
MONOPORCIONES Y PASTELES	204
RECETAS Y PAQUETES DE KITS	207
PLACAS MÚLTIPLES PARA HORNEAR	209

ANTIADHERENTE OBSIDIAN 212

BANDEJAS Y MOLDES OBSIDIAN	215
----------------------------	-----

HOJALATA 220

BANDEJAS DE COCCIÓN/PAN/PIZZA	223
MOLDES PLEGABLES PARA PATE	226
MOLDES CAKE	227
BRIOCHE	228
MOLDES PARA TARTAS Y PASTELES	231
MANQUE Y MILLASSON MOLDES	235
MOLDE PARA GENOISE Y MÓDULOS TEMÁTICOS	237
MONOPORCIONES Y PASTELES	239

ORIGINE 242

MOLDES BIODEGRADABLES "ORIGINE"	243
---------------------------------	-----

ACERO INOXIDABLE **244**

ARO DE TARTA CON BORDES	246
ARO DE TARTA SIN BORDES	249
FORMAS DE ACERO INOXIDABLE	252
MARCO A OPERA Y GENOISE	261
MOLDE TRONCO DE NAVIDAD	263

BANDEJAS DE PASTERERÍA **264**

BANDEJAS DE PASTERERÍA	267
------------------------	-----

UTENSILIOS DE REPOSTERÍA **270**

BOL PARA MEZCLAR	272
TELAS PARA HORNEAR Y RODILLOS DE REPOSTERÍA	273
BATIDORES, ESPÁTULAS, CUCHARAS Y BROCHAS	275
MANGAS PASTERERAS Y BOQUILLAS	278
SIFÓNES Y RECARGAS	283
ESPATULA CORTOPASTA	284
CORTAPASTA	286
CEDAZOS, ESPOLVOREADORES, DISPOSITIVOS DE DOSIFICACIÓN Y COLADOR "CHINO"	289
OTRAS HERRAMIENTAS	293

ESPOSITORES Y SOPORTE DE VENTAS **296**

ESPOSITORES, CABALLETTE, REGARGA RECETAS Y POSTER	298
---	-----

CONTACTO

Louis Tellier SAS

+33 (0)1 34 11 38 38

info@louistellier.fr

Sede de la empresa : 116 Quai de Bezons
95100 Argenteuil – Francia

Showroom : 5 rue Debrou - ZI de la Gare
37300 Joué-lès-Tours – Francia

WEB

Siga nuestras noticias



www.louistellier.fr

En LouisTellier.fr podrá consultar las vistas despiezadas, las instrucciones y las fichas técnicas buscando por la referencia del artículo.

VÍDEOS

Escanee el **CÓDIGO QR*** con su smartphone o su tableta : el video se abre directamente.

Acceda también a todos nuestros videos en el canal de YouTube Groupe Louis Tellier.

* Puede descargar la aplicación gratuita dedicada (Flashcode, QR Code Reader, QR Code, etc.)

¡Haga la prueba aquí!





PREPARACIÓN CULINARIA

FRUTAS Y VERDURAS	17
• Pasapurés	17
• Puré y coulis	20
• Mandolinas	23
• Corta-patatas	27
• Cortadoras de tomates y cítricos	33
• Corta lechuga	34
• Cortadoras de verduras y especias frescas	37
• Peladores	45
• Cortadoras de manzanas y cítricos	53
• Cortadoras de frutas exóticas	57
• Escultura de frutas y hortalizas	61
CARNES Y EMBUTIDOS	64
• Picadora y embutidora	64
PASTA Y PIZZA	69
• Máquinas de pasta y accesorios	69
• Accesorios de pizza	75
TERRINAS Y QUESOS	77
HUEVOS	81
PAN, SANDWICHES Y TORTILLAS	83
ACCESORIOS DE CORTE	85
• Tabla de cortar	85
• Guante de protección, afiladores, tijeras	90
UTENSILIOS DE COCINA	91
• Espátulas y cucharas de haya	91
• Espátulas y cucharas compuestas	92
• Inox	93
ABRELATAS	97
• Eléctrico	97
• Manuales	101
BALANZAS & TERMÓMETROS	107
• Balanzas	107
• Termómetros	111

PASAPURÉ PROFESSIONAL N°5



LOUIS TELLIER



Las rejillas de 1 y 1,5 mm : para salsas y coulis.



Las rejillas de 2 y 3 mm : para las purées, copas y compotas.



Las rejillas de Ø 4 mm : para las sopas de pescado y las verduras fibrosas como puerros y espinacas.



Doble aplastado para una productividad de 5 kg/min

Totalmente desmontable para una higiene perfecta

Acero **estañado**

Adecuado hasta para **50 personas**

Rejillas **intercambiables**

Buena estabilidad gracias a **los ganchos de sujeción**

En 1947, Louis Tellier revolucionó el mundo de la cocina creando el primer pasapuré profesional. El molinillo triturador LT cosechó rápidamente un gran éxito con los restauradores. Disponible en modelo reducido, el molinillo LT pone los purés, las sopas, las compotas y los coulis al alcance de todas las manos. Igual de eficaz y robusto, en el año de su 65º aniversario, el molino N°5 contribuyó al récord del puré de patatas más grande del mundo, establecido el 29 de septiembre de 2012, según la famosa receta de Joël Robuchon.

PASAPURÉ

Permite preparar coulis, compotas y purés con facilidad. Equipado con 3 rejillas de diferentes tamaños. Modelo de hogar.

3 rejillas : 1,5 - 2,5 - 4 mm

Acero inoxidable

1 kg/mn

BEST SELLER



LOUIS TELLIER

Réf.
 N3004X 40 24,5 17 0,95 Ø 24 cm - Packaging Louis Tellier

PASAPURÉ N°2 ESTAÑADO

Permite preparar coulis, compotas y purés con facilidad. Equipado con 3 rejillas de diferentes tamaños. Modelo de hogar.

3 rejillas : Ø 1,5 - 2,5 - 4 mm

Acero estañado

1 kg/mn



LOUIS TELLIER



Réf.
 S2 24 22 1,1

PASAPURÉ N°3 ESTAÑADO

Pasapuré semiprofesional.

< 20 personas

3 rejillas : Ø 1,5 - 2,5 - 4 mm

Acero estañado

1,5 kg/mn

BEST SELLER



LOUIS TELLIER



Réf.
 S3 31 25 1,5

REJILLAS ESTAÑADAS PARA PASAPURÉ N°2 Y N°3

Ø 1,5 mm para coulis , Ø 2,5 mm para purés , 4 mm oval para mozzarella. Adaptadas a los pasapurés estañado n°3, intercambiables.

Acero estañado

1,5 kg/mn

BEST SELLER



LOUIS TELLIER

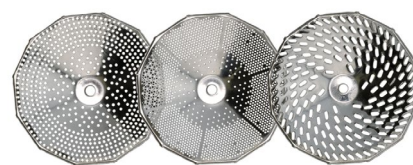

Réf.						
S3015	14	14	2	0,06	Ø 1,5 mm	S3 / S2
S3025	14	14	2	0,06	Ø 2,5 mm	S3 / S2
S3040	14	14	2	0,06	Ø 4 mm	S3 / S2

PASAPURÉ N°3 INOX.

Pasapuré semiprofesional.

< 20 personas

3 rejillas : Ø 1,5 - 2,5 - 4 mm

Acero inoxidable

1,5 kg/mn

BEST SELLER



LOUIS TELLIER



Réf.
 X3-F 31 25 1,7

REJILLAS PARA PASAPURÉ N°3 INOX.

Ø 1,5 mm para coulis , Ø 2,5 mm para purés , 4 mm oval para mozzarella. Adaptadas a los pasapurés inox n°3, intercambiables.

Acero inoxidable

1,5 kg/mn



LOUIS TELLIER

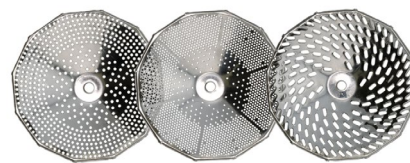

Réf.						
X3015	14	14	2	0,06	Ø 1,5 mm	X3-F
X3025	14	14	2	0,06	Ø 2,5 mm	X3-F
X3040	14	14	2	0,06	Ø 4 mm	X3-F

PASAPURÉ N°5 ESTAÑADO

Modelo para restaurante. Doble aplastado para productividad máxima. Rejillas intercambiables.

< 50 personas

Acero estañado

5 kg/mn



Réf.					
M510	37	32	3,3	Con rejilla Ø 1 mm. Bajo demanda.	
M515	37	32	3,3	Con rejilla Ø 1,5 mm. Bajo demanda.	
M520	37	34	3,3	Con rejilla Ø 2 mm. Bajo demanda.	
M530		37	32	3,3	Con rejilla Ø 3 mm
M540	37	32	3,3	Con rejilla Ø 4 mm. Bajo demanda.	
M500	37	34	3,3	Sin rejilla	

PASAPURÉ N°5 INOX.

Modelo para restaurante. Doble aplastado para productividad máxima. Rejillas intercambiables.

< 50 personas

Acero inoxidable

5 kg/mn



Réf.					
X510	37	32	3	Con rejilla Ø 1 mm. Bajo demanda.	
X515	37	32	3	Con rejilla Ø 1,5 mm. Bajo demanda.	
X520	37	32	3	Con rejilla Ø 2 mm. Bajo demanda.	
X530		37	32	3	Con rejilla Ø 3 mm
X540	37	32	3	Con rejilla Ø 4 mm. Bajo demanda.	
X500	37	32	3	Sin rejilla	

REJILLAS ESTAÑADAS PARA PASAPURÉ N°5

Adaptadas a los molinos n°5 estañados, intercambiables.

Acero estañado

5 kg/mn



Réf.					
M5010	20	20	8	0,6	Ø 1 mm
M5015	20	20	8	0,6	Ø 1,5 mm
M5020	20	20	8	0,6	Ø 2 mm
M5030	20	20	8	0,6	Ø 3 mm
M5040	20	20	8	0,6	Ø 4 mm

REJILLAS PARA PASAPURÉ N°5 INOX.

Adaptadas a los molinos n°5 de inox, intercambiables.

Acero inoxidable

5 kg/mn



Réf.		
X5010	0,65	Ø 1 mm
X5015	0,65	Ø 1,5 mm
X5020	0,65	Ø 2 mm
X5030	0,65	Ø 3 mm
X5040	0,65	Ø 4 mm

PASAPURÉ N°10 ESTAÑADO

Para grandes cocinas. Permite elaborar salsas, purés, compotas o sopas sin esfuerzo y en grandes cantidades.

< 200 personas

Acero estañado

10 kg/mn



Réf.					
P1010	39	80	13	Sobre pie tubo. Con rejilla Ø 1 mm. Bajo demanda.	
P1015	39	80	13	Sobre pie tubo. Con rejilla Ø 1,5 mm. Bajo demanda.	
P1020	39	80	13	Sobre pie tubo. Con rejilla Ø 2 mm. Bajo demanda.	
P1030		39	80	13	Sobre pie tubo. Con rejilla Ø 3 mm
P1040	39	80	13	Sobre pie tubo. Con rejilla Ø 4 mm. Bajo demanda.	
P1000	39	80	13	Sobre pie tubo. Sin rejilla	

REJILLA PARA PASAPURÉ ESTAÑADO N°10

Adaptadas a los pasapurés estañado n°10, intercambiables.

Acero estañado

10 kg/mn



Réf.					
P10010	37	22,5	10	0,8	Ø 1 mm
P10015	22	22,5	10	0,8	Ø 1,5 mm
P10020	22,5	22,5	10	0,8	Ø 2 mm
P10030	22,5	22,5	10	0,8	Ø 3 mm
P10040	22,5	22,5	10	0,8	Ø 4 mm

PASAPURÉ ELÉCTRICO INOX.

Molino eléctrico de acero inoxidable, ideal para todo tipo de preparación (sopa, salsa, puré). Te permite hacer 5 kg de preparación en 1 minuto. Con marcha atrás.

< 500 personas

Acero inoxidable

5 kg/mn

50/60 Hz - 600 W



Réf.				
EX5M130	37	108	23,5	Monofásico. Con rejilla : Ø 3 mm. Bajo demanda.
EX5M100	37	108	23,5	Monofásico. Sin rejilla
EX5T100	37	108	23,5	Trifásico. Sin rejilla
EX5T130	37	108	23,5	Trifásico. Con rejilla: Ø 3 mm

REJILLAS PARA PASAPURÉ ELÉCTRICO INOX.

Adaptadas a los molinos electricos EX5, intercambiables.

Acero inoxidable

5 kg/mn



Réf.					
EX5010	20	20	8,5	0,49	Ø 1 mm
EX5015	20	20	8,5	0,56	Ø 1,5 mm
EX5020	20	20	8,5	0,57	Ø 2 mm
EX5030	20	20	8,5	0,53	Ø 3 mm
EX5040	20	20	8,5	0,5	Ø 4 mm

PRENSAPURÉ CON PALANCA PROFESIONAL

Parrilla fija 2,5 mm. Con palanca profesional.

Acero inoxidable



LOUIS TELLIER

Réf.				
N3028	29	13,5	10,5	0,65

PRENSAPURÉ CON PALANCA

Con muescas para adaptarse sobre el recipiente. Con palanca.

3 rejillas : Ø 2 - 5 - 7 mm

Acero inoxidable



LOUIS TELLIER

Réf.				
N3024	32	8	16,5	0,62

PISÓN TAMIZ PRENSAPURÉ

Prensa perfectamente.
Doble función: aplasta y prensa.

Acero inoxidable



LOUIS TELLIER

Réf.				
N3025	10,5	9	25	0,3

MOLINO DE TOMATE MANUAL

Exprimidor manual de tomates y frutas (frambuesas, grosellas, grosellas negras, manzanas al horno, etc.)

Cuerpo de acero fundido, acero inoxidable y resina acetálica



Réf.				
CT3X	30	22	32	2,41

MOLINO DE TOMATE ELÉCTRICO

Prensa de tomates y frutas equipada con motor eléctrico.

Cuerpo de acero fundido, acero inoxidable y resina acetálica



Réf.				
CT3X-EL	50	23	32	10

EXTRACTOR DE JUGO MANUAL

Exprimidor/molino de tomate manual grande. Separa el jugo de las pieles, pepitas y residuos.

Rejilla Ø 1 mm. Fijación de abrazadera.

PP, aluminio, acero inoxidable



Ref.			
N3031	21,3	50	1,84

KIT 3 REJILLAS PARA EXTRACTOR DE JUGO MANUAL

Separa el jugo de las cascaras, pepitas y residuos. Ø6 mm: calabaza, Ø3 mm: uvas y Ø1,1 mm: tomates y frutos rojos.

Acero inoxidable



Ref.					
N3032	15	15	13,5	0,8	N3031

LA MANDOLINA PROFESIONAL BRON COUCKE



LOUIS TELLIER
BIEN NE REMPLACE LE FAIT MAIR



Siempre lista para el empleo

Apoyo borde de mesa (patentado)

Bloques **afiladores fijos**.
 Cuchilla ondulada para cortes ondulados.

Totalmente de acero inoxidable, cuchilla templada, afilado **especializado en Thiers**

4 patines antideslizantes para una estabilidad perfecta

Grosor de rebanadas y obleas **ajustable**

Nuestras mandolinas son ideales para realizar :

- Rodajas y arandelas de frutas y verduras de diferentes grosores
- Arandelas onduladas
- Gaufrettes y chips
- Julianas
- Cabellos de ángel
- Patatas pajas, patatas cerilla y fritas

Opcional : el carro protector y el empujador de seguridad.

MANDOLINA VIVALDI

Espesor de rodajas regulable. Juliana 2 mm y patatas fritas 10 mm.

- 2 bloques cónicos, empujador de seguridad, pie antideslizante, asidero
- Acero inoxidable y ABS



Réf.				
10000	40	13,5	5,5	1,41

MANDOLINE DEL CHEF

Para rodajas lisas o gofradas, palitos, juliana y cabello de ángel 1 - 2 - 4 - 7 y 10 mm. Grosor regulable. Reversible.

- Patas y asas antideslizantes. 4 bloques cónicos intercambiables, hoja lisa, hoja en relieve. Empujador.
- Acero inoxidable y ABS



Réf.				
15000	40	13,5	5,5	1,5

MANDOLINA SUPER PROFESIONAL

Espesor regulable de rodajas y obleas. Rodajas lisas o repujadas, cabello de ángel, patatas fritas y juliana 1 - 2 - 4 - 7 y 10 mm.

- Soporte de borde de mesa, 5 bloques cónicos intercambiables, hoja lisa, hoja en relieve. Empujador.
- Acero inoxidable y ABS



Réf.				
25000	40	11,5	4	1,5

BLOQUE CUCHILLAS

Para un corte perfecto.

- ABS



Réf.						
10202	10	0,8	2,5	0,03	2 mm	10000 / 25000 / 15000
10210	10	1,8	2,5	0,03	10 mm	10000 / 25000 / 15000
10211	13	9	3,5	0,03	2,4,7,10 mm	10000 / 25000 / 15000

MANDOLINA PROFESIONAL CON CARRO - PEINE 3 & 10 MM

Para rodajas lisas o gofradas, palitos o juliana. Grosor regulable. Lisas o gofradas rodajas, patatas y juliana.

- Soporte de borde de mesa, 2 bloques cónicos integrados, hoja lisa, hoja en relieve
- Acero inoxidable



Réf.					
20638CHB	41	13,5	4,5	1,8	Carro con asa de plástico
20638CHBB	41	13,5	4,5	1,8	Carro con asa de madera

MANDOLINA PROFESIONAL SIN CARRO

Para rodajas lisas o gofradas, palitos o juliana. Grosor regulable. Lisas o gofradas rodajas, patatas y juliana.

- Soporte de borde de mesa, 2 bloques cónicos, hoja lisa, hoja en relieve Sin carro ni empujador
- Acero inoxidable



Réf.					
20638B	41	13,5	4,5	1,5	3 & 10 mm (pajas y papas)
20644B	41	13,5	4,5	1,5	3 & 7 mm (cerillos y pajas)
20660B	41	13,5	4,5	1,5	2 & 4,5 mm (pajas y juliana)

PULSADOR DE SEGURIDAD UNIVERSAL

Protege contra los cortes. Apropiado para corte gofrado.

ABS



Réf.	Ø	h	peso	Descripción
10201	9	5	0,11	Para todas las mandolinas Louis Tellier

CARRO PROTECTOR

Protege contra los cortes. Carro protector (empujador) no sirve para el corte gofrado.

Acero inoxidable, mango PP



Réf.	L	A	h	peso	Material	Compatibilidad
30300	17	12	6	0,37	Asa de plástico	Mandolinas pro & super pro
30400	17	12	6	0,4	Asa de madera	Mandolines pro & super pro

CORTADOR A RODAJAS EXPRESS BIDIRECCIONAL

Espesor de corte regulable: de 1,2 a 5 mm. Para cortar de manera rápida y segura todas las frutas y verduras.

Empujador completo (carro+empujador+cilindro) : L : 15 cm - A : 18 cm.

Boquilla de carga Ø 89 mm. Empujador de HDPE.

Acero inoxidable, HPDE



Réf.	L	A	h	peso
TAT	54	12	13	3,4

RALLADORA PARA REPOLLO

Madera de haya



Réf.	L	A	h	peso
N7010	60	23	9	2,24

MANDOLINA JAPONESA - GAMA PREMIUM

Ancho de corte ajustable (hoja lisa) de 0,5 a 5 mm. Resistencia térmica : 70°C

Gran pie antideslizante, 1 empujador ergonómico y 3 peines de adelgazamiento (1 - 2 - 4 mm)

ABS, acero inoxidable



Réf.	Best Seller	L	A	h	peso	Ancho
64JB		32	11	4	0,39	Ancho 65 mm
95JB		36,5	14,5	4,5	0,61	Ancho 95 mm
120JB		32,5	15	5	0,6	Ancho 120 mm

MANDOLINA JAPONESA - GAMA ESTÁNDAR

Resistencia térmica: 70°C. Espesor de corte ajustable de 0,5 a 5 mm.

3 peines de aclareo (1 - 2 - 4 mm) y 1 empujador de seguridad

ABS, acero inoxidable



Réf.	Best Seller	L	A	h	peso	Ancho
8486JAPP		32	12	5	0,36	Ancho 65 mm
8490JAPP		32	10	7	0,52	Ancho 65 mm con recuperador
8485JAPGN		35	15	4	0,45	Ancho 95 mm

ACCESORIOS PARA MANDOLINA JAPONESA

Para un corte fino.

Acero inoxidable

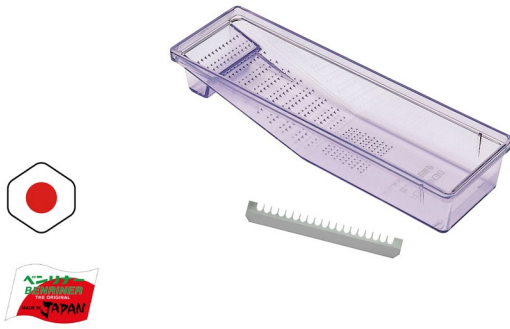

Réf.						
8485FI	14,5	2	0,1	0,02	Cuchilla cortadora fina, para mandolina grande	8485JAPGN / 95JB
8485LA	14,5	2	0,1	0,02	Cuchilla cortadora mediana, para mandolina grande	8485JAPGN / 95JB
8485MO	14,5	2	0,1	0,02	Cuchilla cortadora grande, para mandolina grande	8485JAPGN / 95JB
8486FI	10,5	2	0,1	0,02	Cuchilla cortadora fina, para mandolina pequeña	8486JAPP / 64JB
8486LA	10,5	2	0,1	0,02	Cuchilla cortadora grande, para mandolina pequeña	8486JAPP / 64JB
8486MO	10,5	2	0,1	0,02	Cuchilla cortadora mediana, para mandolina pequeña	8486JAPP / 64JB

RASCADOR INOX PARA TRUFAS Y VERDURAS

Espesor de corte regulable con moleta. Trufas, champiñones, parmesano, chocolate...

Hoja dentada

Acero inoxidable



Réf.				
102ORT	18	8	2	0,1

MANDOLINA PARA TRUFAS

Anchura de corte: 5,8 cm. Espesor de corte regulable y precisa: 0,1 a 4 mm.

Acero inoxidable



Réf.				
1010CT	18	7	2	1,1

RASCADOR DE MADERA PARA TRUFAS Y VERDURAS

Espesor de corte regulable con moleta. Trufas, champiñones, parmesano, chocolate...

Hoja dentada

Acero inoxidable, madera



Réf.				
1030RT	20,7	9	2,5	0,11

CORTA-PATATAS PROFESIONAL



LOUIS TELLIER
BIEN NE REMPLACE LE FAIT MAIN

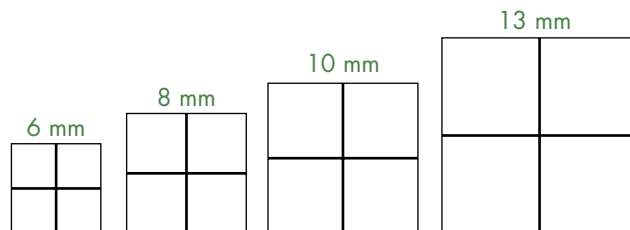

Totalmente de **acero inoxidable**, resbaladera PA

Productividad : **4-5 kg/min**

Asa ergonómica : potencia multiplicada sin esfuerzo

7 cuchillas **intercambiables sin herramientas**

Disponible sobre **base antideslizante**, sobre **base APPCC con ventosas**, sobre **pie**, en versión **mural** y para **atornillar**

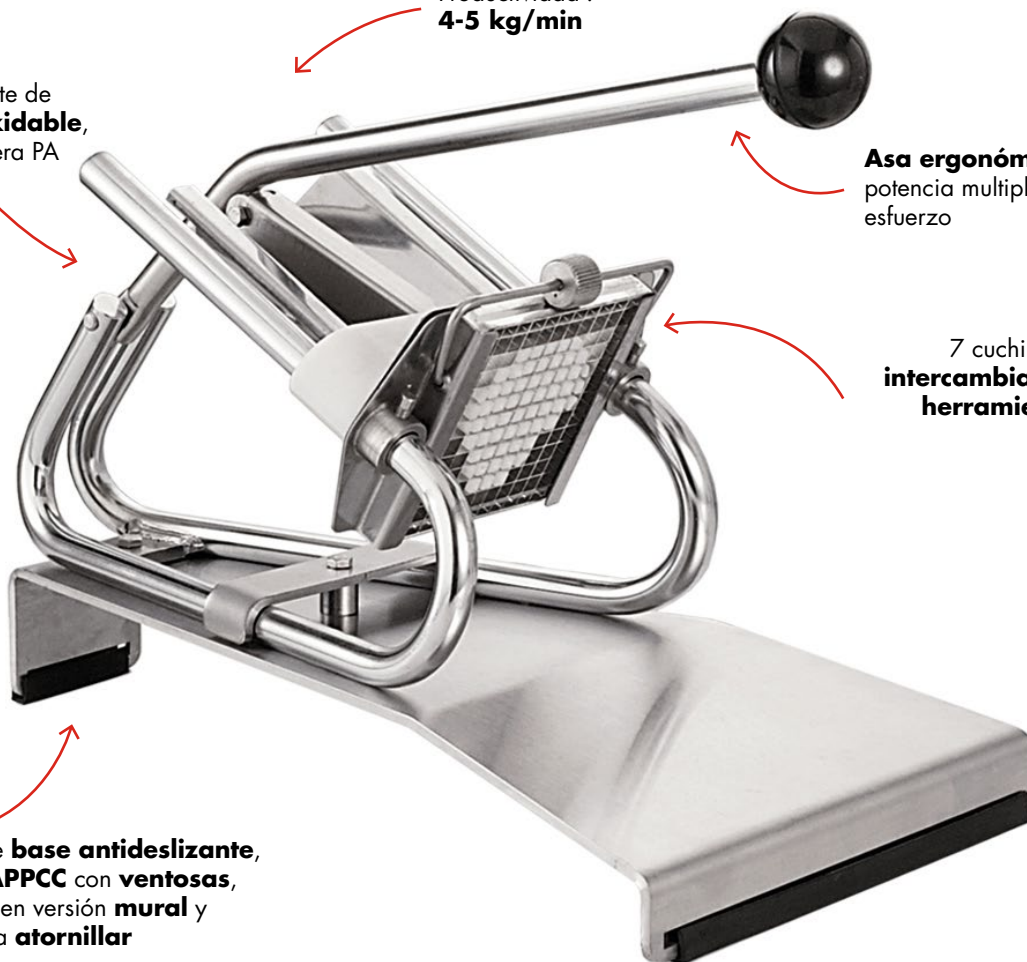

Las patatas fritas caseras estan famosas por su sabor y su increíble textura, a todos les gustan. Las patatas deben pelarse y prepararse in situ, no se trata de proponer patatas fritas precocinadas congeladas.

En 1960, Jean Tellier (hijo de Louis Tellier) creó un cortador de patatas fritas de nuevo diseño que presentó en la Feria de París. Rápidamente, se fabricaron varios cientos de miles de ejemplares y el cortador de patatas fritas dio la vuelta al mundo. Premiado en el concurso internacional de diseño de Estocolmo, la invención de Tellier contribuyó tanto al éxito mundial de «patatas fritas a la francesa» como a la fama internacional de la empresa.

CORTA-PATATAS DE PARED

Altura funcional de trabajo, para alta productividad.

Acero inoxidable, acero cromado, epoxi, cremallera PA

4-5 kg/min.



LOUIS TELLIER



Réf.					
CP06	65	54	90	10,05	Con cuchillo y empujador : 6 mm. Bajo demanda.
CP08	65	54	90	10,05	Con cuchillo y empujador : 8 mm
CP10	65	54	90	10,05	Con cuchillo y empujador : 10 mm
CP13	65	54	90	10,05	Con cuchillo y empujador : 13 mm. Bajo demanda.
CP00	65	54	90	10,05	Sin cuchillo y empujador

CORTA-PATATAS ATORNILLAR

Para fijar sobre mesa. Compacto. Agarre cómodo. Gran productividad.

Acero inoxidable, acero cromado, PA

4-5 kg/min.



LOUIS TELLIER



Réf.					
C06	30	18	26	4	Con cuchillo y empujador : 6 mm
C08	30	18	26	4	Con cuchillo y empujador : 8 mm.
C10	30	18	26	4	Con cuchillo y empujador : 10 mm
C13	30	18	26	4	Con cuchillo y empujador : 13 mm
C00	30	18	26	3,74	Sin cuchillo y empujador

CORTA-PATATAS CON BASE EPOXI

Agarre cómodo. Gran productividad. No requiere fijación.

Acero inoxidable, acero cromado, epoxi, PA

4-5 kg/min.



LOUIS TELLIER



Réf.					
CS06	44	25	35	6,5	Con cuchillo y empujador : 6 mm
CS08	44	25	35	6,5	Con cuchillo y empujador : 8 mm
CS10	44	25	35	6,5	Con cuchillo y empujador : 10 mm
CS13	44	25	35	6,5	Con cuchillo y empujador : 13 mm. Bajo demanda.
CS00	44	25	35	6,5	Sin cuchillo y empujador

CORTA-PATATAS PROFESIONAL BASE INOX.

Agarre cómodo. Gran productividad. No requiere fijación.

Acero inoxidable, PA

4-5 kg/min.



LOUIS TELLIER



Réf.					
CX06	44	25	35	6,7	Con cuchillo y empujador : 6 mm. Bajo demanda.
CX08	44	25	35	6,7	Con cuchillo y empujador : 8 mm
CX10	44	25	35	6,7	Con cuchillo y empujador : 10 mm
CX13	44	25	35	6,7	Con cuchillo y empujador : 13 mm
CX00	44	25	35	6,7	Sin cuchillo y empujador

CORTA-PATATAS HACCP

Sobre tabla HDPE500 con ventosas para una estabilidad óptima. Agarre cómodo. Alta productividad.

Acero inoxidable, tabla de HDPE, PA

4-5 kg/min.

LOUIS TELLIER

Réf.					
CX06-P	42	24	30	6	Con cuchillo y empujador : 6 mm. Bajo demanda.
CX08-P	42	24	30	6	Con cuchillo y empujador : 8 mm
CX10-P	42	24	30	6	Con cuchillo y empujador : 10 mm
CX13-P	42	24	30	6	Con cuchillo y empujador : 13 mm. Bajo demanda.
CX00-P	42	24	30	6	Sin cuchillo y empujador.

CORTA-PATATAS DE PARED

Para fijar a la pared. Gran productividad.

Acero inoxidable, acero cromado, epoxi, PA

4-5 kg/min.

LOUIS TELLIER

Réf.					
CM06	40	17,5	29	4	Con cuchillo y empujador : 6 mm. Bajo demanda.
CM08	40	17,5	29	4	Con cuchillo y empujador : 8 mm.
CM10	40	17,5	29	4	Con cuchillo y empujador : 10 mm
CM13	40	17,5	29	4	Con cuchillo y empujador : 13 mm.
CM00	40	17,5	29	3,95	Sin cuchillo y empujador

CORTA-PATATAS - COMPACT PRO

Calidad profesional. Funcional por su pequeño tamaño (restaurantes, food-truck ...). Precisión de corte 10x10mm. Calibración de productos: pequeños y medianos. Fácil de usar. Sólido. Ganancia de productividad.

Acero inoxidable y acero niquelado

3-4 kg/min.

LOUIS TELLIER

Réf.					
CSP10	25	13	21	1,9	Con cuchillo 10x10mm y empujador

REJILLA + EMPUJADOR DE CORTA PATATAS - COMPACT PRO

Acero estañado, PP y PA

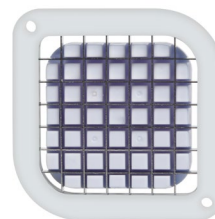
LOUIS TELLIER

Réf.						
LT20A009	9,5	9,5	1,5	0,1	10x 10 mm	CSP10

CORTA-PATATAS DOMÉSTICO

Modelo domestico. Fijación con ventosa.

Acero estañado, PP

LOUIS TELLIER

Réf.				
N3023VLT	26	9	12,5	0,9

KIT CUCHILLOS + EMPUJADOR DOMÉSTICO

Acero estañado, PP



Réf.						
N3023-09	7,5	8	2	0,11	9 x 9 mm	N3023V / N3023VLT
N3023-12	7	8	2,5	0,11	12 x 12 mm	N3023V / N3023VLT

KIT CUCHILLO ESTAÑADO + EMPUJADOR

Compatible con corta-patatas de acero estañado.

Para corta-patatas

Acero estañado, PP

BEST SELLER



LOUIS TELLIER



Réf.			
C006	0,24	6 x 6 mm	CP / C / CS / CM
C008	0,24	8 x 8 mm	CP / C / CS / CM
C010	0,24	10 x 10 mm	CP / C / CS / CM
C013	0,24	13 x 13 mm	CP / C / CS / CM
C020	0,24	10 x 20 mm	CP / C / CS / CM
C022	0,24	20 x 20 mm	CP / C / CS / CM
C00K	0,24	Potatoes	CP / C / CS / CM

CUCHILLO ESTAÑADO

Compatible con corta-patatas de acero estañado.

Acero estañado

BEST SELLER



LOUIS TELLIER



Réf.			
CF106	0,18	6 x 6 mm	CP / C / CS / CM
CF108	0,175	8 x 8 mm	CP / C / CS / CM
CF110	0,162	10 x 10 mm	CP / C / CS / CM
CF113	0,15	13 x 13 mm	CP / C / CS / CM
CF120	0,14	10 x 20 mm	CP / C / CS / CM
CF122		20 x 20 mm	CP / C / CS / CM
CF1K	0,17	Potatoes	CP / C / CS / CM

EMPUJADOR PARA CORTA-PATATAS

PP



LOUIS TELLIER



Réf.			
CF206	0,03	6 x 6 mm	CP / C / CX / CS / CM
CF208	0,04	8 x 8 mm	CP / C / CX / CS / CM
CF210	0,04	10 x 10 / 20 x 20 / 10 x 20 mm	CP / C / CX / CS / CM
CF213	0,03	13 x 13 mm	CP / C / CX / CS / CM
CF2K	0,3	Potatoes	CP / C / CX / CS / CM

KIT CUCHILLO INOX. + EMPUJADOR

Compatible con corta-patatas de inox.

Para corta-patatas

Acero inoxidable

BEST SELLER



LOUIS TELLIER



Réf.			
C006X	0,19	6 x 6 mm	CX
C008X	0,19	8 x 8 mm	CX
C010X	0,15	10 x 10 mm	CX
C013X	0,3	13 x 13 mm	CX

CUCHILLO INOX.

Compatible con corta-patatas de inox.

Acero inoxidable



LOUIS TELLIER



Réf.			
CF306	0,17	6 x 6 mm	CX
CF308	0,02	8 x 8 mm	CX
CF310	0,02	10 x 10 mm	CX
CF313	0,12	13 x 13 mm	CX

CORREDERA PARA CORTA-PATATAS

PA



LOUIS TELLIER



Réf.					
CF0007	16	8	3,5	0,1	COUPE FRITES

PAPAS FRITAS EN ESPIRAL - SOPORTE BRIDA

Espesor de corte : 2,25 mm. ¡Innovación : patata frita en espiral sobre un pincho!

Acero inoxidable

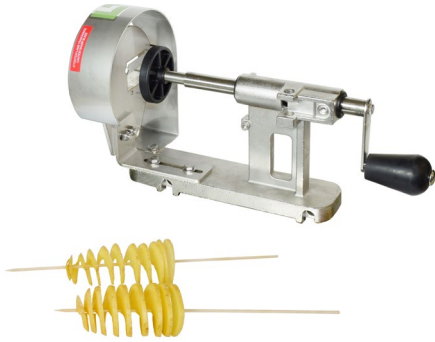
LOUIS TELLIER

Réf.					
CNX225	33	13	45	3,87	SopORTE brida

PAPAS FRITAS EN ESPIRAL - CON VENTOSAS

Espesor de corte: 2,25 mm. ¡Innovación: patata frita en espiral sobre un pincho!

Acero inoxidable



LOUIS TELLIER

Réf.					
CNX225-V	33	15	22	4,04	Con ventosas

CUCHILLO PARA PAPAS FRITAS EN ESPIRAL

Cuchilla para Spirale Frit'n Chips. 2 espesores de corte.

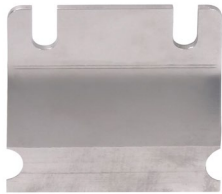
Acero inoxidable

LOUIS TELLIER

Réf.			
CNX225-L	0,024	Espesor de corte: 2,25 mm	CNX225 / CNX225-V
CNX450-L	0,024	Espesor de corte : 4,5 mm	CNX225 / CNX225-V



CORTADOR A RODAJAS PRO TOMATES Y MOZZARRELLA



Nada de pérdida de material :
11 cuchillas retorcidas
para **ninguna adherencia**

Cómodo :
Carro elevado para expulsar lonchas
en un contenedor GN H65. Dispositivo con
cuña de mesa y pasador de seguridad.



Ganancia de productividad :
3,5 kg/min - 1 ud./ 2,5 seg.
Corta todo el producto fácilmente
en **un solo gesto** en rebanadas
regulares de 5,5 mm

Higiénico :
Todo acero inoxidable
y empujador de HDPE,
fácil de limpiar

Respeto del producto :
Empujador ajustado + cuchillos con
dientes finos y apretados para **perforar
perfectamente** piel y carne delicada.

Este cortador de tomate mozzarella se adapta a las necesidades de grandes producciones como comunidades y restaurantes de comida rápida.

Ideal para pizzas, ensaladas, hamburguesas o sándwiches.

CORTADOR A RODAJAS TOMATES Y MOZZARELLA

La 1ra Mozzarella Rodajas. 11 cuchillas especialmente afiladas para cortar y respetar la carne tierna. Rebanadas regulares, Carro corredero sobre PEAD, elevado para expulsar el producto rebanado en un cubeta GN H65. Para comunidades, pizzerías, comida rápida ...

Acero inoxidable, HPDE y PP

3,5 kg/min. 1 pz. / 2,5 seg.



Réf.	↔	↗	⊥	📦	🔍
CT-MZ	48	20	32	7,6	Rodajas : 5,5 mm

CORTADOR DE TOMATES

Carro corredero sobre PEAD, elevado para eyección en un cubeta GN h65. Rodajas uniformes de tomates, cítricos (ex. CTX40) , kiwis... Gran producción: colectividades, comida rápida.

Acero inoxidable, HPDE y PP

3,5 kg/min. 1 pz. / 2,5 seg.

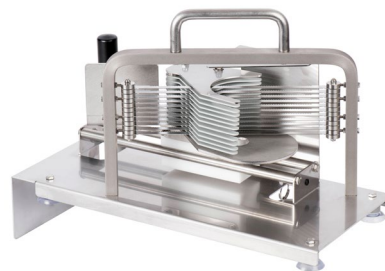

Réf.	↔	↗	⊥	📦	🔍
CTX	45,5	20	30	7,6	Rodajas : 5,5 mm
CTX40	48	20	27,5	8	Rodajas : 4 mm

CORTADOR DE TOMATES - COMPACT PRO

Rodajas uniformes de tomates: 5,5 mm. Pequeña restauración, pizzas, sándwiches.

Acero inoxidable, HPDE



Réf.	↔	↗	⊥	📦
CTXM55	30	15	17	2

CORTADOR DE TOMATES Y CÍTRICOS EN SECCIONES VERSIÓN BAJA

Corte rápido y regular de frutas y verduras sin piedras. Adaptado a los requerimientos de alta productividad de comunidades y comida rápida.

Acero inoxidable, ABS



Réf.	↔	↗	⊥	📦	🔍
CAX204	38,5	19	39	2,1	4 secciones
CAX206	38,5	19	39	2,1	6 secciones
CAX208	38,5	19	39	2,1	8 secciones
CAX212	38,5	19	39	2,1	12 secciones

CORTADOR DE TOMATES Y CÍTRICOS EN SECCIONES VERSIÓN ALTA

Corte rápido y regular de frutas y verduras sin piedras. Adaptado a los requerimientos de alta productividad de comunidades y comida rápida.

Acero inoxidable, ABS



Réf.	↔	↗	⊥	📦	🔍
CAX104	38,5	32,5	58	3	4 secciones
CAX106	38,5	32,5	58	3	6 secciones
CAX108	38,5	32,5	58	3	8 secciones
CAX112	38,5	32,5	58	3	12 secciones

RETIRADOR DE ENGANCHE PARA TOMATES

Ideal para retirar el enganche de los tomates antes de cortarlos con el corta tomates a rodajas.

Acero inoxidable



Réf.	↔	↗	⊥	📦
N3078	10,5	2	1	0,01

CORTA LECHUGA INOX

Ahorro de tiempo: corta una lechuga en 1 solo golpe. Fácil de limpiar. Perfecto para tiendas de bocadillos, kebabs, bares de ensaladas.

Seguridad: sistema de retención del empujador

Acero inoxidable, HDPE



Réf.					
CSA	39	30	120	19,5	Corte: 23 x 23 mm
CSAL	39	30	120	19,5	Tiras: 12 x 100 mm

CORTA LECHUGA COMPACTO

Corte : 25 x 25 mm.

Acero inoxidable, HDPE



Réf.				
CSAM	30	31	97	10,3

CUCHILLAS PARA CORTA LECHUGA

Bloque de cuchillas intercambiables con el mismo empujador CSAL02.

Acero inoxidable



Réf.			
CSA01	1,95	Cuchillo 23 x 23 mm	CSA / CSAL
CSAL01	2	Cuchillo 12 x 100 mm	CSAL

EMPUJADOR PARA CORTA LECHUGA

Robusto y duradero. Se desmonta fácilmente.

HDPE



Réf.						
CSA02	19	19	5	0,8	23 x 23 cm	CSA
CSAL02	19	19	5	0,9	12 x 100 mm	CSA / CSAL

BLOQUE DE CUCHILLAS PARA CSAM

Para un corte perfecto.

Acero inoxidable, HDPE



Réf.	
CSAM01	CSAM

EMPUJADOR PARA CSAM

Robusto y duradero. Se desmonta fácilmente.

Acero inoxidable, HDPE



Réf.	
CSAM02	CSAM



CORTADOR EN TIRAS



LOUIS TELLIER
BIEN NE REMPLACE LE FAIT MAINT



Made in France

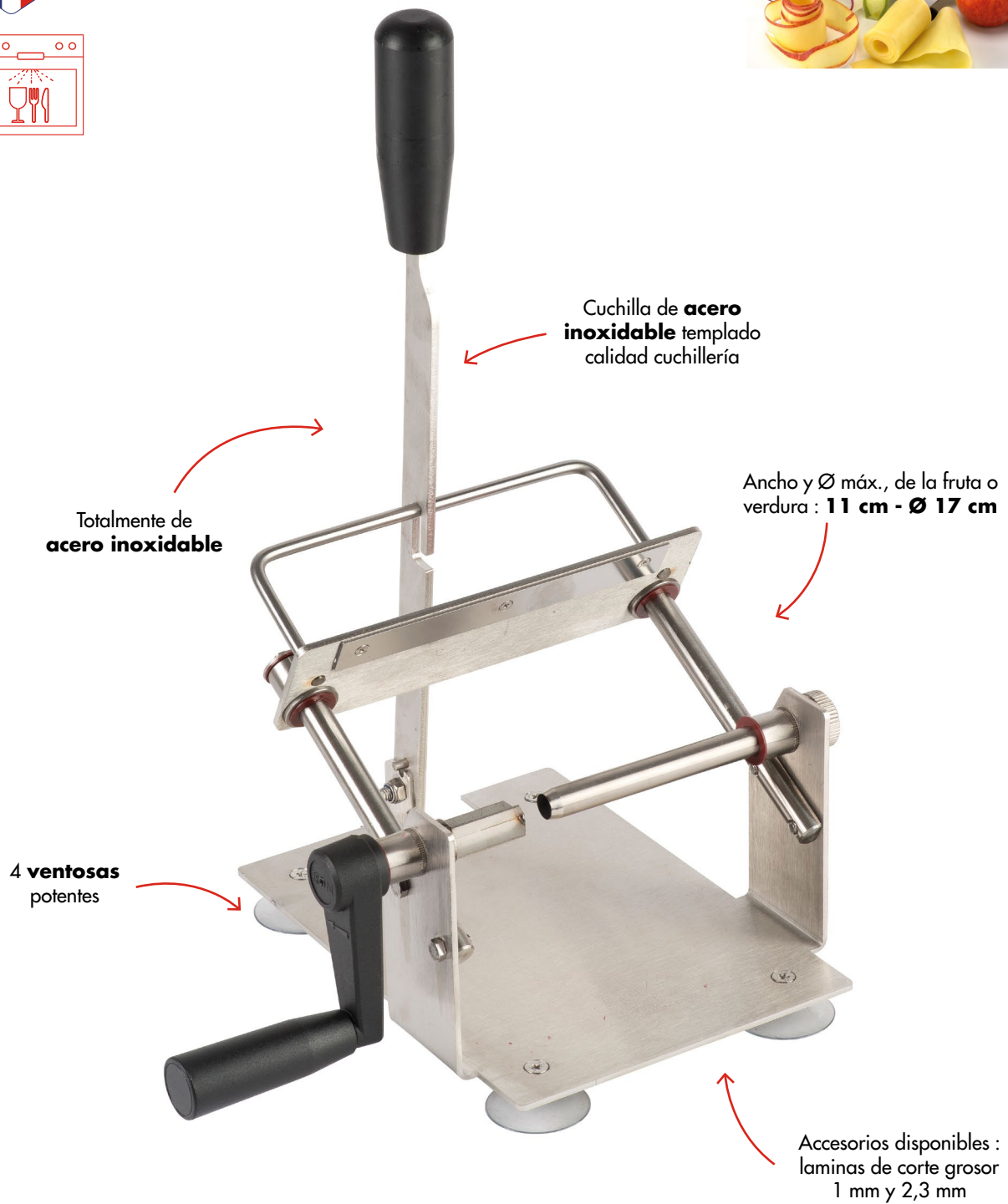

Para cortar verduras y frutas firmes y homogéneas en tiras anchas y finas.

Para reinterpretar las lasañas, los millojas, los rollitos de primavera, las terrinas de verduras, etc.

CORTADOR EN BASTONCILLOS PALANCA

Para bastoncillos y patatas fritas. Efecto de palanca para mayor eficiencia.

Acero inoxidable, HDPE, PP, ABS



Réf.					
CC08	35,5	26	66	4	8 x 8 mm
CC10	35,5	26	66	4	10 x 10 mm

EMPUJADOR

Robusto y duradero. Se desmonta fácilmente.

PP



Réf.		
CC208.	8 x 8 mm	FPN08 / FPN10 / CC08 / CC10
CC210.	10 x 10 mm	FPN08 / FPN10 / CC08 / CC10

CORTADOR EN TIRAS DE INOX. CON PALANCA

Cortador: 15 cm. Anchura y Ø max de las verduras-frutas: Max: 11 cm - Ø 17cm. Corte creativo, lamina las frutas y verduras en finas y amplias tiras: reinvente lasaña, rollos de primavera, terrinas, milhojas...

Acero inoxidable



Réf.					
CLANX	25	23	42	2	Con palanca

CORTADOR EN TIRAS DE INOX. SIN PALANCA

Cortador: 15 cm. Anchura y Ø max de las verduras-frutas: Max: 11 cm - Ø 17cm. Corte creativo, lamina las frutas y verduras en finas y amplias tiras: reinvente lasaña, rollos de primavera, terrinas, milhojas...

Acero inoxidable



Réf.					
CLANX-05	20	20	25	1,45	Sin palanca

CORTADOR DE VERDURAS JAPONÉS - 4 CUCHILLAS

Anchura max de las verduras-frutas: 13 cm. Corte creativo de frutas y verduras: tiras, cabello de ángel: reinvente lasaña, rollos de primavera, milhojas...

4 cuchillas : lasaña | 130 de 0,5 mm - cabello de ángel | 1 mm de 1,2 mm - filete de 1,2 mm - filete de pescado de 1,2 mm.

ABS, hojas de acero inoxidable



Réf.					
CLAN01	28	25	16,5	2,5	4 funciones

CORTADOR DE VERDURAS JAPONÉS - CUCHILLA REVERSIBLE

4 espesores posibles: 0,8 - 1 - 1,2 - 1,4 mm. Anchura y Ø maximum de la verdura o del fruto: 8 cm - Ø 10 cm. Corte creativo de frutas y verduras: tiras, cabello de ángel: reinvente lasaña, rollos de primavera, milhojas...

1 hoja reversible: lasaña y cabello de ángel

ABS, hojas de acero inoxidable



Réf.					
CLAN02	24	23	16	1,8	2 funciones 4 capas

CORTADOR EN TIRAS «LE ROUET GOURMET»



LOUIS TELLIER
BIEN NE REMPLACE LE FAIT MAINT



Made in France



Espaguetis y
cabellos de ángel



Julienas
y tagliatelles



ABS,
acero inoxidable

Material acero
inoxidable
robusto

Con 3 peines cortadores en
láminas : 1 mm, 2 mm y 4 mm

Corte **ajustable**
de 1 a 4 mm

Gran estabilidad gracias
a sus 4 **potentes**
ventosas

Cree tagliatelle, spaghetti y julianas de frutas y verduras girando unas pocas veces la manivela. Elaborará fácilmente coleslaw, rösti y patatas paillasson.

Adaptado a una gran variedad de frutas y verduras, incluso de carne firme, como las zanahorias, el apio, las cebollas, los calabacines, o las manzanas.

CORTADOR DE VERDURAS JAPONÉS - 2 CUCHILLAS

Anchura max de las verduras-frutas: 13 cm. Corte creativo de frutas y verduras: tiras, cabello de ángel: reinvente lasaña, rollos de primavera, milhojas...

☞ 2 cuchillas : lasaña 130 espesor 0,5 mm - cabello de ángel 1 mm espesor 1,2 mm

☞ ABS, hojas de acero inoxidable



Réf.	☞	☞	☞	☞	☞
CLAN03	28	25	16,5	1,54	2 funciones

CORTADOR DE VERDURAS JAPONÉS - 1 CUCHILLA

Anchura max de las verduras-frutas: 13 cm. Corte creativo de frutas y verduras: tiras, cabello de ángel: reinvente lasaña, rollos de primavera, milhojas...

☞ Cuchilla para lasaña 130 espesor 0,5mm

☞ ABS, hojas de acero inoxidable

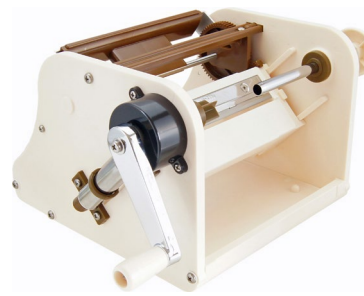

Réf.	☞	☞	☞	☞	☞
CLAN04	28	25	16,5	1,98	1 función

CORTADOR DE VERDURAS «LE ROUET»

Espesor de corte: 0,8 mm. Estable y robusto. Producción rápida de guirnalda, espaguetis, y tagliatelas de frutas y verduras.

☞ Cuchilla (guirnalda) y 3 peines de aclareo: 2 mm - 3 mm y 6 mm

☞ Acero inoxidable, aluminio fundido

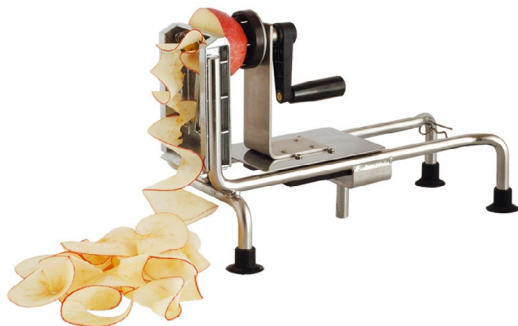

LT
LOUIS TELLIER

Réf.	☞	☞	☞	☞
4030CLR	37	14	25	3

CORTADOR DE VERDURAS «LE ROUET GOURMET»

Espesor de corte regulable: 1-4 mm. Amplia variedad de dimensiones de cabello de ángel, espaguetis y tagliatelas de frutas y verduras.

☞ Cuchilla regulable (guirnalda) y 3 peines de aclareo: 1 mm, 2 mm, 4 mm. 4 potentes ventosas.

☞ ABS, acero inoxidable, aluminio fundido



LT
LOUIS TELLIER

Réf.	☞	☞	☞	☞
4100CLR	36	13	25	2,21

MÁQUINA TALLADORA DE HORTALIZAS

☞ Acero inoxidable, HDPE



LT
LOUIS TELLIER

Réf.	☞	☞	☞	☞	☞
MLT.	31	17	26	3,2	Aparato completo
MLT01.				0,01	Cuchilla de repuesto sola
					MLT

CORTADORA JAPONESA DE VERDURA EN ESPIRAL

Espesor de corte: 0,8 mm. Corte perfecto y muy fino: cabello de ángel, espaguetis, tagliatelas.

☞ Cuchilla lisa (guirnalda) y 3 peines de aclareo: 1 mm - 2,5 mm y 4 mm

☞ ABS, hojas de acero inoxidable

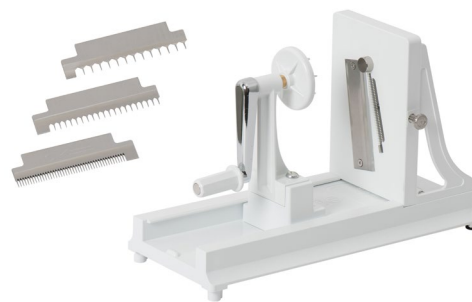

ASHI
BAMBER
The Legend of
JAPAN

Réf.	☞	☞	☞	☞
4500CLR	27	12	17,5	0,53

KIT MULTICORTE DE INOX

ALLIGATOR
FAMILY



Con **3** cuchillas :
3 x 3 - 6 x 6 y 9 x 9 mm

Para **cortar en láminas** cebollas,
cortar las patatas fritas y **picar** el ajo



Acero inoxidable

Recipiente **recuperador**

En 2001, el inventor Benny Engdah creó el Alligator, con la intención de facilitar la preparación de su plato sueco favorito : las Kroppkakor, bolitas de patatas rellenas de cebolla laminada y bacon. Registró una patente y muy rápidamente el éxito fue mundial : la facilidad de utilización de este cortador de verduras revolucionario conquistó a los cocineros profesionales y a los particulares. Pierre Tellier, como fabricante de aparatos profesionales de corte de frutas y verduras se sintió naturalmente seducido por este pequeño aparato, eficaz y poco voluminoso, e introdujo el Alligator en Francia en 2005.

El cortador de verduras Alligator se distingue por su robustez, la calidad de sus cuchillas y sus rejillas.

PICADORA ALLIGATOR ORIGINAL

cuchillo: 6 x 6 mm. Cebolla en rodajas en un gesto.

ABS, hojas de acero inoxidable



Ref.				
N3011	28	11	4	0,38

CUCHILLA ALLIGATOR ORIGINAL 12 X 12 MM

Para cortar cubos / papas fritas.

ABS, hojas de acero inoxidable



Ref.					
N3011-C	28	11	4	0,21	N3011 / N3011R

CORTADOR ALLIGATOR ORIGINAL CON RECEPTACULO

cuchillo: 6 x 6 mm. Cebolla en rodajas en un gesto.

Bandeja colectora

ABS, hojas de acero inoxidable



Ref.				
N3011R	28	11	10	0,48

LOTE DE 3 CORTADORES ALLIGATOR ORIGINAL

Corta cebollas N3011R + cuchillo N3011-C + mini COCODRILO N3011M

ABS, hojas de acero inoxidable



Ref.	
N3011S	0,88

CORTADOR DE CEBOLLA ORIGINAL

Rodaja: 5,5 mm. Para cebollas y tomates.

ABS, hojas de acero inoxidable



Ref.				
N3011T	28	11,5	6	0,9

LOTE DE 3 CORTADORES ALLIGATOR MULTIUSOS

3 cuchillos: 3 x 3-6 x 6-12 x 12 mm. Para picar las cebollas, corta las papatas fritas y pica el ajo. Con bandeja de goteo.

3 cuchillos : 3x3 - 6x6 - 12x12 mm

Acero inoxidable



Ref.				
AL21P001	28	11	10	0,985

RECEPTÁCULO

Tritan

ALLIGATOR
of Occident

Réf.	↔	↗	⌋	📦	🔗
N3011-B	12,5	9,5	7	0,12	N3011R
N3011-BX	12,5	9	7	0,09	N3011X

KIT CUCHILLOS + EMPUJADORES

Limpieza al lavavajillas

Con rejilla de limpieza

PP, hojas de acero inoxidable

ALLIGATOR
of Occident

Réf.	↔	↗	⌋	📦	🔍	🔗
N3011X-09K	12,2	10	2	0,3	9 mm	N3011X
N3011X-K	12,2	10	2	0,3	3 + 6 + 12 mm	N3011X

CUCHILLO

Limpieza al lavavajillas.

PP, hojas de acero inoxidable

ALLIGATOR
of Occident

Réf.	↔	↗	⌋	📦	🔍	🔗
N3011X-03	12	10	0,8	0,6	3 mm	N3011X
N3011X-06	12	10	0,8	0,6	6 mm	N3011X
N3011X-12	12	10	0,8	0,6	12 mm	N3011X

CUCHILLA TRINCHANTE BASCULANTE

Para cincelar 2 a 3 veces más rápido hierbas, ajo, cebollas, chalotas.

Hojas de acero inoxidable templado, mangos de ABS

LOUIS TELLIER

Réf.	↔	↗	⌋	📦	🔍
N3236	22	5,3	14,2	1	3 cuchillas de 300 mm

PRENSADOR DE AJO - PRODUCTIVIDAD

Construcción robusta. Empujador con picos atrapando la membrana: limpieza fácil. Exprimir hasta 5 dientes de ajo seguidos. Recolectar la pulpa con un golpe de pulgar sobre la lengüeta. Sin pérdida.

Lengua «pala».

Zinc cromado y nylon

BEST SELLER

LOUIS TELLIER

Réf.	↔	↗	⌋	📦
N4298	17,5	3,5	6	0,38



ALLIGATOR®

PELADOR PARA GRANDES COCINAS



LOUIS TELLIER
BIEN NE REMPLACE LE FAIT MAIN



Made in
France

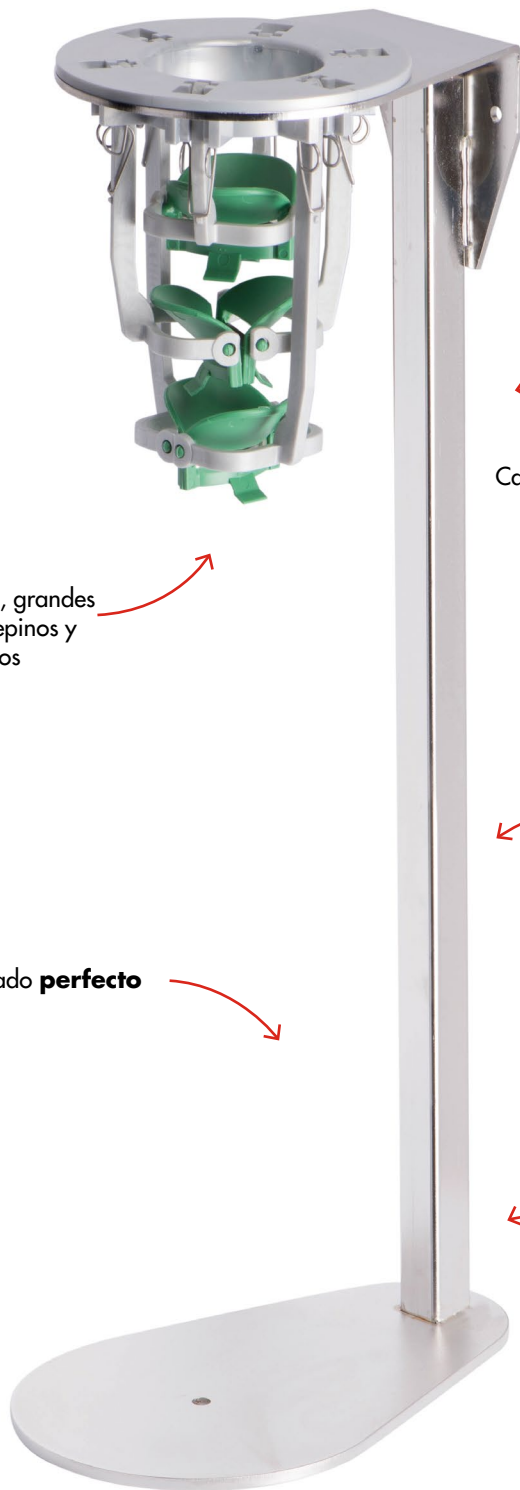

Para zanahorias, grandes
zanahorias, pepinos y
espárragos

Cabezas **intercambiables**

Sencillo y rápido

Pelado **perfecto**

Ninguna pérdida :
mondaduras finas

Nuestros peladores le seducirán por sus numerosas cualidades :

- Ahorro de tiempo : 100 kg de zanahorias o 600 pepinos por hora
- Fácil de utilizar : introducir las verduras por arriba y después tirar hacia a bajo
- Sin pérdidas : las mondaduras son muy finas
- Fácil de limpiar

Varios modelos (sobre soporte, para fijar...) disponibles para zanahorias (pequeñas y grandes), pepinos y espárragos.

PELADOR MURAL INOX. - ZANAHORIAS

Permite un pelado de alto rendimiento. Fácil de usar. Sin pérdidas gracias a los peelings finos.

Cuerpo, hojas y base de acero inoxidable, PA



LOUIS TELLIER



Réf.					
EMX001	12,5	17	24	0,76	Ø introducción : 4,5 cm

PELADOR MURAL INOX. - ZANAHORIAS GRANDES

Permite un pelado de alto rendimiento. Fácil de usar. Sin pérdidas gracias a los peelings finos.

Cuerpo, hojas y base de acero inoxidable, PA



LOUIS TELLIER



Réf.					
EMX002	12,5	17	24	0,76	Ø introducción : 6 cm

PELADOR MURAL INOX. - PEPINOS

Permite un pelado de alto rendimiento. Fácil de usar. Sin pérdidas gracias a los peelings finos.

Cuerpo, hojas y base de acero inoxidable, PA



LOUIS TELLIER



Réf.					
EMX003	12,5	25	25,5	0,76	Ø introducción : 6 cm

PELADOR MURAL INOX. - ESPÁRRAGOS

Permite un pelado de alto rendimiento. Fácil de usar. Sin pérdidas gracias a los peelings finos.

Cuerpo, hojas y base de acero inoxidable, PA



LOUIS TELLIER



Réf.					
EMX004	12,5	17	24	0,76	Ø introducción : 4,5 cm

PELADOR MURAL EPOXY - ZANAHORIAS

Permite un pelado de alto rendimiento. Fácil de usar. Sin pérdidas gracias a los peelings finos.

Base de acero, epoxy, PA, hojas de acero inoxidable



LOUIS TELLIER



Réf.					
EM001.	12,5	17	24	0,5	Ø introducción : 4,5 cm

PELADOR MURAL EPOXY - ZANAHORIAS GRANDES

Permite un pelado de alto rendimiento. Fácil de usar. Sin pérdidas gracias a los peelings finos.

Base de acero, epoxy, PA, hojas de acero inoxidable



LOUIS TELLIER



Réf.					
EM002.	12,5	17	24	0,5	Ø introducción : 6 cm

PELADOR MURAL EPOXY - PEPINOS

Permite un pelado de alto rendimiento. Fácil de usar. Sin pérdidas gracias a los peelings finos.

Base de acero, epoxy, PA, hojas de acero inoxidable



Réf.					
EM003.	12,5	17	24	0,5	∅ introducción : 6 cm

PELADOR MURAL INOX - ESPÁRRAGOS

Permite un pelado de alto rendimiento. Fácil de usar. Sin pérdidas gracias a los peelings finos.

Base de acero, epoxy, PA, hojas de acero inoxidable



Réf.					
EM004	12	17	24	0,5	∅ introducción : 4,5 cm

PELADOR SOBRE PIE INOX. - ZANAHORIAS

Permite un pelado de alto rendimiento. Fácil de usar. Sin pérdidas gracias a los peelings finos.

Cuerpo, hojas y base de acero inoxidable, PA



Réf.					
EPX001.	21,5	14	51	1,8	∅ introducción : 4,5 cm

PELADOR SOBRE PIE INOX. - ZANAHORIAS GRANDES

Permite un pelado de alto rendimiento. Fácil de usar. Sin pérdidas gracias a los peelings finos.

Cuerpo, hojas y base de acero inoxidable, PA



Réf.					
EPX002.	21,5	14	51	1,8	∅ introducción : 6 cm

PELADOR SOBRE PIE INOX. - PEPINOS

Permite un pelado de alto rendimiento. Fácil de usar. Sin pérdidas gracias a los peelings finos.

Cuerpo, hojas y base de acero inoxidable, PA



Réf.					
EPX003.	21,5	14	51	1,8	∅ introducción : 6 cm

PELADOR SOBRE PIE INOX. - ESPÁRRAGOS

Permite un pelado de alto rendimiento. Fácil de usar. Sin pérdidas gracias a los peelings finos.

Cuerpo, hojas y base de acero inoxidable, PA



Réf.					
EPX004	21,5	14	51	1,8	∅ introducción : 4,5 cm



PELADOR SOBRE PIE EPOXY - ZANAHORIAS

Permite un pelado de alto rendimiento. Fácil de usar. Sin pérdidas gracias a los peelings finos.

Base de acero pintado con epoxi, PA, hojas de acero inoxidable



LOUIS TELLIER



Ref.					
EPO01.	21,5	14	51	1,8	Ø introducción : 4,5 cm

PELADOR SOBRE PIE EPOXY - ZANAHORIAS GRANDES

Permite un pelado de alto rendimiento. Fácil de usar. Sin pérdidas gracias a los peelings finos.

Base de acero pintado con epoxi, PA, hojas de acero inoxidable



LOUIS TELLIER

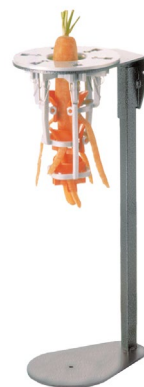

Ref.					
EP002.	21,5	14	51	1,8	Ø introducción : 6 cm

PELADOR SOBRE PIE EPOXY - PEPINOS

Permite un pelado de alto rendimiento. Fácil de usar. Sin pérdidas gracias a los peelings finos.

Base de acero pintado con epoxi, PA, hojas de acero inoxidable



LOUIS TELLIER



Ref.					
EP003.	21,5	14	51	1,8	Ø introducción : 6 cm

PELADOR SOBRE PIE EPOXY - ESPÁRRAGOS

Permite un pelado de alto rendimiento. Fácil de usar. Sin pérdidas gracias a los peelings finos.

Base de acero pintado con epoxi, PA, hojas de acero inoxidable



LOUIS TELLIER



Ref.					
EP004.	21,5	14	51	1,8	Ø introducción : 4,5 cm

PELADOR CON SOPORTE BRIDA - ZANAHORIAS

Permite un pelado de alto rendimiento. Fácil de usar. Sin pérdidas gracias a los peelings finos.

Cuerpo, hojas y base de acero inoxidable, PA



LOUIS TELLIER

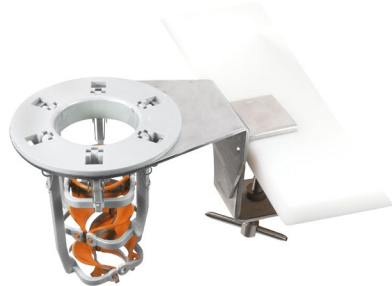

Ref.					
ESJX001	22	12,6	10	1,25	Ø introducción : 4,5 cm

PELADOR CON SOPORTE BRIDA - ZANAHORIAS GRANDES

Permite un pelado de alto rendimiento. Fácil de usar. Sin pérdidas gracias a los peelings finos.

Cuerpo, hojas y base de acero inoxidable, PA



LOUIS TELLIER

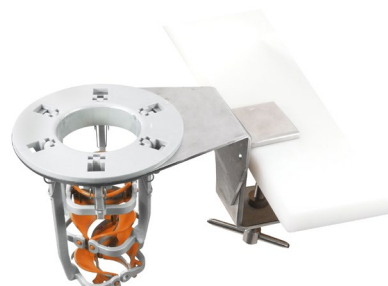

Ref.					
ESJX002	22	12,6	10	1,25	Ø introducción : 6 cm

PELADOR CON SOPORTE BRIDA - PEPINOS

Permite un pelado de alto rendimiento. Fácil de usar. Sin pérdidas gracias a los peelings finos.

Cuerpo, hojas y base de acero inoxidable, PA



LOUIS TELLIER

Réf.					
ESJX003	22	12,6	10	1,25	Ø introducción : 6 cm

PELADOR CON SOPORTE BRIDA - ESPARRAGOS

Permite un pelado de alto rendimiento. Fácil de usar. Sin pérdidas gracias a los peelings finos.

Cuerpo, hojas y base de acero inoxidable, PA



LOUIS TELLIER

Réf.					
ESJX004	22	12,6	10	1,25	Ø introducción : 4,5 cm

CABEZAS - ZANAHORIAS

Cabezas intercambiables. Piezas de recambio (ressortes, hojas, brazos, placa) disponibles.

Con empujador

Poliamida reforzada, acero inoxidable



LOUIS TELLIER

Réf.					
E0010.	4,5	22	0,16	Cabeza para zanahorias	EM / EP / EPX / ESJX

CABEZAS - ZANAHORIAS GRANDES

Cabezas intercambiables. Piezas de recambio (ressortes, hojas, brazos, placa) disponibles.

Con empujador

Poliamida reforzada, acero inoxidable



LOUIS TELLIER

Réf.					
E0011.	6	20	0,28	Cabeza para zanahorias grandes	EM / EP / EPX / ESJX

CABEZAS - PEPINOS

Cabezas intercambiables. Piezas de recambio (ressortes, hojas, brazos, placa) disponibles.

Poliamida reforzada, acero inoxidable



LOUIS TELLIER

Réf.					
E0012.	6	16	0,15	Cabeza pepinos	EM / EP / EPX / ESJX

CABEZAS - ESPARRAGOS

Cabezas intercambiables. Piezas de recambio (ressortes, hojas, brazos, placa) disponibles.

Poliamida reforzada, acero inoxidable



LOUIS TELLIER

Réf.					
E0019.	4,5	15,5	0,14	Cabeza espárragos	EM / EP / EPX / ESJX

PELADOR DE SANDÍA Y CALABAZA

Anchura útil: 6,5 cm. Espesor de corta regulable.

Hojas de acero inoxidable, ABS



Réf.				
ID4006	17	10,5	3,5	0,25

PELADOR PARA VERDURAS GRANDES

Anchura útil: 8 cm. Mangos, sandías, calabazas.

Acero inoxidable



Réf.				
ID4007	20	10	1,5	0,1

PELADOR DE ESPÁRRAGOS

Práctico sistema en pinza.

Acero inoxidable



Réf.				
N3079	17,5	4	1,5	0,4

PELADOR ELÉCTRICO PROFESIONAL

Para pelar cítricos, cebollas y todas frutas y verduras redondas y ovals en cantidad. Espesor de peladura ajustable. Particularidad cítricos: 1 paso de ida: quita solo la cáscara, o 2 pasos ida y vuelta: quita la cáscara y la piel blanca. Estanqueidad de los mandos.

Tridente, pico y cuchillo de acero inoxidable

3 - 4 pzs / min.

50 Hz - 24 W - 220 V



Réf.					
N4220	27	17	23,5	1,8	Moldelo profesional

PELADOR ELÉCTRICO SEMIPROFESIONAL

Para pelar cítricos, cebollas y todas frutas y verduras redondas y ovals en cantidad. Espesor de peladura ajustable. Particularidad cítricos: 1 paso de ida: quita solo la cáscara, o 2 pasos ida y vuelta: quita la cáscara y la piel blanca.

Tridente y pico de plástico, cuchillo de acero inoxidable

3 - 4 pzs / min.

50 Hz - 24 W - 220 V



Réf.					
N4221	26	16	23	1,8	Moldelo semi profesional

PELADOR MANUAL DE CÍTRICOS

Para retirar integralmente la cáscara de naranjas y limones.

Base de acero pintado con epoxi



Réf.					
N4225	29	5	14	0,65	Con fijación brida

PELADOR CASTOR

Doble hoja móvil de 4 cm útiles. Peladura fina. Sigue las curvas de las frutas y verduras.

Quitaojos de patata

Mango de acero inoxidable



Réf.				
N8012	11	6	1	0,03

PELADOR JULIANA - CASTOR

Doble hoja móvil con dientes enderezadas. Para tallar en finas julianas.

Mango y hojas de acero inoxidable



Réf.				
N8013	11	6,2	1,2	0,03

PELADOR PIEL FINA - POLLUX

Doble hoja móvil microdentada. Pela todas las cáscaras, incluso finas o peludas: tomates, berenjenas, pimientos, melocotones, kiwis.

Quitaojos de patata

Cuerpo y hojas de acero inoxidable, mango de PP



Réf.				
N8014	17,3	2	1,5	0,03

PELADOR POLLUX

Doble hoja móvil de 4 cm útiles. Peladura fina. Sigue las curvas de las frutas y verduras.

Quitaojos de patata

Hoja de acero al carbono templado, mango de PP, cuerpo de acero inoxidable



Réf.				
N8015	17,4	2	1,5	0,03

PELADOR ELÉCTRICO



Este utensilio profesional permite pelar grandes cantidades de cítricos, cebollas y todo tipo de frutas y verduras redondas y ovaladas.

Diferencia entre los dos modelos : el tridente y el pico centrador son de acero inoxidable en el modelo profesional y de plástico en el modelo semi-profesional.

CORTADOR EN SECCIONES



Réf. CAX104,106,108, 112



Réf. CAX104P, 106P, 108P



Eficacia :
el centrado del fruto
proporciona un corte **regular**

Cuchillas y empujadores
intercambiables

Higiene :
fabricación de acero inoxidable y
materiales compuestos **resistentes** a
los agentes con lejía, lo que
le hace apto para el lavavajillas

Separación de las patas
que permite la **utilización**
de un recipiente de
recuperación 1/2 gastro

Corte en 4, 6, 8 o 12
secciones según desee
de todas las frutas y
verduras sin hueso

Seguridad :
ningún contacto con las
cuchillas. Buena sujeción en la
encimera por medio de
3 ventosas

Este cortador de tomates y cítricos en secciones versión alta está adaptado a las exigencias de las grandes producciones como las colectividades y los restaurantes de comida rápida. Corte en secciones tomates, cítricos, kiwis...

Accesorio cuchillo vaciador disponible.

CORTADOR DE 1/2 O 1/4 DE RODAJAS DE LIMÓN

¼ de rodaja (corte 6 mm) : Mojito, Caïpirinha y Ti-punch preparados 3 veces más rápido.

½ rodaja (corte 12 mm) : para mariscos, pescado, cócteles.

CDX40

Acero inoxidable, ABS, HDPE



LOUIS TELLIER NF NSF



Réf.	↔	↗	⊥	📦	🔍	📎
CDX4	39	19	40	2,1	Corte: 12 mm	
CDX7	39	19	40	2,1	Corte: 6 mm	
CDX47	39	19	40	4,5	Corte: 6 + 12 mm	

CUCHILLO CORTADOR CON ASAS - CORTADOR DE LIMÓN

¼ de rodaja (corte 6 mm) : Mojito, Caïpirinha y Ti-punch preparados 3 veces más rápido.

½ rodaja (corte 12 mm) : para mariscos, pescado, cócteles.

Acero inoxidable, ABS, HDPE



LOUIS TELLIER



Réf.	📦	🔍	📎
CDX40	0,42	Cuchillo cortador de 12 mm con asas	CDX
CDX70	0,42	Cuchillo cortador de 6 mm con asas	CDX

CORTADOR Y DESCORAZONADOR DE MANZANAS

Corta a secciones y descorazona las manzanas.

Acero inoxidable, ABS



LOUIS TELLIER NF NSF



Réf.	↔	↗	⊥	📦	🔍
CAX104P	38,5	32,5	58	3	4 secciones
CAX106P	38,5	32,5	58	3	6 secciones
CAX108P	38,5	32,5	58	3	8 secciones

CUCHILLAS PARA CORTADOR Y DESCORAZONADOR DE MANZANAS

Cuchillas Intercambiables para CAX a secciones o para manzanas, versión alta o baja. Atención: utilizar sólo con el empujador adaptado: 4-8 o 6-12

Acero inoxidable



LOUIS TELLIER



Réf.	📦	🔍	📎
CAX004	0,2	4 secciones	CAX
CAX006	0,2	6 secciones	CAX
CAX008	0,2	8 secciones	CAX
CAX012	0,2	12 secciones	CAX

CUCHILLO PARA CORTADOR Y DESCORAZONADOR DE MANZANA

Cuchillas Intercambiables para CAX a secciones o para manzanas, versión alta o baja. Atención: utilizar sólo con el empujador adaptado: 4-8 o 6-12

Acero inoxidable



LOUIS TELLIER



Réf.	📦	🔍
CAX004P	0,09	4 secciones
CAX006P	0,2	6 secciones
CAX008P	0,2	8 secciones

EMPUJADOR PARA CORTADOR A GAJOS

Robusto y duradero. Se desmonta fácilmente.

Acero inoxidable, ABS



LOUIS TELLIER



Réf.	↔	↗	⊥	📦	🔍	📎
CAX015	38	18	20	0,4	4 - 8 secciones	CAX104 / CAX108 / CAX204 / CAX208 / CAX104P / CAX108P
CAX016	38	18	20	0,57	6 - 12 gajos	CAX106 / CAX112 / CAX206 / CAX212 / CAX106P

PELADOR DE MANZANAS PROFESIONAL KALI

Rodaja: 4 mm. Pela, corta a rojadas y saca el corazón de las manzanas.

- Fijación de abrazadera
- Hojas de acero inoxidable, base de acero fundido pintado con epoxi

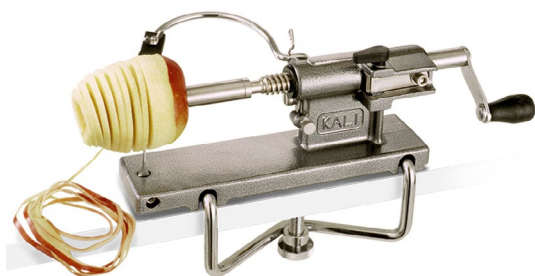
LOUIS TELLIER

Réf.	↔	↗	⊥	📦	🔍
N4230	32	12,5	21	1,5	Manual

CORTADOR DE MANZANAS

Descorazona y corta a secciones en un solo gesto

- Acero inoxidable

LOUIS TELLIER

Réf.	⊙	↔	↗	⊥	📦	🔍
N4206	●	9	2,5	0,1		8 secciones
N4207		9	2,5	0,1		10 secciones

PELADOR DE MANZANAS DOMÉSTICO

Para pelar y quitar el hueso sin cortar.

- Con accesorio sin rebanar
- Hojas de acero inoxidable, cuerpo de acero fundido pintado con epoxi



Réf.	↔	↗	⊥	📦	🔍
N4231	41	12	18,5	0,62	Sin cortar

PELADOR DE MANZANAS DOMÉSTICO - VENTOSA

Rodaja : 4 mm. Pela, corta a rojadas y saca el corazón de las manzanas. Modelo original.

- Hojas de acero inoxidable, cuerpo de acero fundido pintado con epoxi

LOUIS TELLIER

Réf.	↔	↗	⊥	📦	🔍
N4232T	23	10	14	0,9	Fijación ventosa

PELADOR DE MANZANAS CON FIJACIÓN BRIDA

Rodaja : 4 mm. Pela, corta a rojadas y saca el corazón de las manzanas. Modelo original.

- Hojas de acero inoxidable, cuerpo de acero fundido pintado con epoxi

LOUIS TELLIER

Réf.	⊙	↔	↗	⊥	📦	🔍
N4233	●	32	4	20	0,79	Fijación brida

PINZA PARA DESHUESADORA DE CEREZAS

- Aluminio



Réf.	↔	↗	⊥	📦
N4185	19,3	4,5	2,5	0,17

PELADOR Y CORTADOR DE MANZANAS PROFESIONAL KALI - MANUAL



LOUIS TELLIER

SEEN NE REMPLACE LE FATI MARK



Cuchilla de acero inoxidable y soporte de fundición de acero para un uso duradero y una solidez a toda prueba

Empuñadura **ergonómica**

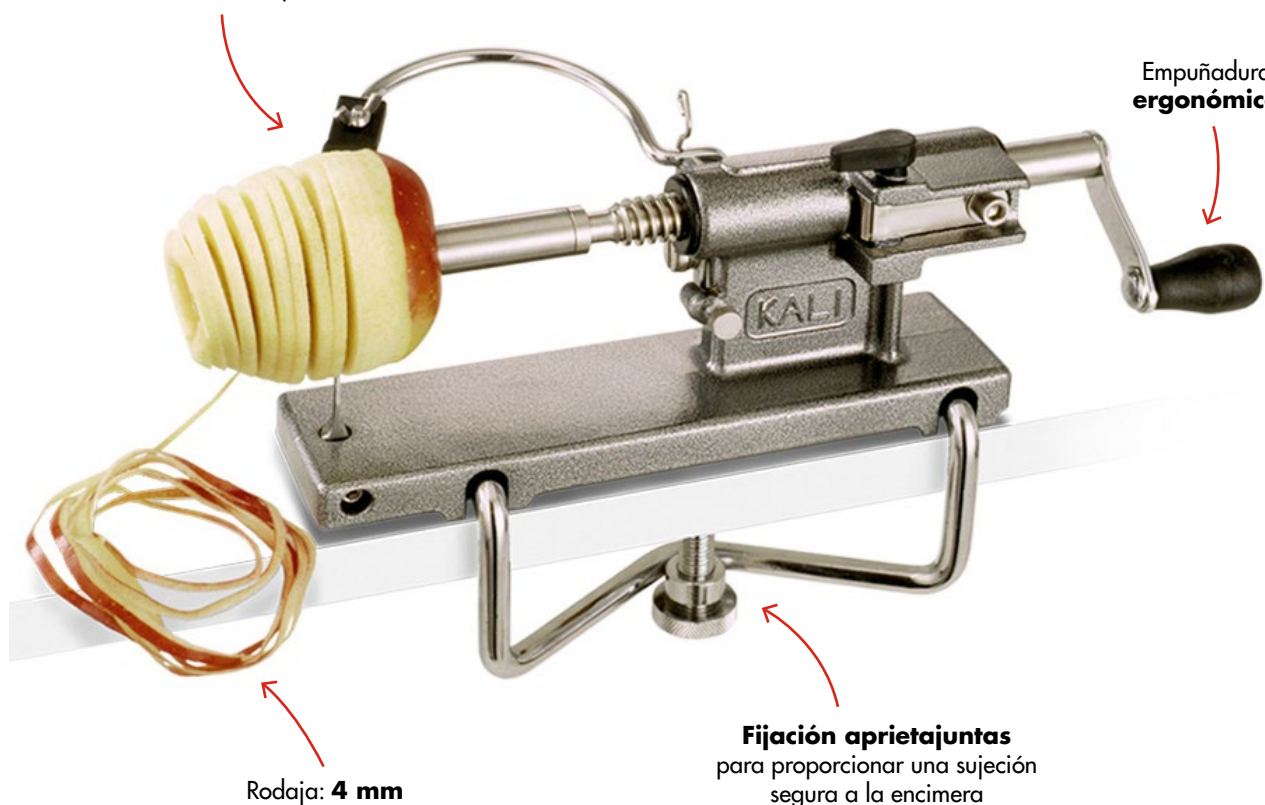

Rodaja: **4 mm**

Fijación aprietajuntas para proporcionar una sujeción segura a la encimera

Gracias a su alto rendimiento de hasta 40 kg de manzanas por hora, este pelador de manzanas se adapta a las exigencias de la producción a gran escala, como la restauración colectiva y la restauración.

PELADOR Y CORTADOR DE PIÑAS



LOUIS TELLIER
BIEN NE REMPLACE LE FAIT MAIN

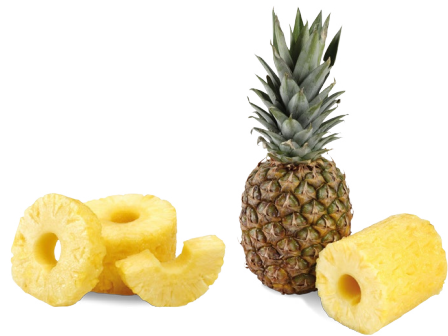

Pela y vacía
la piña con un solo
movimiento

Posibilidad de colocar
un recipiente de recuperación
de **tipo GN 1/1** de 15 cm
debajo del aparato

Seguridad total :
sistema que impide la caída
inesperada del empujador
y fijación en la encimera
asegurada
por **4 ventosas**

Fabricación de acero
inoxidable 18/10.
Cuchilla y empujador
desmontables sin
herramientas para
limpieza después de
cada utilización

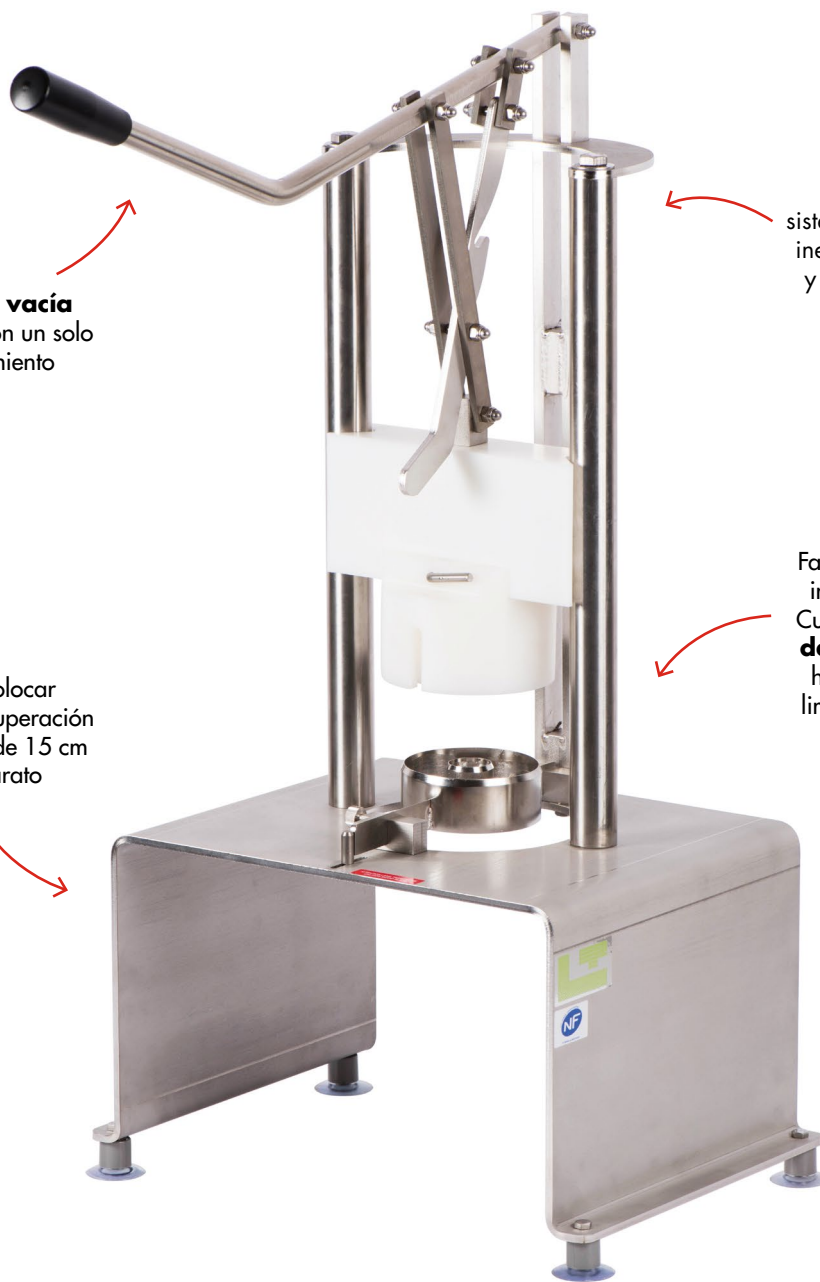

Este cortador de piña pela y vacía en un solo movimiento. Está adaptado a las exigencias de las grandes producciones como las colectividades y la restauración.

6 accesorios disponibles.

PELADOR DE PIÑAS

Pela y saca el corazón de la piña en un mismo movimiento. Sistema de seguridad. Utilización sin esfuerzo físico. Cuchillo y empujador desmontables sin herramienta.

Acero inoxidable, HDPE



Réf.					
EA.	45	39	72	18	Ø 89 mm
EA095	45	39	72	18	Ø 95 mm
EA102	45	39	72	18	Ø 102 mm

PELADOR DE PIÑAS ELÉCTRICO

Tiempo de trabajo constante y continuo. Sistema seguro (comando de acción con ambas manos). Impermeable IP66. Fuente de alimentación 100/240V. Frecuencia 50/60 Hz. Alimentación 29V / 45A.

Acero inoxidable



Réf.				
EA-EL	45	35	103	18,5

CUCHILLA PARA PELADOR DE PIÑAS

Acero inoxidable



Réf.			
EA003	0,23	Ø 74 mm	EA/EA-EL
EA001	0,45	Ø 89 mm	EA/EA-EL
EA007	0,33	Ø 95 mm	EA/EA-EL
EA005	0,33	Ø 102 mm	EA/EA-EL

CUCHILLA PARA PELADOR DE PIÑAS 8 SECCIONES

Acero inoxidable



Réf.		
EA013	8 secciones	EA/EA-EL

CUCHILLA PARA PELADOR DE MANGO

Acero inoxidable



Réf.			
EA009	0,15	Mango	EA

EMPUJADOR PARA PELADOR DE PIÑAS

Robusto y duradero.

HDPE



Réf.			
EA004	0,37	Ø 74 mm	EA/EA-EL
EA002	0,48	Ø 89 mm	EA/EA-EL
EA008	0,55	Ø 95 mm	EA/EA-EL
EA006	0,59	Ø 102 mm	EA/EA-EL

EMPUJADOR PARA PELADOR DE PIÑAS 8 SECCIONES

Robusto y duradero.

HDPE

LOUIS TELLIER

Réf.		
EA014	8 secciones	EA

EMPUJADOR PARA PELADOR DE MANGO

Robusto y duradero.

HDPE

LOUIS TELLIER

Réf.			
EA010	0,52	Mango	EA

DESCORAZÓNADOR DE PIÑA

Un corte del corazón fácil, limpio y rápido. Aptas para el lavavajillas.

Acero inoxidable

LOUIS TELLIER

Réf.			
N4200	2,8	3	0,1

CORTA PIÑAS

Distancia de hojas ajustable de 90 a 150 mm. Corta las dos puntas de la piña en un solo movimiento

2 palas curvas, cuna

Acero inoxidable, HDPE



Réf.				
N4210	33	22	20	5

GUIA DE CORTE

Espesor de corte : 1 cm.

Acero inoxidable, HDPE



Réf.				
TR10	25,5	14	17	2,1

CORTADOR DE COCO

Sin esfuerzo. Poner el coco en el recipiente de inox debajo de la prensa y accionar el gato. Ideal para cortes frescos.

Acero inoxidable

4-5 pz / min.

LOUIS TELLIER

Réf.				
N4212	13	38	19	11,8

CORTA SANDÍAS

Para cortar las sandías en secciones regulares, así como melones redondos u ovals. Sobre un plano de trabajo bajo, cortar la parte superior de la sandía o melón, colocar el soporte sobre una mesa baja y la sandía encima, luego pinchar con la cuchilla superior y apretar firmemente hacia abajo.

Acero inoxidable



LOUIS TELLIER

Réf.					
SMPO4	37	28	19,5	2	4 secciones
SMPO6	35	28	24	2	6 secciones
SMPO8	37	28	19,5	2	8 secciones

SECCIONADOR DE SANDÍAS

Para cortar en regular cuarto sandías, melones redondos y ovals. Sobre un plano de trabajo bajo, cortar la parte superior de la sandía o melón, colocar el soporte sobre una mesa baja y la sandía encima, luego pinchar con la cuchilla superior y apretar firmemente hacia abajo.

Acero inoxidable



LOUIS TELLIER

Réf.					
N4215	50	60	40	7,5	4 partes. Bajo demanda.
N4214	50	60	40	9	6 partes. Bajo demanda.

SECCIONADOR DE MELÓN

Para cortar rápidamente en gajos regulares melones redondos y ovals. Columnas guías.

SM006, SM008, 1 soporte compatible con 6 y 8 tramos

Acero inoxidable, HDPE



LOUIS TELLIER

Réf.					
SM01	27	20	42	2,7	6 & 8 secciones
SM06	27	20	42	2,7	6 secciones
SM08	27	20	42	2,7	8 secciones

CUCHILLA PARA SECCIONADOR DE MELÓN

Cuchillas intercambiables con el mismo soporte.

Acero inoxidable



LOUIS TELLIER

Réf.						
SM006	27	20	7,5	0,5	6 secciones	SM01 / SM06 / SM08
SM008	27	20	7,5	0,6	8 secciones	SM01 / SM06 / SM08

TURN'UP® SACABOCADOS



LOUIS TELLIER
NEUF NE REMPLACE LE TAT WAIN



Para **degustar** crudos,
cocidos, fritos

Para **guarnecer** con cubitos, tártaros,
picado, queso, ensaladas, etc.



3 modelos :
grande/ pequeño/ coctel*

Cuerpo de plástico, cuchillas de
acero inoxidable desmontables
y utilizables individualmente como
molde de corte

Cortadores para fondos para rellenar a partir de patatas, calabacines, melones, pepinos, zanahorias grandes, nabos (previamente escaldados), etc.

*El turn'up cocktail consta de un molde de corte y un cuchillo de corte del fondo.

CORTADOR-ESTRELLAS

Tallaras frutas y verduras en 1 solo gesto con sus 5 cuchillas de acero! Ideal para huevos, tomates y kiwi. Conveniente para limpiar, completamente extraíble / lavavajillas.

Acero inoxidable, Tritan y ABS



Réf.			
CTE00	15	4	0,23

5 CUCHILLAS PARA CORTADOR-ESTRELLAS CTE00

Acero inoxidable y ABS



Réf.					
CTE01	4	3,5	2,7	0,02	5 cuchillas para Cortador-Estrellas CTE00

PLUMA-CUCHARA

Utilizar verticalmente, perpendicular al plato. Para tener éxito en cada presentación de plato con precisión cuando se trabaja con preparaciones líquidas (salsas, coulis, jugo, reducciones...).

2 cucharas : 1 de punta fina y 1 de punta ancha

Cuchara de acero inoxidable, mango de silicona



Réf.					
PLU03M	22,5	6,5	2	0,07	Mango de silicona

CUCHILLO THAI

Para escultura de verduras y frutas. Hoja: 5,5 cm. Hoja delgada y flexible. Puntero a la parte posterior del mango.

Acero templado, mango de bronce



Réf.				
ID1000	17	1,5	1,5	0,15

18 HERRAMIENTAS DE DECORACIÓN + PIEDRA AFILADORA

Para crear fácilmente hermosas tallas de frutas y verduras.

15 cortadores dobles de acero inoxidable en forma de «U» y «V» + 3 palpadores de acero inoxidable + 1 piedra de afilar

Acero inoxidable



Réf.				
ID2500	20,5	7,5	3	0,25

ESTUCHE DE 22 HERRAMIENTAS DE DECORACIÓN + PIEDRA AFILADORA

Panoplia completa de herramientas para la talla de frutas y verduras. Kit con espacio para almacenamiento y transporte.

4 gubias dentadas + 6 gubias redondeadas + 4 gubias de borde biselado + 5 gubias dobles + 3 cuchillas de corte + 1 piedra de afilar

Acero inoxidable



Réf.				
ID2580	30	17	4	0,4

SACABOCADOS

Creador de mordiscos refinados! Cortado y hueco. Bocaditos con fondo, para decorar con brunoise, carne picada, queso ...

Acero inoxidable

LOUIS TELLIER



Réf.			
TU01	5	0,31	Ø 5 cm
TU02	4	0,26	Ø 4 cm
TU03	3	0,18	Ø 3 cm

SET DE CORTADORES REDONDOS FOOD DESIGNER

Espesor del inox: 0,6 mm. Herramientas de diseño culinario redondas para aportar creatividad en los platos.

5 tubos redondos Ø 5 - 10 - 15 - 20 - 25 mm + 3 empujadores

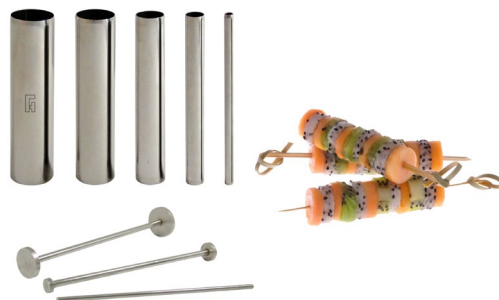
Acero inoxidable

LOUIS TELLIER

Réf.					
ID1205	17	5,5	3,5	0,14	

SET DE CORTADORES CUADRADOS FOOD DESIGNER

Espesor del inox: 0,6 mm. Herramientas de diseño culinario cuadradas para aportar creatividad en los platos.

3 cortadores de tubos cuadrados: 20x20 - 15x15 - 10x10 mm + 1 empujador doble

Acero inoxidable

LOUIS TELLIER

Réf.				
ID1207	5,5	3,5	17	0,09

SERIE DE 6 VACIADORES DE BOLA FOOD DESIGNER

6 tamaños diferentes para descorazonar, vaciar y crear bolas de frutas y verduras.

Ø : 5 / 10 / 15 / 20 / 25 / 30 mm

Acero inoxidable

LOUIS TELLIER

Réf.			
ID4100	0,5-1-1,5-2-2,5-3	2	0,12

CORTADOR DE RÁBANO EN FLOR

Rábano flores: decoración y bocados para adornar.

Acero inoxidable

LOUIS TELLIER

Réf.				
N4197	16,5	5,1	1,9	0,24

CORTADOR DE PEPINILLOS A LÁMINAS

8 hojas. Corte limpio y regular.

Acero inoxidable, PP

LOUIS TELLIER

Réf.				
N8008	17	2,5	2,5	0,03

SACAPUNTA PARA VERDURAS CON MANGO

Ø introducción: 3 cm. Hoja: 4 cm. ¡ Hacer flores con hortalizas es ahora muy fácil! Ideal por calabacines y zanahorias...

acero inoxidable, ABS



Réf.				
ID1100	3	3,8	0,05	Modelo pequeño

SACAPUNTA PARA VERDURAS - MODELO GRANDE - Ø5,5CM - HOJA 7CM

Ø introducción: 5.5 cm. Hoja: 7 cm. ¡ Hacer flores con hortalizas es ahora muy fácil! Ideal por calabacines y zanahorias...

acero inoxidable, ABS



Réf.				
ID1101	5,5	7	0,15	Modelo grande

CORTADOR ONDULADO

Aporta originalidad con un corte ondulado. Corte: 8,3 cm.

Acero inoxidable



Réf.				
ID4036	10,5	12,5	0,5	0,3

DECORADORES ESPIRAL

Para realizar guirnaldas de frutas y verduras (zanahorias, rábanos blancos, calabacines...).

Acero inoxidable



Réf.				
N7105V	1,3	1,5	0,02	A granel

PICADORA ELÉCTRICA

Con inversor de marcha.

3 rejillas: Ø 3 - 5 - 8 mm - 3 embudos: Ø 12 - 18 - 21 mm. Zócalo Kebbe.

Acero inoxidable, acero, PP

60-80 kg/h

50 Hz - 350 W
220/240 V



LT
LOUIS TELLIER

Ref.	↔	↙	⏊	📦
N5600	43	18	42	6

CUCHILLO PARA PICADORA ELÉCTRICA

Acero inoxidable



LT
LOUIS TELLIER

Ref.	📦	📏
N5600-C	0,042	N5600

JUEGO DE EMBUDOS PARA PICADORA

Ø 12, 18, 21 mm.

PP



LT
LOUIS TELLIER

Ref.	↔	↙	⏊	📦	📏
N5600-S	11	9	3	0,03	N5600

REJILLA PARA PICADORA ELÉCTRICA

Acero



LT
LOUIS TELLIER

Ref.	↔	↙	⏊	📦	🔍	📏
N5600-03	7	7	0,7	0,12	Ø 3 mm	N5600
N5600-06	7	7	0,7	0,12	Ø 5 mm	N5600
N5600-08	7	7	0,7	0,12	Ø 8 mm	N5600

REJILLA 8 RADIOS PARA PICADORA

Acero



LT
LOUIS TELLIER

Ref.	↔	↙	⏊	📦	📏
N5600-07	7	7	0,7	0,12	N5600

PICADORA ELÉCTRICA SEMI-PRO N°5

Monofásico.

Rejilla Ø53 mm, Ø agujeros 6 mm

Acero estañado, bandeja de plástico

50 kg/h

50 Hz - 400W - 230 V



Reber
Professional in meat

Ref.	↔	↙	⏊	📦
HV5-EL	39	20	25	6,9

PICADORA ELÉCTRICA SEMI-PRO N°12

Monofásico. Adecuado para cortar la garganta de cerdo para hacer patés y terrinas.

Rejilla Ø70 mm, Ø agujeros 6 m. 1 aro + 2 embudos embutidos Ø15 y 25 mm

Acero estañado, bandeja de acero inoxidable

100 kg/h

50 Hz - 500 W - 230 V



Réf.				
HV12-EL	50	30	32	13,25

PICADORA ELÉCTRICA SEMI-PRO N°22

Bifásico. Con inversor de rotación. Adecuado para cortar la garganta de cerdo para hacer patés y terrinas.

Rejilla Ø82 mm, Ø agujeros 8 mm + 1 corona

Acero estañado, bandeja de acero inoxidable

130 kg/h

50 Hz - 600 W - 230 V



Réf.				
HV22-EL	60	30	32	21

ACCESORIO PARA SALSA DE TOMATE PARA PICADORA

Rejilla agujeros Ø 1,5 mm

Acero inoxidable 304, resina acetil



Réf.					
HV1222-OPTCT	45	32	45	5,8	HV12-EL / HV22-EL
HV5-OPTCT	29	18	27	2,66	HV5-EL

PICADORA MANUAL

Para fijar sobre una mesa o superficie de trabajo.

Rejilla Ø6,5 mm

Aluminio estañado, bandeja de madera

1,15 kg/mn



Réf.					
N4022C	23,5	14	17,5	4	N°22
N4032C	39	17	38	8,6	N°32

REJILLA PARA PICADORA MANUAL

Acero

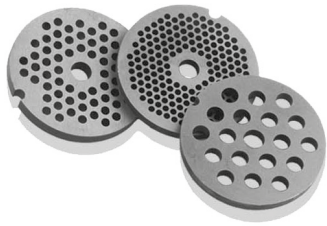

LA BONNE GRAINE

Réf.	↔	↗	⏊	📦	🔍	🔗
N40204C	8	8	1	0,21	Ø 4,5 mm	N4022C
N40206C	8	8	1	0,19	Ø 6,5 mm	N4022
N40208C	8	8	1	0,19	Ø 8 mm	N4022
N40212C	8	8	1	0,126	Ø 12 mm	N4022
N40215C	8	8	1	0,21	Ø 15 mm	N4022C
N40304C	10	10	1	0,32	Ø 4,5 mm	N4032C
N40306C	10	10	1	0,32	Ø 6,5 mm	N4032C
N40308C	10	10	1	0,29	Ø 8 mm	N4032C
N40312C	10	10	1	0,32	Ø 12 mm	N4032C
N40315C	10	10	1	0,33	Ø 15 mm	N4032C

LOTE DE EMBUDOS PARA PICADORA MANUAL

Diámetro : 13 mm - 17 mm - 19 mm.
Con travesaño.

PP



Réf.	↔	↗	⏊	📦	🔗
N4022C-S	18	11	4,5	0,068	N4022C
N4032C-S	11	11	15	0,07	N4032C

CUCHILLO PARA PICADORA MANUAL

Acero



Réf.	↔	↗	⏊	📦	🔗
N40221C	7	7	1,5	0,8	N4022C
N40321C	8,5	8,5	2	0,98	N4032C

EMBUTIDORA MANUAL 3,5L

2 abrazaderas con plástico. Se bloquea por una «camarilla» de bloqueo. Pulsador interior estanco recubierto de silicona. 2 posiciones: vertical para llenar el tanque y horizontal para su embutir.

3,5 L

4 embudos : Ø 17-21-25-29 mm

Tanque de acero inoxidable y base de epoxi



Réf.	↔	↗	⏊	📦
N5900	44	27	18	4,5

EMBUTIDORA MANUAL HORIZONTAL

Sin adición de aire: preservación óptima de la calidad de la carne.

4 embudos : Ø 15/23/28/38 mm

Acero pintado y acero inoxidable



Réf.	↔	↗	↓	📦	🔍
PSX05	60	22	22	10,6	5L
PSX08	70	22	22	11,95	6,7 L

CONJUNTO DE 3 EMBUDOS

Ø 15 - 20 - 23 mm.

PP



Réf.	↔	↗	↓	📦	🔍
N4047CXE	16	10	5	0,05	N4047C / N4047CX

LOTE DE EMBUDOS PARA SALCHICHAS

Tres tallas diferentes : 9 - 17 - 27 mm de diámetro.

PP



Réf.	📦	🔍
N5700-S	0,06	N5700

EMBUTIDORA MANUAL 2L

Para hacer chorizos y morcillas. Se suministra con tres embudos. Para atornillar.

2 L

3 embudos : Ø 14 mm - 18 mm - 22 mm

Hierro fundido



Réf.	↔	↗	↓	📦
N4047C	22	12,5	24,5	6,1

EMBUTIDORA MANUAL VERTICAL

Para hacer chorizos y morcillas. Se suministra con tres embudos. Para atornillar. Dimensiones de la base: 30 x 22 cm.

3 L

3 embudos : Ø 0,9 - 1,7 - 2,7 cm

Tanque de acero inoxidable et chasis de epoxy



Réf.	↔	↗	↓	📦
N5700	30	58	71	6,2

EMBUTIDORA MANUAL VERTICAL - INOX.

Para atornillar. Dimensiones de la base: 30 x 22 cm. Cremallera con 2 velocidades.

3 L

3 embudos : Ø 14 - 20 - 30 mm

Acero inoxidable



Réf.	↔	↗	↓	📦
N5750	42	42	76	8,6

LOTE DE EMBUDOS PARA SALCHICHAS

Tres tallas diferentes : 14 - 20 - 30 mm de diámetro.

Acero inoxidable



Réf.					
N5750-S	6	6	19	0,26	N5750

SOPORTE PARA MORCILLAS

Ø arriba : 8 cm. Ø de la base: 28 cm.

Acero inoxidable



Réf.				
NC006	28	28	3,5	0,56

PRENSA TERRINA HACCP

Adaptable a todo tipo de platos de terrina, marcos, círculos, placas gastro... Para las terrinas, después de la cocción: foie gras, mollejas de ternera, marmoleado, carnes saladas antes de ahumar, prensado para el drenaje... Presión simultánea e idéntica en continuo gracias al muelle de presión.

Acero inoxidable



Réf.				
PRESTE01	15	10	18	0,92

PRENSA PARA PATO

Para realizar la receta del pato a la sangre.

Cuenco estañado

Latón



Réf.				
NY100	52	16		Bronce. Bajo demanda.
NY300	52	16		Cromada. Bajo demanda.

REJILLA PARA SPÄTZLE - MODELO DOMÉSTICO

Para ollas y cacerolas Ø de 22 cm a 26 cm. Agujeros Ø 8 mm. Extraíble, lavavajilla. Para preparar cortas Spaetzle y Knepfle, especialidades regionales en Alsacia, Lorena y Europa Central. Llene el depósito de masa movimiento de vaivén sobre la olla de agua hirviendo.

Muesca de bloqueo para el borde de la olla/sartén

Acero inoxidable



Réf.				
N8006	33,5	11	7	0,37

REJILLA PROFESIONAL PARA SPÄTZLE

Para ollas y cacerolas > Ø 40 cm. Rejilla 39,5 x 9 cm, agujeros Ø 8 mm. Depósito deslizante sobre base PEHD. Robusta, extraíble, lavavajilla. Para preparar cortas Spaetzle y Knepfle, especialidades regionales en Alsacia, Lorena y Europa Central. Llene el depósito de masa movimiento de vaivén sobre la olla de agua hirviendo.

1,3L

Muesca de bloqueo para el borde de la olla/sartén

Acero inoxidable, PE



LOUIS TELLIER



Réf.				
SP01	85	14	18,5	1,7

MÁQUINA DE PASTA MANUAL ATLAS

Espesor ajustable: 10 grados de 4.8 mm a 0.6 mm. Laminador manual de 10 espesores y 2 accesorios.

Accesorio doble extraíble tagliolini 1,5 mm, fettuccine 6 mm + abrazadera

Acero cromado, aluminio anodizado, engranajes de acero cementado y templado, mango de metal y plástico



Réf.					
N8001	34	20,5	29	2,6	Ancho de masa 150 mm



MÁQUINA DE PASTA ELÉCTRICA ATLAS

Ancho de masa 150 mm. Espesor ajustable: 10 grados de 4.8 mm a 0.6 mm. Laminador eléctrico de 10 espesores y 2 accesorios.

Atlas 150, motor, manivela, fettuccine de 6 mm con doble enganche extraíble y tagliolini de 1,5 mm, abrazadera

Acero cromado, aluminio anodizado, engranajes de acero cementado y templado

50/60 Hz - 100 W - 220/240 V



Réf.				
N8005	34	20	18	4,5

MOTOR «PASTADRIVE» PARA ATLAS

Para alimentar las máquinas de pasta Atlas.

ABS

50/60 Hz - 100 W - 220/240 V



Réf.					
N8001-E	13	17,5	11	1,25	N8001 / N8005-110 / N7995 / N7994 / N79941 / N8000 / N8005 / N7993 / N3013.

ACCESORIO RAVIOLI PARA ATLAS

3 cavidades 45 x 45 mm.

Cuchara en la punta para verter el relleno

PS, ABS, acero cromado



Réf.							
N8004	18	11,5	9	1,45	Ravioli		N8001 / N8005 / N7994 / N79941.

SPAGHETTI ACCESORIO PARA MÁQUINA DE PASTA ATLAS

Circular sección Ø 2 mm. Compatible con máquinas Atlas 150 eléctricas y manuales.

 Aluminio anodizado y acero cromado



Réf.						
N8003	17	7	4,5	0,6	Spaghetti	N8001 / N8005 / N7994 / N79941.

CORTADOR «CHEF IN CASA» MANUAL

Para cortar las pastas a la salida de Chef in Casa. Logitud ajustable en función de la velocidad de rotación.

 ABS, aluminio anodizado, acero inoxidable



Réf.						
N7917-01	15	14	10	1,2	Manual. Bajo demanda.	N7917

MÁQUINA ELÉCTRICA PROFESIONAL PARA PASTA CHEF IN CASA

Uso professionnel. Selección amplia de pastas: 13 trefilas de bronce en opción. Amasador, laminador y trefilada. Sabor y textura de pasta a la antigua.

 2 kg

 Matriz de bronce estándar (ancho 170 mm) + 1 cuchillo giratorio manual N7917-01

 Externo de aluminio anodizado, bronce, amasadora de acero inoxidable

 6-8 kg / h

 50 Hz - 750 W - 230 V



Réf.					
N7917	29	55	30	3	Bajo demanda

CORTADOR «CHEF IN CASA» ELÉCTRICO

Permite la producción continua. Para cortar las pastas a la salida de Chef in Casa. Logitud ajustable en función de la velocidad de rotación.

 ABS, aluminio anodizado, acero inoxidable



Réf.						
N7917-02	27,5	7	8	2,1	Eléctrico. Bajo demanda.	N7917

Bronce

imperia
1899

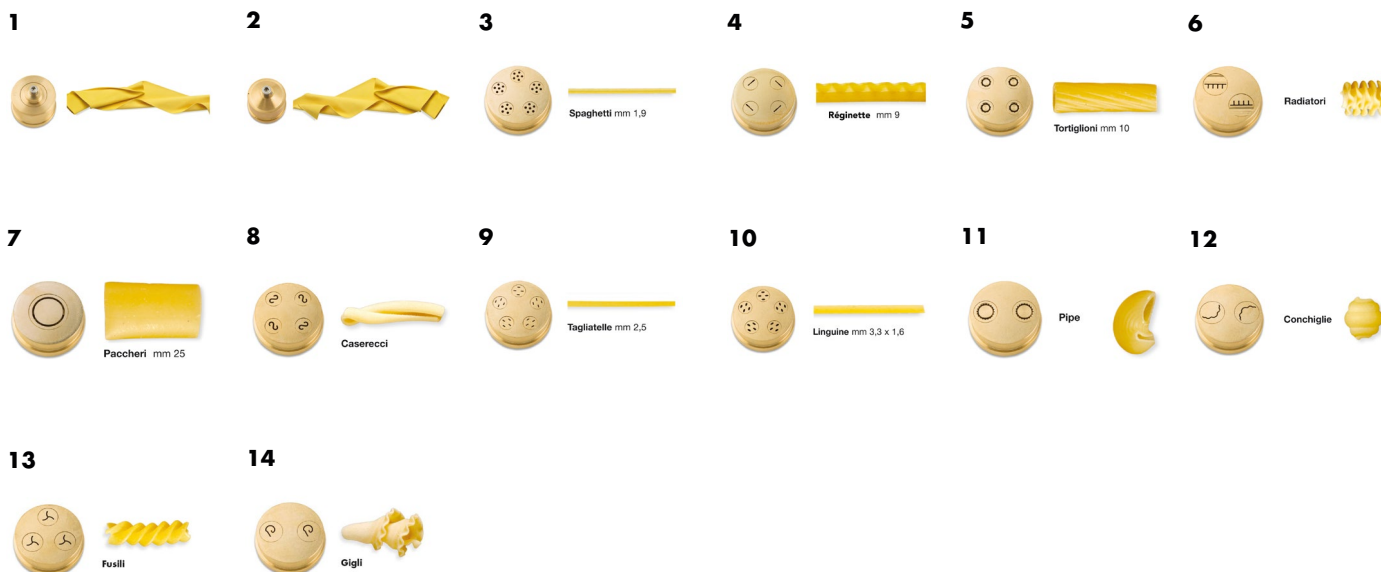

Réf.

1 TREFILA DE BRONCE CHEF IN CASA (INCLUIDO)

Se entrega con el aparato N7917. Banda de hoja.

N7917-03 0,4 100 mm. Bajo demanda. N7917

2 TREFILA DE BRONCE CHEF IN CASA

Anchura adaptada a la máquina para ravioli N7899. Banda de hoja.

N7917-04 0,4 170 mm. Bajo demanda. N7917

3 TREFILA DE BRONCE CHEF IN CASA - SPAGHETTI

Trefila tradicional en bronce, garantizando pasta áspera, que agarra mejor las salsas.

N7917-05 27,5 8 8 0,3 Espaguetis. Bajo demanda. N7917

4 TREFILA DE BRONCE CHEF IN CASA - REGINETTE

Trefila tradicional en bronce, garantizando pasta áspera, que agarra mejor las salsas.

N7917-06 0,3 Reginette. Bajo demanda. N7917

5 TREFILA DE BRONCE CHEF IN CASA - TORTIGLIONI

Trefila tradicional en bronce, garantizando pasta áspera, que agarra mejor las salsas.

N7917-07 15 12 10 0,3 Tortiglioni. Bajo demanda. N7917

6 TREFILA DE BRONCE CHEF IN CASA - RADIATORI

Trefila tradicional en bronce, garantizando pasta áspera, que agarra mejor las salsas.

N7917-08 0,3 Radiatori. Bajo demanda. N7917

7 TREFILA DE BRONCE CHEF IN CASA - PACCHERI

Trefila tradicional en bronce, garantizando pasta áspera, que agarra mejor las salsas.

N7917-09 0,3 Paccheri. Bajo demanda. N7917

8 TREFILA DE BRONCE CHEF IN CASA - CASERECCI

Trefila tradicional en bronce, garantizando pasta áspera, que agarra mejor las salsas.

N7917-10 0,3 Caserecci. Bajo demanda. N7917

Réf.

9 TREFILA DE BRONCE CHEF IN CASA - TAGLIATELLE

Trefila tradicional en bronce, garantizando pasta áspera, que agarra mejor las salsas.

N7917-11 14 14 12 0,3 Tagliatelle. Bajo demanda. N7917

10 TREFILA DE BRONCE CHEF IN CASA - LINGUINE

Trefila tradicional en bronce, garantizando pasta áspera, que agarra mejor las salsas.

N7917-12 0,3 Linguine. Bajo demanda. N7917

11 TREFILA DE BRONCE CHEF IN CASA - PIPE

Trefila tradicional en bronce, garantizando pasta áspera, que agarra mejor las salsas.

N7917-13 0,3 Pipe. Bajo demanda. N7917

12 TREFILA DE BRONCE CHEF IN CASA - CONGHIGLIE

Trefila tradicional en bronce, garantizando pasta áspera, que agarra mejor las salsas.

N7917-14 0,3 Conghiglie. Bajo demanda. N7917

13 TREFILA DE BRONCE CHEF IN CASA - FUSILI

Trefila tradicional en bronce, garantizando pasta áspera, que agarra mejor las salsas.

N7917-15 0,3 Fusili. Bajo demanda. N7917

14 TREFILA DE BRONCE CHEF IN CASA - GIGLI

Trefila tradicional en bronce, garantizando pasta áspera, que agarra mejor las salsas.

N7917-16 0,3 Gigli. Bajo demanda. N7917

MÁQUINAS DE PASTA IMPERIA - MODELO RESTAURANTE

Ancho de masa: 21 cm. Espesor ajustable 10 grados, de 4.8 mm a 0.6 mm. Laminador 10 espesores semi-profesional. Posibilidad de completar con 7 tipos de trefilas (incluyendo lasaña). Pequeño catering.

Cojinetes especiales autolubricantes para reducir el esfuerzo

Acero cromado, engranajes de acero templado

12 kg/h



Réf.	↔	↗	⊥	📦	🔍
N7900	32,5	22	27,5	9,3	Manual
N7932	31	25,5	31		electrónica
N7933	30	22	25	14,75	Eléctrica

ACCESORIOS MÁQUINA DE PASTA IMPERIA - MODELO RESTAURANTE

Compatible con las máquinas Imperia Restaurante manuales y eléctricas.

Acero cromado



Réf.	↔	↗	⊥	📦	🔍	🔗
N7900-01	28,5	8	9	2	Spaghetti Ø 2 mm. Bajo demanda.	N7900 / N7923 / N7922
N7900-02	29	9,5	10	2	Cabello de ángel 1,5mm. Bajo demanda.	N7900 / N7923 / N7922
N7900-03	29	8	10	2	Tagliatelles 2 mm. Bajo Demanda.	N7900 / N7923 / N7922
N7900-04	17,5	4,5	5	2,14	Reginette - lasañeta 12 mm. Bajo demanda.	N7900 / N7923 / N7922
N7900-05	29	6,5	7	2,09	Fetuccine 6,5 mm. Bajo demanda.	N7900 / N7923 / N7922
N7900-06	29	8	9	2,09	Lasagnette 12 mm. Bajo demanda.	N7900 / N7923 / N7922
N7900-07	30	9	8	2,18	Trenette. Bajo demanda.	N7900 / N7923 / N7922

MÁQUINA DE PASTA MANUAL I PASTA 150 CROMADA

Ancho de pasta 150 mm. Espesor ajustable: 6 grados de 2.2 mm a 0.2 mm. Laminador manual 6 espesores y 2 accesorios.

Accesorio doble extraíble tagliatelle de 2 mm, fettuccine de 6,5 mm, abrazadera, placa de pastelería

Acero cromado, mango de madera



Réf.	↔	↗	⊥	📦	🔍
N7905	34	11,5	13	2,84	Cromada

MÁQUINA DE PASTA MANUAL I PASTA 150 - ROJO

Ancho de pasta 150 mm. Espesor ajustable: 6 grados de 2.2 mm a 0.2 mm. Laminador manual 6 espesores y 2 accesorios.

Accesorio doble extraíble tagliatelle de 2 mm, fettuccine de 6,5 mm, abrazadera, placa de pastelería

Acero cromado, mango de madera



Réf.	↔	↗	⊥	📦	🔍
N7905R	34	11,5	13	2,84	Roja

MOTOR « PASTA FÁCIL »

2 velocidades. Para motorizar la máquina I Pasta y los accesorios Ravioli y Gnocchi.

ABS

50 Hz - 80 W - 220/240 V



Réf.	↔	↗	⊥	📦	🔍	🔗
N7905-E	18,5	11	13	1,31	Bajo demanda	N7905 / N7905R / N7903 / N7908 / N7905-01 / N7905-11 / N7905-07.

MÁQUINA DE PASTA ELÉCTRICA IMPERIA 150

Ancho de pasta 150 mm. Espesor ajustable: 6 grados de 2.2 mm a 0.2 mm. Laminador eléctrico 6 espesores y 2 accesorios.

Máquina para hacer pasta, motor, manivela, doble accesorio extraíble tagliatelle de 2 mm y fettuccine de 6,5 mm, pinza.

Acero cromado, ABS

50 Hz - 80 W - 220/240 V



Réf.	↔	↗	⊥	📦
N7906	47	11,5	13	2,5

ACCESORIOS MOTORIZABLES POR N7905-E

Ravioli 5x5 mm

Cortador de masa (al ancho adecuado de la hoja), cepillo.

Aluminio, ABS, madera, acero cromado



Ref.						
N7905-01	15	14	10	1,43	Ravioli 5x5 mm - 2 por línea	N7906 / N7905 / N7905R / N7903 / N7908.

ACCESORIOS MOTORIZABLES POR N7905-E

Para hacer ñoquis.

3 estampados: gnochetti sardi, cavatelli y rigatelli.

Cortador de masa (al ancho adecuado de la hoja), cepillo.

Aluminio, ABS, madera, acero cromado



Ref.						
N7905-07	15	12	10	1,16	Gnocchi	N7906 / N7905 / N7905R / N7903 / N7908.

ACCESORIOS MOTORIZABLES POR N7905-E

Para hacer ravioles o ñoquis.

Cortador de masa (al ancho adecuado de la hoja), cepillo.

Aluminio, ABS, madera, acero cromado



Ref.						
N7905-11	14	14	12	1,43	Ravioli 3x3 mm - 3 por línea	N7906 / N7905 / N7905R / N7903 / N7908.

ACCESORIOS I PASTA 150

Compatible con las máquinas Atlas 150 eléctricas y manuales.

Acero cromado



Ref.						
N7905-02	27,5	7	8	0,81	Lasaïnette de 12 mm	N7906 / N7905 / N7905R / N7903 / N7908.
N7905-03				0,73	Reginette de 12 mm	N7906 / N7905 / N7905R / N7903 / N7908.
N7905-04				0,81	Trenette de 4 mm	N7906 / N7905 / N7905R / N7903 / N7908.
N7905-05	27,5	8	8	0,8	Cabello de angel de 15 mm	N7906 / N7905 / N7905R / N7903 / N7908.
N7905-06				0,8	Espagueti de 2 mm	N7906 / N7905 / N7905R / N7903 / N7908.

ACCESORIOS I PASTA 150

Compatible con las máquinas Atlas 150 eléctricas y manuales.

Acero cromado



Ref.			
N7905-08	0,77	Pappardelle de 32 mm	N7906 / N7905 / N7905R / N7903 / N7908.

SECADOR PARA PASTA FRESCA

Hasta 1 kg de pasta. 12 barras para secar sus pastas frescamente cortadas.

Madera de haya



Ref.				
N7907	30	30	33	0,57

imperia

Rodillo de madera

Aluminio embutido, base de acero esmaltado, patas de goma



Réf.

1 **MOLDE RAVIOLIS - 36 CAVIDADES**

Ravioli: 3,4 x 3,4 cm. Gama completa de moldes de raviolis.

N7910	30	10	9	0,32	Raviolis 3,4 x 3,4 cm
-------	----	----	---	------	-----------------------

2 **MOLDE RAVIOLIS - 44 CAVIDADES**

Ravioli: 2,5 x 2,5 cm. Gama completa de moldes de raviolis.

N7911	29	10,5	1	0,23	Raviolis 2,5 x 2,5 cm
-------	----	------	---	------	-----------------------

Réf.

3 **MOLDE RAVIOLIS - 18 CAVIDADES**

Lado: 60 mm. Gama completa de moldes de raviolis.

N7912	35,5	11,5	2	0,3	Raviolis 6 x 6 cm
-------	------	------	---	-----	-------------------

4 **MOLDE RAVIOLIS - 12 CAVIDADES**

Ravioli: 5,5 x 5,5 cm. Gama completa de moldes de raviolis.

N7913	33,5	11,5	2	0,31	Raviolis 5,5 x 5,5 cm
-------	------	------	---	------	-----------------------

PALA PARA PIZZA REDONDA - MADERA

Pala pizza redonda de haya para hornear pizzas y panes. Sección 22x27 mm.

Madera de haya



LOUIS TELLIER

Réf.				
NPB28	28	1,56	1	Ø 28 cm - mango 1,25 m
NPB33	33	2,3	1,4	Ø 33 cm - mango 2 m
NPB40	40	2,3	1,85	Ø 40 cm - mango 2 m

PALA PARA PIZZA REDONDA - INOX.

Base Ø 32 cm. Mango 96.5 cm. Pala pizza inox para hornear pizzas y panes.

Acero inoxidable



LOUIS TELLIER

Réf.				
NPX31	32	1,2		Redonda

PALA PARA PIZZA CUADRADA - INOX.

Base 32x32 cm. Mango 96.5 cm. Pala pizza inox para hornear pizzas y panes.

Acero inoxidable



LOUIS TELLIER

Réf.					
NPX30	127,03	32	1,2		Cuadrada

RUEDA CORTADORA PARA PIZZA

Mango de madera



Réf.			
N3702	10	3	0,19

GUITARRA CON ALAMBRE



LOUIS TELLIER

BIEN NE REMPLACE LE FAIT MAINT



Made in France

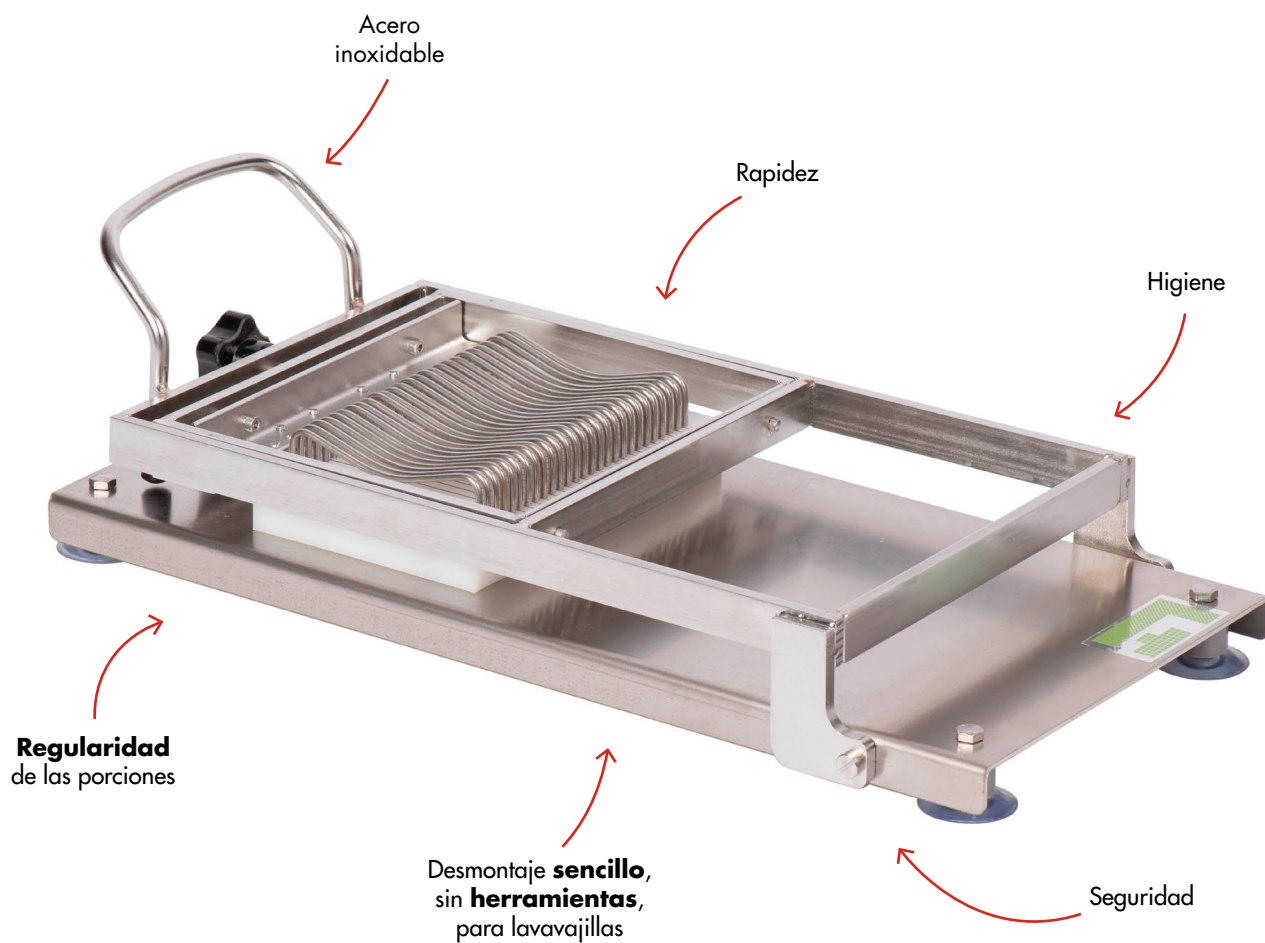
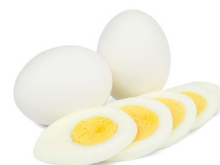
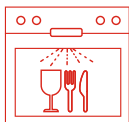

Para foie-gras, mousses, frutas blandas, quesos, mozzarella, feta, mantequilla, huevos duros, salchichas, remolachas... cualquier producto de consistencia blanda y homogénea.

2 tamaños : mín. (longitud de corte : 14,5 cm) o máx. (30 cm) equipados a elegir :

- De una cuna hueca para productos redondos,
- De una cuna plana para productos planos,
- Ancho de corte a elegir entre 5, 7 o 10 mm.

MINI GUITARRA PARA PRODUCTOS REDONDOS

Corte limpio y regular. Longitud de corte : 14,5 cm.

Acero inoxidable



LOUIS TELLIER

Réf.					
GX01	45,5	23,3	13,5	4,9	Rebanadas de 5 mm
GX03	45,5	23,3	13,5	4,9	Rebanadas de 10mm

MINI GUITARRA PARA PRODUCTOS PLANOS

Longitud de corte : 14,5 cm.

Acero inoxidable



LOUIS TELLIER

Réf.					
GX02	45,5	23,3	13,5	4,9	Rebanadas de 5 mm
GX04	45,5	23,3	13,5	4,9	Rebanadas de 10 mm

SOPORTES REDONDO PARA MINI GUITARRA

Acero inoxidable



LOUIS TELLIER

Réf.			
GX012	0,65	5 mm Soporte redondo	GX01 / GX02
GX014	0,65	10 mm Soporte redondo	GX03 / GX04
GX022	0,65	5 mm Soporte plano	GX01 / GX02
GX024	0,65	10 mm Soporte plano	GX03 / GX04
GX052	0,32	7 mm Soporte redondo	GX05 / GX06
GX053	0,32	7 mm Soporte plano	GX05 / GX06

MAXI GUITARRA PARA PRODUCTOS PLANOS

Corte limpio y regular. Longitud de corte : 30 cm.

Acero inoxidable

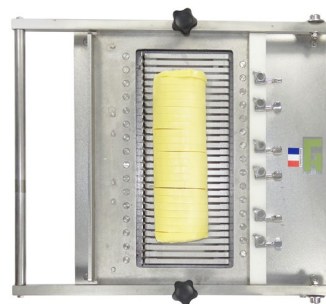

LOUIS TELLIER

Réf.					
GXM06	49	43,8	9,4	7,6	Rebanadas de 7 mm
GXM04	49	43,8	9,4	7,6	Rebanadas de 10 mm

MAXI GUITARRA PARA PRODUCTOS REDONDOS

Corte limpio y regular. Longitud de corte : 30 cm.

Acero inoxidable



LOUIS TELLIER

Réf.					
GXM03	49	43,8	9,4	8,9	Rebanadas de 10 mm
GXM05	49	43,8	9,4	8,9	Rebanadas de 7 mm

SOPORTES REDONDOS PARA MAXI GUITARRA

Acero inoxidable



LOUIS TELLIER

Réf.			
GXM012	0,7	10 mm Soporte redondo	GXM03 / GXM04
GXM022	0,94	10 mm Soporte plano	GXM03 / GXM04
GXM052	0,62	7 mm Soporte redondo	GXM05 / GXM06
GXM053	0,85	7 mm soporte plano	GXM05 / GXM06

HILOS DE REPUESTO PARA MINI GUITARRA

Cables de repuesto para modelo de miniguitarra.

Acero inoxidable



Réf.			
GX015-2	0,04	0,05	8 x 2 hilos
GXM015-2	0,04	0,08	4 x 6 hilos

SECCIONADOR PARA QUESO

Corte : Ø 15 cm. Porciones iguales rápidamente. Fácil de limpiar.

Acero inoxidable, HDPE



Réf.					
PF01	27	20	26	2,5	6 y 8 porciones
PF06	27	20	26	2	6 porciones
PF08	27	20	26	2	8 porciones

CORTADOR DE QUESO Y FOIE GRAS CON HILO Y BANDEJA

Anchura de corte: 14 cm. Para foie gras, mantequilla, queso de cabra y quesos azules.

Acero inoxidable



Réf.				
N3506	27	22,5	3	0,63

CORTADORA DE PATÉS DE INOX

Anchura de corte: 13 cm. Longitud de corte: 30 cm.

Acero inoxidable



Réf.					
CTER01	57	22	22,5	7,6	Corte 10 mm
CTER02	57	22	22,5	7,6	Corte 7 mm

RALLADORA GIROLLE GIRATORIA PARA QUESO

Corte: Ø 17 cm. El original.

Base de madera de arce certificada FSC

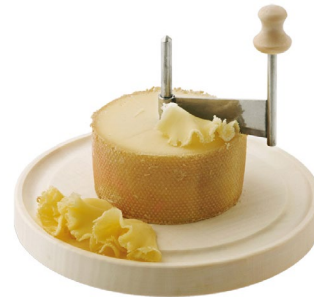

Réf.			
N3027	22	15,5	0,8

LOTE DE 5 HILOS DE RECAMBIO PARA CORTADOR DE QUESO

Acero inoxidable



Réf.					
N35061	22	12	0,1	0,3	N3506

LIRA

Perfecto para foie gras, mantequilla, queso de cabra, queso fresco, etc.

Acero inoxidable

BEST
SELLER



Réf.				
N3500	12	12,5	0,1	
N3503		17	21	0,17
N3504		21	26	0,2

LOTE DE 10 HILOS DE REPUESTO

Acero inoxidable

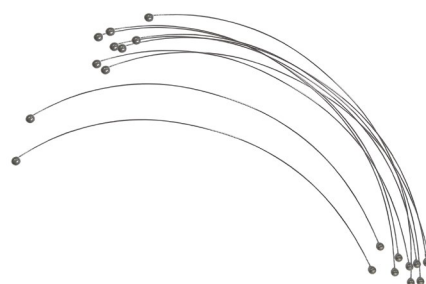

Réf.			
N35031	17	0,01	N3503
N35041	21	0,01	N3504

LOTE DE 10 HILOS PARA CORTAR QUESO

Permite el corte de queso, mantequilla y foie gras.

Acero inoxidable, PP



Réf.		
N3515	60	0,16

RALLADOR PARA QUESO - MANOS LIBES

SAN, PP, HDPE, acero inoxidable

ONE·TOUCH™



Réf.			
KRFA01	5,4	18	0,36

RALLADOR FINO

Sobre pie para una mejor estabilidad. Para chocolate, parmesano, etc.

Acero inoxidable



LOUIS TELLIER

Réf.				
300RP	40	13,5	4	0,9

RALLADORA PARA NUEZ MOSCADA

Tanque

Acero inoxidable



Réf.				
N4190	4,5	2,6	14	0,03

ABRE HUEVOS



LOUIS TELLIER



Corta con **precisión** las cáscaras de huevos crudos o pasados por agua

Acero inoxidable

Eficaz : garantiza un corte **neto y preciso** de la cáscara

Ø de corte : 3,5 cm

Higiénico : proporciona una solución **limpia y sencilla** para cortar los huevos sin rebabas





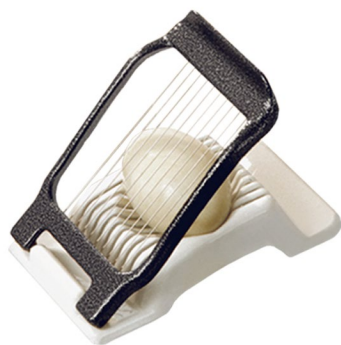

Los chefs gastronómicos y las empresas de catering también lo utilizan para realizar una cocina creativa : la concha, una vez vaciada, se transforma en un contenedor original para huevos revueltos con trufa, huevos rellenos de chocolate, etc. Infinitas posibilidades de realización de menús apetitosos tanto para la vista como para el paladar.

CORTADOR DE HUEVOS EPOXY - RODAJAS

 Aluminio fundido pintado con epoxy







Réf.				
N4184	13,5	8	3,3	0,15

CORTADOR DE HUEVOS INOX - RODAJAS

 Acero inoxidable





LOUIS TELLIER

Réf.				
N4184X	16	8,5	2	0,2

CORTADOR DE HUEVOS





6 secciones. Para sus ensaladas, sus platos o como decoración.

 Acero inoxidable

BEST SELLER





LOUIS TELLIER

Réf.				
N4188X	21	6,5	2,5	0,13

CLARIFICADOR PROFESIONAL DE HUEVOS





Diseñado para ser instalado sobre un contenedor GN 1/4.

 Acero inoxidable

 1 000 pcs /h





LOUIS TELLIER

Réf.				
SPOE01	30,5	10	10,5	0,5



ABRE HUEVOS

Ø de corte: 3 cm. Una apertura limpia y precisa de la cáscara de los huevos crudos o pasados por agua.

 Acero inoxidable



LOUIS TELLIER

Réf.			
N4183	3	11	0,7

CORTADOR DE PAN CON TOPE



LOUIS TELLIER
BIEN NE REMPLACE LE PAIN MARIÉ



Fabrication Française



Corte rebanadas regulares y perfectas sin que se aplasten, incluso los panes y las baguettes recién salidos del horno.

Modelos disponibles con zócalo de madera y zócalo PEHD APPCC.

Atención : se recomienda utilizar guantes anticorte.

CORTADOR DE PAN HOJA REDONDA

Corte perfecto sin aplastar. Rebanadas regulares. Cuchilla dentada perfilada en 1/2 luna de 25 cm. Tope ajustable para rebanadas de 5 a 85 mm. Carcasa de seguridad para proteger los dedos. Estabilidad mediante ventosas.

Hojas de acero inoxidable templado



LT
LOUIS TELLIER

Réf.					
703SF1	22	39	25	3,4	Base de madera
703SF1P	22	39	25	3,4	Base de HDPE HACCP
703SX	22	39	25	3,4	Base de inox HACCP

CORTADOR DE PAN CON BASE DE MADERA

Hoja recta de 35 cm.

Base de madera y hojas de acero inoxidable



Réf.				
N7004	40	11	15	2,2

CORTABAGUET

Cuchilla corta: abre por la mitad. Seguridad: evita cortarse. Fácil y rápido: introducir 1/2 baguette por un lado y tirar por el otro.

Fijación de abrazadera

Acero inoxidable



LT
LOUIS TELLIER

Réf.					
FVX1	19,5	6	22,5	1,14	Corte «libro»

CORTADOR DE PAN CON BASE INOX.

Hoja recta de 35 cm. Corte eficaz con el efecto guillotina.

Guardia de seguridad para la protección de los dedos. Almohadillas antideslizantes.

Hojas de acero inoxidable templado

BEST SELLER



LT
LOUIS TELLIER

Réf.				
35CPX	53	13	16	2,3



CORTADOR DE PAN CON BASE DE MADERA - PRIMER PRECIO

Hoja recta de 25 cm.

Base de madera y hojas de acero inoxidable



Réf.				
N7013	40	12	7,5	0,94

CORTA TORTILLA

Acero inoxidable



Réf.				
TORT06	25	21	0,25	6 secciones
TORT08	25	21	0,25	8 secciones

COLORES APPCC (HACCP)



Amarillo :
ave crudo

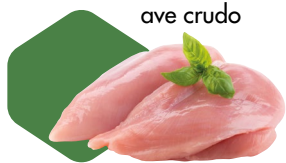

Violeta :
alimentos no alérgeno
(por ej. Sin gluten)



Verde :
frutas y verduras



Rojo :
carne cruda



Azul :
pescados y mariscos
crudos



Marrón : carne cocida
y charcutería



Blanco :
productos lácteos, pan,
queso, pastelería



Tablas de corte con código de color conforme con el procedimiento APPCC :
un color para cada tipo de alimentos para evitar las contaminaciones cruzadas.

TABLA DE CORTAR HDPE 500 - NEGRA

GN 1/1. Ideal para el bar.

HDPE



LOUIS TELLIER

Réf.				
NPP11-N	53	32,5	2	3

TABLA DE CORTAR HDPE 500 CON RANURA PARA JUGOS - BLANCA

Color especial HACCP para productos lácteos, pan y bollería. Con ranura. Calidad superior.

HDPE



LOUIS TELLIER

Réf.				
NPP41	40	30	2	1,5
NPP51	50	30	2	3
NPP61	60	40	2	4,65

TABLA DE CORTAR HDPE 500 - BLANCA

Calidad superior. Color especial HACCP para productos lácteos, pan y bollería.

HDPE



LOUIS TELLIER

Réf.				
NPP4	40	30	2	1,5
NPP5	50	30	2	3
NPP6	60	40	2	4,65

TABLA DE CORTAR DE PE INYECTADO - BLANCA

Color especial HACCP para productos lácteos, pan y bollería. Con ranura y mango. Calidad superior.

PE



Réf.				
NPP2	35	25	1	0,67

TABLA DE CORTAR HDPE 500 - VIOLETA

Color especial HACCP para los alimentos no alergénicos. Calidad superior.

HDPE



LOUIS TELLIER

Réf.				
NPP6-P	60	40	2	4,66

TABLA DE CORTAR HDPE 500 - MARRÓN

Color especial HACCP para la carne cocida y los embutidos. Calidad superior.

HDPE



LOUIS TELLIER

Réf.				
NPP4-M	40	30	2	1,43
NPP6-M	60	40	2	4,65

TABLA DE CORTAR HDPE 500 CON RANURA PARA JUGOS - MARRÓN

Color especial HACCP para la carne cocida y los embutidos. Calidad superior. Con ranura y mango.

 HDPE



LT
LOUIS TELLIER





Réf.				
NPP51-M	50	30	2	3
NPP61-M	60	40	2	4,65

TABLA DE CORTAR HDPE 500 - ROJA

Color especial HACCP para la carne cruda. Calidad superior.

 HDPE

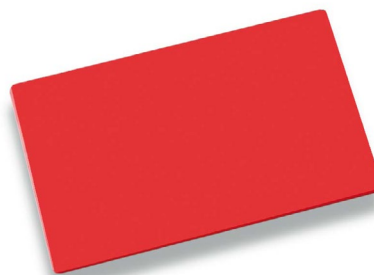

LT
LOUIS TELLIER





Réf.				
NPP4-R	40	30	2	1,5
NPP5-R	50	30	2	3
NPP6-R	60	40	2	4,65
NPP11-R	53	32,5	2	1,97

TABLA DE CORTAR HDPE 500 - AZUL

Color especial HACCP para pescados y mariscos crudos. Calidad superior.

 HDPE



LT
LOUIS TELLIER





Réf.				
NPP4-B	40	30	2	2
NPP5-B	50	30	2	3
NPP6-B	60	40	2	4,65

TABLA DE CORTAR HDPE 500 - VERDE

GN 1/1. Color especial HACCP para las frutas y las verduras. Calidad superior.

 HDPE

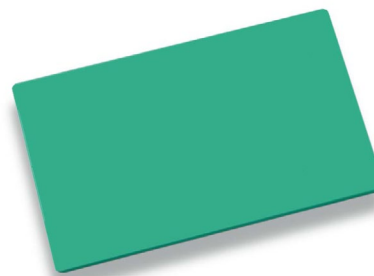

LT
LOUIS TELLIER





Réf.				
NPP11-V	53	32,5	2	1,97
NPP4-V	40	30	2	2,4
NPP5-V	50	30	2	3
NPP6-V	60	40	2	4,65

TABLA DE CORTAR HDPE 500 - AMARILLA

Color especial HACCP para la ave cruda. Calidad superior.

 HDPE

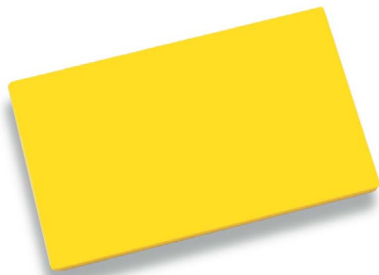

LT
LOUIS TELLIER





Réf.				
NPP4-J	40	30	2	1,5
NPP5-J	50	30	2	3
NPP6-J	60	40	2	4,65
NPP11-J	53	32,5	2	1,97

TABLA DE CORTAR PE ECO - BLANCA

Color especial HACCP para productos lácteos, pan y bollería.

 PE «ECO» de baja densidad



LT
LOUIS TELLIER





Réf.				
NPP7	40	30	2	2,22
NPP8	50	30	2	2,8
NPP9	60	40	2	4,3
NPP14	60	40	1,5	3,4

TABLA DE CORTAR PE ECO - AZUL

Color especial HACCP para pescados y mariscos crudos.

PE «ECO» de baja densidad



LOUIS TELLIER

Réf.				
NPP8-B	50	30	2	2,8
NPP9-B	60	40	2	4,3

TABLA DE CORTAR PE ECO - ROJA

Color especial HACCP para la carne cruda.

PE «ECO» de baja densidad

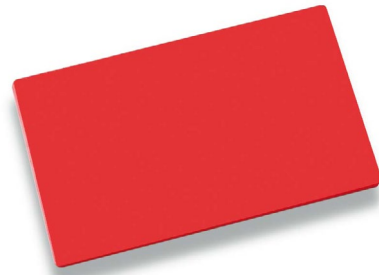

LOUIS TELLIER

Réf.				
NPP8-R	50	30	2	2,8
NPP9-R	60	40	2	4,3

TABLA DE CORTAR PE ECO - VERDE

Color especial HACCP para las frutas y las verduras.

PE «ECO» de baja densidad

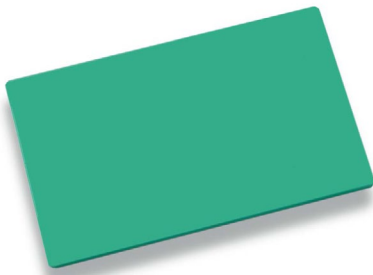

LOUIS TELLIER

Réf.				
NPP8-V	50	30,5	2	2,8
NPP9-V	60	40	2	4,3

TABLA DE CORTAR PE ECO - AMARILLA

Color especial HACCP para la ave cruda.

PE «ECO» de baja densidad

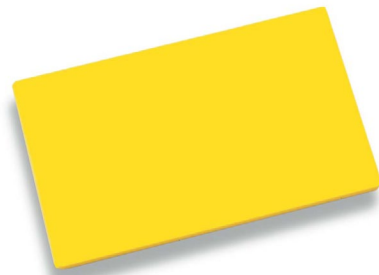

LOUIS TELLIER

Réf.				
NPP9-J	60	40	2	4,3

LOTE DE 6 TABLAS DE CORTAR

1 tabla de cortar: 355g y 3mm de espesor. Colores del HACCP para evitar la contaminación cruzada.

Con soporte

HDPE



Réf.				
NPPC	40	30	0,3	2,13

TABLA DE CORTAR DE MADERA CON RANURA PARA JUGOS

Con ranura y reserva de jugo.

Madera de haya - PEFC



Réf.				
NPB07	50	30	2,5	1,31

TABLA DE CORTAR DE MADERA CON RANURA PARA JUGOS LT

Con una risa. En madera natural.

Madera de haya - PEFC



LOUIS TELLIER

Ref.	↔	↙	⊥
LT2131	40	26	2

TABLA DE CORTAR DE MADERA PARA PEREJIL - CAKE - CHORIZO

Con asa. Para cortar o presentar.

Madera de haya



Ref.	↔	↙	⊥	📦	🔍
NPPL28	34	14	1,5	0,33	PEFC
NPPL40	39	16	1,5	0,45	PEFC
NPPL45	44	20	1,5	0,54	PEFC

CEPILLO

Para cepillar tablas y alisarlas quitando las marcas de corte de los cuchillos.

HDPE



Ref.	↔	↙	⊥	📦
NPPR1	17,7	6,4	8,7	0,37

TABLA/PALA DE PIZZA LT

Doble funcion. Ideal para restaurantes o eventos.

Madera de haya - PEFC



LOUIS TELLIER

Ref.	↔	↙	⊥	📦
LT2101	56,5	29	1,2	non

RASCADOR

Cuchilla 2 filos, se puede afilar. Para cepillar el polietileno y quitar las marcas de cuchillos

Hoja de acero templado, body en material compuesto



Ref.	↔	↙	⊥	📦
NPPR	23	6,5	4,3	0,22

HOJA DE RECAMBIO

Cuchilla 2 filos que se puede afilar.

Acero templado



Ref.	↔	↙	⊥	📦	🔗
NPPR01	6,4	2	0,4	0,2	NPPR / NPPR1

RACK RECOGE-TABLAS

Para 6 tablas. Hielo 6 mm.

4 almohadillas

Acero inoxidable

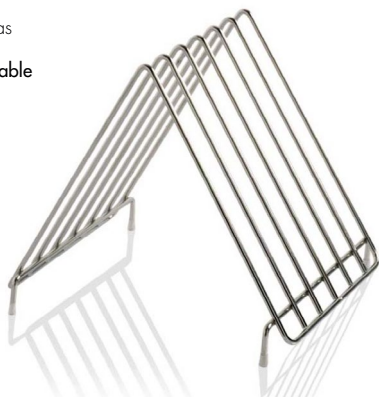

LOUIS TELLIER

Ref.				
NC016	32	26,5	30	1,15

GUANTE RESISTENTE AL CORTE

Talla S, M, L y XL disponibles.

Polietileno de alto rendimiento



Réf.	↔	↗	⊥	🔍
LT21P001	23,5	13,5	0,3	Talla S
LT21P002	26,5	15	0,3	Talla M
LT21P003	27,5	14,5	0,3	Talla L
LT21P004	28,5	16,5	0,3	Talla XL

GUANTE COTA DE MALLAS

Reversible - Hilo: Ø 0,5 mm. Para los mataderos, carniceros, charcuteros, etc. Limpieza enérgica con un cepillo y agua a 50°C.

Acero inoxidable y poliuretano

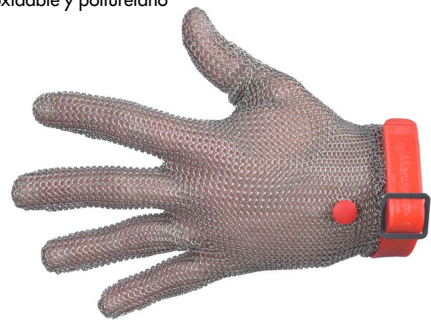

Réf.	📏	🔍
N3091	0,14	M - 8-8,5 - Rojo
N3092	0,14	L - 9-9,5 - Azul

AFILADOR DE CUCHILLOS CON MANGO

Para un afilado rápido y seguro.

Hoja de carburo de tungsteno, cuerpo de ABS, mango de PE de alta densidad



Réf.	↔	↗	⊥	📦
AFFU-M	14,5	7	1,5	0,04

EXPOSITOR DE MOSTRADOR DE 10 AFILADORES

Cartón



Réf.	↔	↗	⊥	📦	📏
BAFFU-M	20,5	15	8	0,54	ALFFU-M

TIJERAS HOJAS MÚLTIPLES

Hoja: 8 cm. Hierbas cinceladas 5 veces más rápido.

5 cuchillas

Hoja de acero templado



Réf.	↔	↗	⊥	📦
CIS05B	20	7	1,5	0,13

TIJERAS UNIVERSALES

Hoja: 8 cm.

Hoja de acero templado



Réf.	↔	↗	⊥	📦
N3422	21,5	7,5	1	0,8

CUCHARA DE HAYA

Certificado PEFC.

Madera de haya - PEFC



Ref.					
NM20-1	20,3	5	1,5	0,03	20 cm
NM25-1	25	5	1	0,03	25 cm
NM30-1	30,2	4,8	1,5	0,04	30 cm
NM35-1	34,8	5,2	1,5	0,04	35 cm
NM40-1	40,5	5	1,5	0,05	40 cm

ESPÁTULA OBLICUA DE HAYA

Madera de haya - PEFC



LOUIS TELLIER



Ref.					
NSPB25-1	25	5	1	0,02	25 cm
NSPB30-1	30	5	1	0,03	30 cm
NSPB35-1	35	5	1	0,04	35 cm
NSPB40-1	40	5	1	0,06	40 cm

ESPÁTULA DE HAYA

Madera de haya - PEFC



Ref.					
NSPO25-1	25	4,5	0,8	0,14	25 cm
NSPO30-1	30	5	1	0,18	30 cm
NSPO35-1	35	5,2	1	0,04	35 cm
NSPO40-1	40	5,4	1	0,07	40 cm
NSPO50	50,4	7,5	1,2	0,15	50 cm
NSPO60	60	7,5	1	0,18	60 cm
NSPO80	80	9	1	0,24	80 cm
NSP100	100	10	2	0,6	100 cm
NSP120	120	10	2	0,59	120 cm

CUCHARA

Lavable en lava-vaajillas. No raya los revestimientos antiadherentes.

Material compuesto de alta temperatura

+ 220°C



Réf.			
NMPA30	30	0,76	30 cm
NMPA40	40	0,98	40 cm
NMPA45	45	0,13	45 cm

ESPÁTULA

Lavable en lava-vaajillas. No raya los revestimientos antiadherentes.

Material compuesto de alta temperatura

+220°C / +428°F



Réf.					
NSPA25	25	4	1	0,3	25 cm
NSPA30	30	4,8	1	0,52	30 cm
NSPA35	35	5,7	1	0,7	35 cm
NSPA40	40	6,5	1	0,12	40 cm
NSPA45	45	7,4	1	0,12	45 cm
NSPA50	50,3	8	1	0,16	50 cm
NSPS28	28,5			0,5	28,5 cm
NSPS29	0,05	29,5	6	0,054	29 cm
NSPS31	31,5	7	1,5	0,5	31 cm

ESPÁTULA DE GOMA

Cabezal flexible para raspar los bordes o el fondo de un recipiente y mezclar preparaciones delicadas como claras de huevo.

Caucho, mango de madera

-50°C a +65°C / -58°F a +149°F



Réf.				
NMB25-1	25	5	1	0,21

ESPÁTULA PROFESIONAL PERFORADA HDPE

Apto para lavavajilla. Para grandes cocinas.

HDPE

+85°C / +185°F



Réf.					
NSPT100	100	10	2,5	0,9	100 cm
NSPT120	120	10	2,5	1,1	120 cm

ESPUMADERA ARAÑA - MALLA INOX.

Robusto : hilo de cuello continuo bajo el tamiz. Para recuperar y escurrir los alimentos durante la cocción.

Gancho curvo : suspensión y canto de olla

Acero inoxidable



LOUIS TELLIER

Réf.	Ø	I	Peso	Ø
NC001	12	7,5	0,12	Ø 12 cm
NC010	16	16	0,26	Ø 16 cm
NC003	18	13	0,41	Ø 18 cm
NC057	20	20	0,43	Ø 20 cm
NC004	22	17,8	0,48	Ø 22 cm
NC005	26		0,6	Ø 26 cm

ESPUMADERA ARAÑA TEJIDA

Robusta: alambre del mango continuo bajo la malla.

Gancho curvo : suspensión y canto de olla

Acero inoxidable



LOUIS TELLIER

Réf.	Ø	I	Peso	Ø
NC1011460	14	15	0,17	Ø 14 cm
NC1011660	16	14,5	0,27	Ø 16 cm
NC1012860	28	25	0,81	Ø 28 cm

ESPUMADERA PROFESIONAL DE INOX.

Para recuperar y escurrir los alimentos durante la cocción.

Acero inoxidable



LOUIS TELLIER

Réf.	Ø	I	Peso
LT2120	8	37	0,17
LT2121	10	41,5	0,23
LT2122	12	48	0,29
LT2123	14	54	0,38
LT2124	16	57	0,45
LT2125	18	62	0,57
LT2126	20	66	0,5

CUCHARÓN PROFESIONAL DE INOX.

Acero inoxidable



LOUIS TELLIER

Réf.	Ø	I	Peso	Capacidad
LT2102	6,5	36	0,16	70 ml
LT2103	8	40	0,23	130 ml
LT2104	9	42	0,28	200 ml
LT2105	10	44	0,36	250 ml
LT2106	11	46	0,39	300 ml
LT2107	12	49	0,45	450 ml
LT2108	14	52	0,52	670 ml
LT2109	16	58	0,68	1000 ml
LT2110	18	63	0,8	1500 ml
LT2111	20	64,5	0,9	2000 ml

ESPUMADERA REFORZADA

¡Robusto y práctico con su asa larga para recuperar con seguridad los alimentos que se están cocinando! Tamiz de lona : 23 x 28 cm.

Doble gancho: suspensión y canto de olla

Acero inoxidable

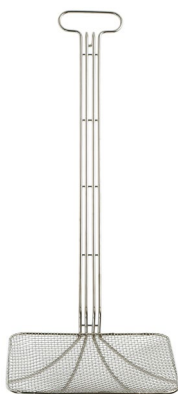

LOUIS TELLIER

Réf.				
NC1017260	81,2	28,4	14,7	1,1

ESCURRIDOR PARA FRITOS

Acero inoxidable



LOUIS TELLIER

Réf.			
N4039X	39	16	1

COLADOR CÓNICO DE INOX. CON PATA

2 asas para un fácil manejo. Sobre pies para una estabilidad óptima.

Acero inoxidable



LOUIS TELLIER

Réf.			
LT2112	24	14	0,82
LT2113	28	15	0,96
LT2114	32	17	1,13
LT2115	36	21,5	1,4
LT2116	40	25	1,77

BANDEJAS JAPONESAS CON REJILLA

Acero inoxidable 18.8



LOUIS TELLIER

Réf.				
N3992	21,5	15,1	1,8	0,26
N3993	25,6	17,6	1,8	

BANDEJA CON REJILLA

Recuperación del excedente revestimiento para reutilizarlo. Ideal para enfriar, bañar, pintar y secar.

Acero inoxidable



Réf.				
N3995	26	19	2	0,36

PINZA PARA EMLATAR

Extremos acanalados. Ranuras antideslizantes. La pinza de los chefs: fina, larga y sólida. Se utiliza en cocina para emplatar. Muy precisa.

Acero inoxidable



LOUIS TELLIER

Réf.				
PAP4	30,5	1	1	0,09

MINI PINZA PARA EMPLATAR

Información específica: Extremos acanalados. Ranuras antideslizantes. Pinza recta diseñada para colocar y decorar los platos.

Acero inoxidable



LOUIS TELLIER

Réf.				
PAP5	15,8	1	0,6	0,02

PINZA PARA SUSHI Y SASHIMI

Extremos acanalados. Ranuras antideslizantes. Pinza acodada para agarre horizontal.

Acero inoxidable



LOUIS TELLIER

Réf.		
PAP6	15	0,02

ABRELATAS ELÉCTRICO PARA COLECTIVIDADES

LOUIS TELLIER
BIEN NE REMPLACE LE FAIT MAINT

Desmontaje del «cabezal de apertura» sin herramienta para una limpieza diaria en lavavajillas y esterilización

Motor de alto rendimiento y **bajo consumo** de energía*

Apertura de todas las latas **cilíndricas** o **rectangulares**, incluso abolladas de 5 a 27 cm de altura

Apertura limpia : ausencia de limaduras en el interior de la lata. Percusión y apertura de la lata con un **solo** movimiento y con la misma palanca

Rendimiento :
de **40 a 80 latas 5x1**
en continuidad

Accesorios **imantados** para retención e la tapa

Abrelatas eléctrico profesional para colectividades de 300 o 800 cubiertos :

- Fabricación con materiales inoxidables. La rueda, por motivos de dureza, es a cero templado y está tratada contra la oxidación.
- Motor de dos velocidades protegido por una tapa duralinox.
- Motorreductor de alto rendimiento.
- Reductor completamente de metal (engranajes metálicos montados en rodamientos de bolas).
- Conjunto «motor-cabezal de apertura» de desplazamiento vertical asistido por muelle de gas permite un posicionamiento sin esfuerzo según la altura de la lata a abrir.
- Tope de ajuste de altura de las latas.
- El cambio de las piezas de desgaste (cuchilla y rueda) puede ser realizado o por personal no calificado.
- Aparato de sobremesa : base de acero inoxidable y 4 ventosas

Modelo patentado

*Detalles motor : 230 V monofásico - 50 Hz / 60 Hz

Potencia : 75 W - Par : 13 N/m

Reducción piñonería metálica

ABRELATAS ELÉCTRICO PARA COLECTIVIDADES

2 velocidades (80 r.p.m./125 r.p.m.). 80 latas en continuo. Monofásico. IP41. Para colocar sobre una mesa. Desplazamiento vertical asistido. Para 300 a 800 comensales. Apertura de todo tipo de latas cilíndricas o rectangulares, incluso abolladas, desde 5 hasta 27 cm de altura. Fácil de desmontar y limpiar. NF (higiene para alimentos) + HACCP.

Cuchilla reversible doble vida, 1 rueda Ø36 mm, 1 cepillo metálico, base con 4 ventosas, imán para sujetar la tapa

Acero inoxidable

50/60 Hz - 75 W - 230 V



Réf.					
OE750	45	25	13,2	75	13,2

KIT DE REPUESTO PARA ABRELATAS ELÉCTRICO OEXTC

1 rueda Ø36 mm, 1 cuchilla, 1 arandela de acero inoxidable, 1 arandela curva, 1 cepillo metálico y 1 llave de rueda (no visible en la foto)

Acero inoxidable e acero laminado



Réf.		
OE896	0,14	OEXTC

ABRELATAS ELÉCTRICO PROFESIONAL GRAN CAPACIDAD

IP55. Para fijar en la mesa. Desplazamiento vertical asistido por muelle neumático. Sujeción magnética de la tapa. 800 cubiertos o más. Trabajo en continuo. Apertura de todo tipo de latas cilíndricas o rectangulares, incluso abolladas de 5 a 27 cm de altura. Fácil de desmontar y limpiar. NF (higiene para alimentos) + HACCP.

Pedal de mando, hoja reversible doble vida, 2 ruedas: Ø36 mm para platos rectangulares y redondos, Ø70 mm para platos redondos, 1 cepillo metálico.

Acero inoxidable

400-500 pcs / h

50/60 Hz - 260 W



Réf.				
OE750M	32	75	32	230 V monofásico
OE750M-110	32	75	30	110 V. Bajo demanda.
OE750T	32	75	32	380 V Trifásico. Bajo demanda.

KIT DE REPUESTO PARA ABRELATAS ELÉCTRICO OE750

1 rueda Ø36 mm, 1 rueda Ø70 mm, 1 cuchilla, 1 cepillo metálico y 1 llave de rueda (no visible en la foto)

Acero inoxidable e acero laminado



Réf.		
OE7502	0,41	OE750M / OE750T / OE750M-110

KIT ALZADOR 12CM

Permite levantar la columna para abrir latas de hasta 39 cm de altura.

Acero inoxidable



Réf.			
OE750X	1,19	Bajo demanda	OE750

BANDEJA GIRATORIA PARA LATAS REDONDAS 5X1 Y 3X1

Se coloca delante del abrelatas gran capacidad para ayudar en el giro de las latas. Comodidad de utilización, sin rozamiento. Lavable.

Rodamiento de bolas

Acero inoxidable



Réf.					
OE7620.	22	22	3,5	2,3	OE750M / OE750T / OE750M-110
OE7620-B					OE750

HOJA REVERSIBLE INOX PARA OEXTC Y OE750

No afile la cuchilla. Reversible: doble vida.

Acero inoxidable



LOUIS TELLIER

Réf.			
O2830-5	0,05	OEXTC / OE750M / OE750T / OE750M-110	

MOLETA PARA OE750

Para OE750 (latas redondas).

Acero templado



LOUIS TELLIER

Réf.			
OE7553	0,7	0,03	OE750M / OE750T / OE750M-110

CEPILLO METÁLICO

Limpiar la ruleta todos los días con el cepillo metálico.

Cerdas de acero inoxidable



LOUIS TELLIER

Réf.	
OEX821	0,03

LOTE DE 5 ARANDELAS COURBANE

Elástico.

Elastómero



LOUIS TELLIER

Réf.	
O2873-5	0,05

LOTE DE 2 MOLETA PARA OEXTC Y OE750

Para OEXTC (todas las cajas estándar), OE750 (cajas rectangulares).

Acero templado



LOUIS TELLIER

Réf.			
OE7554-2	0,36	0,02	OEXTC / OE750M / OE750T / OE750M-110

PUESTO DE TRABAJO CON RUEDAS PARA OE750

Por encargo. Para abrelatas de gran capacidad para fijar.

4 ruedas incluyendo 2 frenos 1 cajón 1 estante inferior

Acero inoxidable



LOUIS TELLIER

Réf.							
PTX21	80	70	85	50	Bajo demanda	OE750	

ABRELATAS ELÉCTRICO PROFESIONAL DE GRAN CAPACIDAD

Apertura de todo tipo
de latas cilíndricas
o rectangulares,
incluso abolladas,
de 5 a 27 cm de altura



Desmontaje
y limpieza
fácil

Productividad:
400-500 pzas/h

Desplazamiento vertical
**asistido mediante
resorte neumático**



LOUIS TELLIER



Made in
France



Abrelatas eléctrico profesional para más de 800 cubiertos.

3 modelos disponibles.

Fabricación de materiales inoxidables.

Por razones de dureza, la rueda de ajuste está realizada en acero templado y tratado contra la oxidación.

ABRELATAS DE SEGURIDAD SIN BORDES CORTANTES



LOUIS TELLIER



Sin esfuerzos

Abre las latas de conservas con **total seguridad** : bordes netos y no cortantes

Sin limaduras

Sistema patentado

El aparato **nunca está en contacto** con el interior de la lata

Higiene, seguridad y robustez



Abre latas redondas de cualquier tamaño cortando el engastado exterior : los bordes son limpios, no hay riesgo de cortarse. Es posible reutilizar el sombrero de la lata para proteger su contenido del polvo y de las salpicaduras (la tapa ya no permite una conservación hermética).

Su peso le permite ser estable sobre la lata y asegurar un guiado óptimo.

El diseño del cabezal limita las piezas de desgaste, así como los intersticios donde podría acumularse la suciedad.

Disponible con una placa abrazadera o una placa para atornillar.

Apto para lavado en lavavajillas.

Sistema patentado

Made in France

ABRELATAS SEGURIDAD - FIJACIÓN TORNILLOS

Sistema patentado. Abra cajas redondas de todos los tamaños (por ejemplo, 5/1) doblando el borde exterior. Los bordes quedan sin riesgo de corte y es posible reutilizar la tapa de la lata para proteger su contenido. Tenga cuidado, una vez que la lata está abierta, el cierre ya no es hermético.

Acero inoxidable



Réf.					
OBSXP55	28	12,2	77,5	4,8	Fijación tornillos

ABRELATAS SEGURIDAD - SOPORTE BRIDA

Sistema patentado. Abra latas redondas de todos los tamaños (por ejemplo, 5/1) doblando el borde exterior. Los bordes son afilados, sin riesgo de corte, y es posible reutilizar la tapa de la caja para proteger su contenido. Tenga cuidado, una vez que la caja está abierta, el cierre ya no es hermético.

Acero inoxidable



Réf.					
OBSXV55	28	12,2	77,5	4,8	SopORTE brida

ABRELATAS MANUAL - NF HIGIENE ALIMENTARIA - TODO INOX. - FIJACIÓN TORNILLOS

Barra 55 cm, base 22 x 12 cm. Vástago íntegro, cabezal monobloque, desmontable sin herramientas. Lavavajillas. Sistema patentado. Todas las formas de latas.

Acero inoxidable



Réf.			
OXP55	78	3,2	Fijación tornillos

ABRELATAS MANUAL - NF HIGIENE ALIMENTARIA - TODO INOX. - SOPORTE BRIDA

Barra 55 cm, base 22 x 12 cm. Vástago íntegro, cabezal monobloque, desmontable sin herramientas. Lavavajillas. Sistema patentado. Todas las formas de latas.

Acero inoxidable



Réf.			
OXV55	78	4,2	SopORTE brida

ABRELATAS INOX. CON CABEZA DE RESINA - FIJACIÓN TORNILLOS

Barra 55 cm, base 22 x 12 cm. Lavavajillas. Sistema patentado. Todas las formas de latas.

Acero inoxidable, material compuesto



Réf.			
OX5P55	79	2,5	Fijación tornillos

ABRELATAS INOX. CON CABEZA DE RESINA - SOPORTE BRIDA

Barra 55 cm, base 22 x 12 cm. Lavavajillas. Sistema patentado. Todas las formas de latas.

Acero inoxidable, material compuesto



Réf.			
OX5V55	79	2,8	SopORTE brida

ABRELATAS ECONÓMICO - FIJACIÓN TORNILLOS

Barra 55 cm, base 22 x 12 cm. Sistema patentado. Todas las formas de latas.

Material compuesto, acero niquelado, base de acero pintado con epoxi



Réf.
O5P55 78 2,8 Fijación tornillos

ABRELATAS ECONÓMICO - SOPORTE BRIDA

Barra 55 cm, base 22 x 12 cm. Sistema patentado. Todas las formas de latas.

Material compuesto, acero niquelado, base de acero pintado con epoxi



Réf.
O5V55 78 2,8 Soporte brida

ABRELATAS MANUAL PROFESIONAL LT ORIGINAL - FIJACIÓN TORNILLOS

Barra 55 cm, base 22 x 12 cm. Sistema patentado. Todas las formas de latas.

Acero niquelado, base de acero pintado con epoxi



Réf.
O2P55 77 3 Fijación tornillos

ABRELATAS MANUAL PROFESIONAL LT ORIGINAL - SOPORTE BRIDA

Barra 55 cm, base 22 x 12 cm. Sistema patentado. Todas las formas de latas.

Acero niquelado, base de acero pintado con epoxi



Réf.
O2V55 77 3,35 Soporte brida

ABRELATAS MANUAL PROFESIONAL LT - FIJACIÓN TORNILLOS

Barra 40 cm, base 18 x 8 cm. Sistema patentado. Todas las formas de latas.

Acero niquelado, base de acero pintado con epoxi



Réf.
O3P40 62 2 Fijación tornillos

ABRELATAS MANUAL PROFESIONAL LT - SOPORTE BRIDA

Barra 40 cm, base 18 x 8 cm. Sistema patentado. Todas las formas de latas.

Acero niquelado, base de acero pintado con epoxi



Réf.
O3V40 62 2 Soporte brida

KIT DE REPUESTO PARA ABRELATAS MANUAL O2/OX

Cuchilla, rueda, anillo y herramienta de desmontaje

Acero inoxidable, acero templado, rilsan



Réf.		
O2895	0,15	OXV55 / OXP55 / O2V55 / O2P55

KIT DE REPUESTO PARA ABRELATAS MANUAL O3/O5/OX5

Cuchilla, rueda, anillo y herramienta de desmontaje

Acero inoxidable, acero templado, rilsan

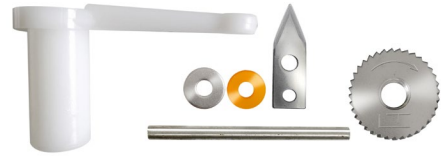

Réf.		
O3895	0,15	OX5V55 / OX5P55 / O5V55 / O5P55 / O3V40 / O3P40

LOTE DE 2 MOLETAS PARA OXP55/OXV55

Fácil desmontaje : bloquee el pomo con la herramienta, desenrosque la empuñadura girando en sentido antihorario para extraer el pomo.

Herramienta de desmontaje

Acero templado

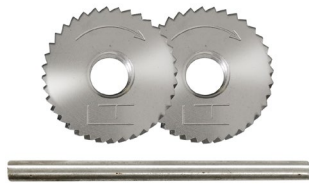

Réf.		
O2820-2	0,36	0,1

LOTE DE 5 ARANDELAS DE RILSAN PARA O2/OX

Rilsan



Réf.		
O2870-5	6	1,25
		OXV55 / OXP55 / O2V55 / O2P55

LOTE DE 5 ARANDELAS DE RILSAN PARA O3/O5/OX5

Rilsan



Réf.		
O3870-5	4	1
		OX5V55 / OX5P55 / O5V55 / O5P55 / O3V40 / O3P40

ABRELATAS TITAN SEMI-PROFESIONAL

Cuchillas y ruletas de recambio disponibles. Adaptado para latas grandes. La cuchilla en punta se introduce automáticamente en la lata de conservas.

Abrebotellas

Acero templado estañado, hoja de acero niquelado, mango de madera de haya



Réf.				
N4041	8	6	10	0,2

ABRELATAS PRIMER PRECIO

Lote de 10.

Abrebotellas

Hoja de acero templado, mango de acero inoxidable



Ref.				
N4056	9,5	2	2	0,35

ABRELATAS MANUAL DE SEGURIDAD «PALM»

Corte limpio, sin limadura: la hoja no toca el contenido de la lata. Asa ergonómica y uso fácil. Seguridad: apertura limpia sin dejar borde cortante. Corte preciso y sobre el borde exterior del cuerpo de la lata.

ABS, hoja de acero

LOUIS TELLIER

Ref.				
N4057	9,5	7,5	5	0,135

PRENSA

¡Un 80% menos de volumen de residuos! Adaptado a las latas cilíndricas 5 x 1 y 3 x 1. Para comprimir latas.

Acero inoxidable

LOUIS TELLIER

Ref.				
N8019	28,5	40,5	112	20,09

ABRELATAS ECONÓMICO - SOPORTE BRIDA



Abre latas redondas de cualquier tamaño cortando el engastado exterior : los bordes son limpios, no hay riesgo de cortarse. Es posible reutilizar el sombrero de la lata para proteger su contenido del polvo y de las salpicaduras (la tapa ya no permite una conservación hermética).

La fijación por abrazadera garantiza una estabilidad óptima.

Su peso le permite ser estable sobre la lata y asegurar un guiado óptimo.

La manivela garantiza la apertura de cajas sin esfuerzo y sin limaduras.

Sistema patentado.

Made in France.

BALANZA ELECTRÓNICA PROFESSIONAL COMPACTA



LOUIS TELLIER



Totalmente de acero inoxidable

IP67 : **totalmente protegida**
contra el polvo y la inmersión temporal
(hasta 1 m y durante 30 minutos)



Compacta :
dimensiones reducidas

Unidades de medida :
kg, g, lb, oz

Diseñada para todas las aplicaciones
industriales y **alimentarias**

Dos modelos disponibles :

1. Pesaje máx. 5 kg - precisión de 0,5
2. Pesaje máx. 10 kg (mín. 20 g) - precisión de 1 g.

Creadas para cualquier aplicación industrial (particularmente agroalimentaria),
en medio difícil y húmedo (salas blancas refrigeradas, colectividades, amasaderos, etc.).

BALANZA ELECTRÓNICA PROFESIONAL IP53

IP53. Nivel integrado. Patas ajustables en altura. Unidades de medida: kg u oz. Función tara. Alarma de peso programable. Recalibrado fácil. Testigo de desgaste de pilas.

⚡ Funciona con adaptador de red tipo DC 6V 100 Ma

📦 ABS, bandeja amovible de acero inoxidable



BEST SELLER

LOUIS TELLIER IP53

Réf.	↔	↗	↑	📦	⚖️	⚡
N3671	31	30	11,5	3,1	Max 12 kg / Min 20 g	1 g
N3672	31	30	11,5	3,1	Max 30 kg / Min 40 g	2 g
N3673	31	30	11,5	3,1	Max 50 kg / Min 100 g	5 g

BALANZA ELECTRONICA IMPERMEABLE PROFESIONAL IP65

IP65. Circuito A/D Electron resistente a un entorno húmedo. Unidades de medida: kg, lb. Función tara. Recalibrado fácil. Nivel integrado. Patas ajustables en altura.

⚡ Adaptador de corriente N3697-A

📦 ABS, acero inoxidable, PC



LOUIS TELLIER IP65

Réf.	↔	↗	↑	📦	⚖️	⚡
N3697	24	29	13	3,2	Max 15 kg / Min 20 g	2 g

BALANZA ELECTRÓNICA PROFESIONAL COMPACTA Y IMPERMEABLE IP67

IP67. Indicaciones de batería baja y sobrecarga. Protegido contra los efectos de la inmersión temporal (hasta 1 m) y durante 30 minutos. Unidades de medida: kg, g, lb, oz

📦 Acero inoxidable



LOUIS TELLIER IP67

Réf.	↔	↗	↑	⚖️	⚡
N3681	20	21,5	7	Max 5 kg	0,5 g
N3682	20	21,5	7	Max 10 kg / Min 20 g	1 g

BALANZA ELECTRÓNICA PROFESIONAL CON COLUMNA IP51

IP51. Nivel integrado. Patas ajustables en altura. Autonomía de la batería: 100 horas. Pantalla orientable. Función tara. Alarma de peso programable. Recalibrado fácil.

⚡ Indicador de nivel de batería

📦 ABS, aluminio, bandeja amovible de acero inoxidable



LOUIS TELLIER IP51

Réf.	↔	↗	↑	📦	⚖️	⚡
N3684	57	32	61	9,7	Max 60 kg / Min 200 g	10 g
N3685	57	32	61	9,7	Max 150 kg / Min 400 g	20 g
N3686	67,5	42	88	13,5	Max 300 kg / Min 1kg	50 g

BALANZA ELECTRÓNICA PROFESIONAL IP53

IP53. Unidades de medida: kg, lb, oz, piezas. Funciones: tara y recuento de piezas. Recalibrado fácil.

⚡ Indicador de nivel de batería

📦 ABS, bandeja amovible de acero inoxidable 22 x 16,5 cm

⚡ DC 6 V 100 mA



BEST SELLER

LOUIS TELLIER IP53

Réf.	↔	↗	↑	📦	⚖️	⚡
N3693	24	24	7,5	1,9	Max 5 kg / Min 10 g	0,5 g
N3694	24	24	7,5	2,13	Max 10 kg / Min 20 g	1 g

BALANZA DE PRECISIÓN

Tapa de protección. Ideal para la cocina molecular. Táctil. Unidades de medida: g y oz.

⚡ Indicador de nivel de batería

📦 ABS



Réf.	↔	↗	↑	📦	⚖️	⚡
N3665	11,5	7,5	2,5	0,105	200 g	0,01 g

ADAPTADOR

Adaptador opcional, no incluido con las balanzas.

- Cable : 1,5 m
- Cobre y ABS



LOUIS TELLIER

Réf.	↔	↗	⏊	📦	⚖️
N3670-A	16,5	4	7	0,642	N3670 / N3671 / N3672 / N3673
N3693-A	159	6	3,5	0,5	N3693 / N3694
N3697-A				0,67	N3697

BALANZA MECÁNICA CON CUBO INOX.

- Cuenca extraíble de acero inoxidable de Ø20 cm
- Acero inoxidable, esfera de plástico



Réf.	∅	⏊	📦	⚖️	⚡
N3690	20	25	1,5	Max 3 kg	10 g
N3691	20	25	1,5	Max 5 kg	20 g

BALANZA MECÁNICA CON BANDEJA

- Bandeja de acero inoxidable 25 x 25 cm
- Acero inoxidable, esfera de plástico



Réf.	↔	↗	⏊	📦	⚖️	⚡
N3692	25	26	26	2,5	Max 20 kg	100 g

BALANZA ELECTRÓNICA USO DOMÉSTICO

- Cuenca extraíble. Unidades de medida: g u oz. Función tara.
- Indicador de nivel de batería
- ABS



Réf.	↔	↗	⏊	📦	⚖️	⚡
N3695	21,5	15	4	0,28	1 kg	0,5 g
N3696	21,5	15	4	0,28	3 kg	1 g

BALANZA ELECTRÓNICA PROFESIONAL DE COLUMNA IP51



LOUIS TELLIER
SEEN NE REMPLACE LE FATI MARK



Pantalla **orientable**



Alarma de peso **programable**

Función **tara**

Bandeja extraíble de **inox**.

Altura de las patas **regulable**

Tres modelos disponibles:

1. Pesaje máx. 60 kg (mín. 200 g) - precisión de 10 g (ref. N3684)
2. Pesaje máx. 150 kg (mín. 400 g) - precisión de 20 g (ref. N3685)
3. Pesaje máx. 300 kg (mín. 1 kg) - precisión de 50 g (ref. N3686)

Ideal para cualquier aplicación industrial (especialmente en el sector alimentario) gracias a su precisión de medición y a su gran solidez.

TERMÓMETRO INFRARROJO CON LÁSER



PREPARACIÓN CULINARIA

Ideal para **cámara fría,**
camión refrigerado

Distancia de lectura
hasta **9 m**

Intervalo de temperatura :
-60°C +500°C

Tiempo de respuesta :
1 segundo

Precisión con una
**aproximación de
0,1°C**

ABS

Se vende con funda y piloto de desgaste de las pilas (2 x AAA 1,5 V incluidas).

TERMÓMETRO INFRARROJOS CON MIRA LÁSER

Control de las temperaturas de cámaras frigoríficas, camiones frigoríficos... Lectura láser: distancia de hasta 9 m. Tiempo de respuesta: 1 segundo.

Cubrir. Indicador de nivel de batería.

ABS

-60° a +500°C / -76° a 932°F

0,10°C



LOUIS TELLIER

Ref.					
N3124	17,5	3,9	7,2	0,18	Sin certificado de calibración
N3124C	17,5	3,9	7,2	0,18	Con certificado de calibración

TERMÓMETRO HACCP INFRARROJO

Sonda retráctil: -55°C +330°C (-67°F +626°F). Lectura IR: distancia hasta a 1,60 m. IP54. Testigos luminosos HACCP conexiones calientes y frías. Función de escaneado de temperaturas mín. y máx.

Indicador de nivel de batería

ABS, acero inoxidable

°C / °F. IR : -55°C a +250°C / -67°F a +482°F

0,2°C / 0,5 °F



LOUIS TELLIER

Ref.				
N3127	16	3,5	2	0,1

TERMÓMETRO ELECTRÓNICO

Sonda 12 cm. Sonda replegable.

Correa para la muñeca. Indicador de nivel de batería.

ABS, acero inoxidable

-50°C a +300°C / -58°F a +572°F

0,1°C / 0,1° F



LOUIS TELLIER

Ref.				
N3122	15,5	4,5	2	0,08

TERMÓMETRO DIGITAL CON Sonda ROTATIVA

Acero inoxidable, ABS, PVC

-50°C a +300°C / -58°F a +572°F



Ref.				
UTD01	16	5	1,8	0,7

MINI TERMÓMETRO DIGITAL ELECTRÓNICO

Sonda: 13 cm. Función memoria de la última temperatura medida.

Funda, clip para bolígrafo

PP, acero inoxidable

°C / °F : -50°C a +150°C / -58°F a +302°F

0,1°C / 0,1° F



Ref.				
N3119	14,5	5,5	4	0,04

TERMÓMETRO DE COCINA CON CARCASA

Cable de 1,50 m. Sonda de 12,5 cm con mango y capuchón. Funciones: Memorización de la última temperatura medida, Mín. y Máx.

Parte trasera magnética

ABS, acero inoxidable

°C / °F : -40°C a +300°C / -40°F a +572°F

0,1°C / 0,1° F



Ref.				
N3123	18	8	2	0,09

TERMÓMETRO DIGITAL ELECTRÓNICO

Sonda 12 cm. Función memoria de la última temperatura medida.

Estuche protector

ABS, sonda de acero inoxidable

°C / °F. : -50°C a +300°C / -58°F a +572°F

0,1°C / 0,1° F



LT
LOUIS TELLIER

Ref.				
N3110	22,5	2,5	1,5	0,04

TERMÓMETRO ELECTRÓNICO SONDA «ESTILOGRÁFICA»

Para un perfecto control y dominio de la temperatura. Sonda : 13 cm. Impermeable.

Funda, clip para bolígrafo para bolsillos. Indicador de nivel de batería.

Vaina de PP, sonda de acero inoxidable

°C / °F. : -50°C a +300°C / -58°F a +572°F

0,1°C / 0,1° F



LT
LOUIS TELLIER

Ref.				
N3118	21	2	2	0,03

ESPUMA AUTOADHESIVA

Rollo: 5m. Para termómetro al vacío. Para prevenir una fuga de aire durante la perforación de las bolsas.

Espuma de PA



Ref.					
N8201	20	20	1	0,34	N8200

DENSÍMETRO PESA JARABE

2 escalas: g/ml y °Bé, 1.100-1.400g/ml, 15-40°Bé. Mide la densidad de azúcar en un almíbar.

Vidrio, papel, acero y parafina



LT
LOUIS TELLIER

Ref.				
N3109	12	1,5	12,5	0,2

PROBADOR DE SALINIDAD Y TERMÓMETRO

Medida de sal: 0% to 5%. Para medir el contenido en sal en los alimentos o líquidos.

Punta de cuchara. Termómetro.

ABS, PP

0°C a +100°C / +32°F a +212°F

0.001



LT
LOUIS TELLIER

Ref.				
N3100	23	5	5	0,06

TERMÓMETRO PARA EMBUTIDOS

Para un perfecto control y dominio de la temperatura.

Funda de protección alimentaria esterilizable

Vidrio, vaina de PP

-10°C a +120°C / 14°F a +248°F

1°C



LT
LOUIS TELLIER

Ref.				
N3111	33	3,5	3,5	2,13

TERMÓMETRO PARA CONFITERO

Para la cocción de azúcar (Boulé, granizo de azúcar o caramelo) y mermeladas.

Envoltura alimentaria de PP esterilizable

Vidrio

+80°C a +200°C / +176°F a +392°F

1°C



Réf.					
N3113	33	3,3	3,5	0,65	Funda de PP
N3114	30,3	2,7	2,7	0,1	Funda inox.

TERMÓMETRO PARA PANADERO

Para un perfecto control y dominio de la temperatura.

Envoltura alimentaria de PP esterilizable

Vidrio, vaina de PP

-10°C a +60°C / +14°F a +140°F

1°C



Réf.			
N3115	35,5	2,4	0,61

TERMÓMETRO CON SONDA

Para jamón, foie gras, chocolate.

Vidrio

-30°C a +100°C / -22°F a +212°F

1°C



Réf.		
N3117	25,5	0,16

TERMÓMETRO PARA CONGELADOR

Para un perfecto control y dominio de la temperatura.

Envoltura alimentaria de PP esterilizable

Vidrio, vaina de PP

-50°C a +50°C / -58°F a +122°F

1°C



Réf.				
N3116	33	3,5	3,5	0,05

TERMÓMETRO CONGELADOR - PRIMER PRECIO

Para un perfecto control y dominio de la temperatura.

Gancho

Vaina de PP

-40°C a +25°C / -40°F a +77°F

1°C



Réf.					
N3120	14	1,5	1	0,01	Con funda

TERMÓMETRO CONGELADOR REDONDO - PRIMER PRECIO

Para un perfecto control y dominio de la temperatura.

Gancho

PS, ABS, aluminio y latón

-30°C a +50°C / -22°F a +122°F

1 min.



Réf.					
N3121	8	6,5	2	0,1	Con esfera

TEMPORIZADOR DIGITAL 3 FUNCIONES

ABS



Réf.				
UMD01	7	5,5	7	0,04

TEMPORIZADOR MECÁNICO 60 MINUTOS

ABS



Réf.				
UMM01	6	6	3	0,07



26.0°C



COCCIÓN/MANTENIMIENTO TEMPERATURA

COCINA

- Baño maría y cocina
- Accesorios

119

119

121



BAÑO MARÍA COCCIÓN AL VACÍO

SOUSVIDE SUPREME™

SousVide
SUPREME™

Una cocción **sana** y **sabrosa** que preserva todas las propiedades organolépticas, nutricionales y las texturas de los alimentos

Sin riesgo de sobrecocción

Una cocción **sin estrés** y **sin vigilancia** gracias al temporizador

Ajuste exacto de la temperatura a con **una precisión de 0,5°C.**



Una cocción uniforme, precisa y controlada gracias al **regulador** de temperatura proporcional integral diferencial (PID) integrado

Un funcionamiento **sencillo** : preparar, sazonar, sellar, cocer a fuego lento y servir

Carnes, aves, pescados, frutas, verduras, huevos, sopas, yogur, alcoholes infusionados, postres, productos ecológicos, etc. : en el baño maría al vacío Supreme™. Pueden cocerse todo tipo de alimentos. Permite cocinar delicadamente los alimentos sellados en bolsas herméticas engastadas al vacío a temperaturas suaves de 30°C a 100°C.

El tiempo de cocción varía de 20 minutos (pescados magros) a 72 horas (caza). La temperatura elegida se mantiene durante todo el tiempo y después de la cocción : los alimentos pueden quedarse en el baño maría más tiempo del necesario sin exceso de cocción.

El regulador de temperatura proporcional integral diferencial (PID) mantiene el agua a una temperatura constante durante la cocción y garantiza una distribución homogénea de la temperatura por convección térmica. Los alimentos se cuecen uniformemente por ambos lados, se resalta su sabor y se mantienen tiernos al final de la cocción.

El baño maría funciona :

- Sin bomba externa
- Sin ruido
- Sin riesgo de evaporación

BAÑO MARÍA COCCIÓN AL VACÍO SOUSVIDE SUPREME™ - NEGRO

Para 8 a 12 partes de 115 g. Temperatura homogénea controlada y precisa (0,5°C de diferencia máxima en el baño maría). Control permanente de la temperatura del baño en la pantalla LCD. Aumento de la temperatura en 20 minutos (de 20°C a 65°C). Cocción al vacío + calentamiento. Silencioso. Sin evaporación.

- 8,7 L - 2,4 gallons
- Temporizador. Rejilla de soporte para bolsas de vacío.
- Tanque de chapa esmaltada, externo de acero revestido, tapa de aluminio
- 50/60 Hz - 462/550 W - 220/240 V
- +30°C à +100°C
- 0,1°C / 0,1°F



SousVide SUPREME™

Réf.				
N8110	33	28	25	4,1

BOLSAS SOUSVIDE SUPREME™

Bolsas gofradas con una malla especialmente diseñada para evacuar mejor el aire durante la aspiración y para crear una junta estanca durante el sellado. Adaptadas para cocinar al vacío y conservar. Baño maría, microondas, frigorífico, congelador.

- Películas bicapa de PA/PE, espesor 85 micras
- 20°C à +90°C



SousVide SUPREME™

Réf.						
NVS010	30,5	20,3	0,31	0,314	25 bolsas de 0,95 L	NVS300
NVS020	40,6	27,9	0,55	0,539	25 bolsas de 3,8 L	NVS300
NVS030	61	27,9	0,73	0,729	2 rodillos de 6 m (para cortar y sellar)	NVS300

COCEDOR DE VAPOR ELÉCTRICO

Para 10 kg de verduras u 8 pollos. Termostato regulable. Aumento rápido de la temperatura. Cocina sana y rápida. Transportable: ideal para mercados y catering.

- 15 L
- Acero inoxidable
- 2000 W - 230 V
- +70°C à +80°C



Réf.			
N8090	38	46	7

COCEDOR DE HUEVOS ELÉCTRICO GN1/3

Con capacidad para 10 cestas. Termostato de regulación, termostato de seguridad en caso de recalentamiento o de que falte agua. Ideal para bufés de desayuno. Los huevos se preparan en el punto de cocción deseado.

- 6 cestas numeradas de acero inoxidable. Tapa.
- Acero inoxidable
- 50/60 Hz - 1200 W - 220/240 V
- 0°C à +90°C



Réf.				
N8093	41	24	31	5

CANASTA DE HUEVOS

- Acero inoxidable



Réf.				
N8093-P	5	14	16	N8093

COCEDOR DE ARROZ ELÉCTRICO

2 funciones: cocción y mantenimiento en caliente. Activación automática del modo de mantenimiento en caliente al final de la cocción. Cuba graduada. Termostato de seguridad en caso de recalentamiento o de que falte agua. Gran capacidad y ligereza.

- 21 L - 10 kg
- Cuchara medidora de arroz
- Tanque de aluminio revestido antiadherente
- 50 Hz - 3000 W - 220 V



LT
LOUIS TELLIER

Réf.			
N8094	50	52	10

COCEDOR DE ARROZ ELÉCTRICO COMPACTO

Bloqueo de la tapadera. Compacta. 2 funciones: cocción y mantenimiento en caliente. Activación automática del modo de mantenimiento en caliente al final de la cocción.

13 L - 6 kg

Espátula y medida

Acero inoxidable, tanque de aluminio revestido antiadherente

50 Hz - 1950 W - 220 V



Réf.				
N8900	45	38	34	10,4

MARMITA DE SOPA BAÑO MARIA NEGRA

Semiapertura de la tapadera: servicio práctico. Para mantener calientes sopas, vino caliente... Ideal para bufés. Temperatura regulable (termostato graduado en 12 posiciones).

Útil : 8L - Total : 10 L .

Almohadillas antideslizantes

Tanque amovible de acero inoxidable

50 Hz - 400 W - 230 V

Max +98°C / 208°F

LOUIS TELLIER

Réf.				
N8060	34	38	4,5	Negra

DISPENSADOR BAÑO-MARIA PARA SALSAS CALIENTES

Porción de salsa 40 ml (ajustable). Temperatura regulable. Mantiene calientes las salsas y el chocolate. Ideal para crepes, profiteroles...

3 L

Cierre de tapa por resortes

Tubo, bomba y tanque de acero inoxidable



Réf.			
NDS301	18	3,87	3,87

PALA PARA PATATAS FRITAS

Fácil manejo de las patatas fritas. Recoger y esparra las patatas fritas con la lengüeta trasera. Se inserta perfectamente en las cajas de cartón y las bolsitas (8.5 cm de ancho y 3.5 cm de altura).

Acero inoxidable



LOUIS TELLIER

Réf.	↔	↗	⊥	📦	🔍
N4043-ID	20	19	6,5	0,33	Para diestros
N4043-IDG	20	19	6,5	0,33	Ambidextro

MOLDE NIDO

Ø 10 cm. Calidad profesional.

Acero inoxidable



LOUIS TELLIER

Réf.	∅	⊥	📦
NC019	10	11	0,3

MINI CESTA DE FREIR RECTANGULAR

Servicio a la moda para patatas fritas, buñuelos, tempuras. Hilo doble robusto y bien acabado (sin rebabas).

Acero inoxidable



Réf.	↔	↗	⊥	📦	🔍
NC1018160	10	8,5	6	0,15	1 ración

ESPÁTULA PARA PLANCHA

Hoja: 15 x 10 cm. Mango sobremoldeado antideslizante x 13 cm. Apto para lavavajillas. Paleta acodada rígida gruesa (2 mm), bordes biselados.

Acero inoxidable templado, PP



LOUIS TELLIER

Réf.	↔	↗	⊥	📦
N5400	30	10	9	0,31

CESTA PARA FREIR

Asas fijas.

Acero inoxidable



Réf.	∅	⊥	📦
NC1043960	39	13	0,65

ESPÁTULA T REDONDA PARA CREPES - HAYA

Extender una masa fina y homogénea. Calidad profesional.

Madera de haya

BEST SELLER

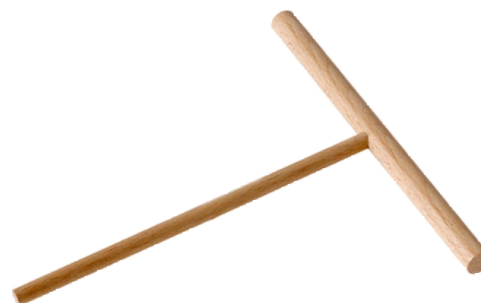

Réf.	↔	↗	⊥	📦
NRC01-1	18	18	1	0,02

ESPÁTULA T REDONDA PARA CREPES INOX

Extender una masa fina y homogénea. Calidad profesional.

Acero inoxidable



Réf.				
NRC01X	18,5	18	1,5	0,01

ESPÁTULA T REDONDA PARA CREPES

Extender una masa fina y homogénea. Calidad profesional.

Madera de haya



Réf.				
NRC02-1	24	18	3	0,03

PALA PARA GIRAR LOS CREPES

Madera de haya



Réf.				
NRC03-1	40	4,5	0,5	0,04

MANOPLA DE PROTECCIÓN PROFESIONAL

Talla estandar: protección de las manos y de las muñeca. Color negra. Ambidiestro. Protección hasta 250°C. Hermético al agua y al aceite muy caliente.

Silicona THS



Réf.					
N3087R	29	13	3	0,23	Corta
N3087RL	43	16	3	0,36	Larga

GUANTE RESISTENTE AL CALOR AMBIDEXTRO

Guante de trabajo, EPI, calidad profesional.

Fibras aramidas

LOUIS TELLIER

Réf.					
GAN13	31	14	27,5	0,09	Talla única. Color rojo y negro

ARROCERA ELÉCTRICA



LOUIS TELLIER
SEEN NE REMPLACE LE FAYE MARIE

2 funciones:
cocción y mantenimiento
en caliente

Cuba **graduada**



Termostato de seguridad
en caso de recalentamiento
o de que falte agua

Gran capacidad:
hasta **10 kg** de arroz

Arrocera eléctrica de gran capacidad.

Activación automática del modo de mantenimiento en caliente al final de la cocción.



CAFETERÍA/BAR/RECEPCIÓN

ZUMOS	127
ACCESORIOS DE BAR	129
DESAYUNO/RECEPCIÓN	133

EXPRIMIDOR DE GRANADAS Y CÍTRICOS



LOUIS TELLIER
BIEN NE REMPLACE LE FATI MARI



Presión máxima **sin esfuerzo** :
gracias a la palanca lateral doble
vuelta sobre muelle

**Aluminio,
acero cromado
y acero inoxidable**

Empujador y rejilla **adaptados**
a las granadas, naranjas
y pomelos

Asa **antideslizante**

Recuperador de gotas de acero
inoxidable **rotativo y amovible**

Estable :
gracias a su zócalo **antideslizante**
de acero cromado

Modelo de mostrador con su elegante diseño.

La granada es conocida por sus beneficios antioxidantes : ¡los zumos detox le están esperando!
La rejilla des montable, el empujador y el recuperador de gotas son de acero inoxidable.

LICUADORA ELÉCTRICA ELÉCTRICA

Para extraer los jugos de las verduras / frutas (batidos, cócteles ...). Motor refrigerado por aire, calificado para un funcionamiento continuo. Expulsión automática de orujo y pulpa en una bandeja colectora de manejo rápido. Muy estable con sus 4 ventosas montadas sobre silent-blocks.

 Velocidad: 6300 rpm regulada automáticamente. 1 posición de turbo.

 Acero inoxidable

 Zanahorias = 60 kg / h

 - 450 W -



Réf.				
CEN426	3,1	1,9	3,8	3,96

EXPRIMIDOR DE GRANADAS Y CÍTRICOS CON PALANCA

Pulsador y rejilla adaptados a las granadas, naranjas y pomelos. Palanca lateral de doble vuelta: máxima presión. Asa antideslizante.

 Recipiente antigoteo

 Aluminio, acero cromado y acero inoxidable



Réf.				
N4097	27	19,5	50	6

EXPRIMIDOR DE BARRA CON PALANCA

Altura con el mango alzado: 83,5 cm. Superprofesional. Potente palanca frontal. Cómoda asa antideslizante.

 Tabla de cortar con almohadillas

 Aluminio, acero cromado y ABS







Réf.				
N4098	40	25	50,5	6,9

EXPRIMIDOR DE LIMÓN MANUAL

Con cuenco y boca de vertido. Para limones, limones verdes y naranjas.

 Acero inoxidable



Réf.				
N4105	17	13	12	0,29

PRENSA 1/2 RODAJA DE LIMÓN

Exprime limpiamente el limón al instante. Servicio cuidado y limpio. 1 para 2 personas. Para 1/2 rodajas de limón de 1 cm de espesor.

 Copoliéster



Réf.					
N4120	12	3	6	0,05	Por unidad, en bolsa de polietileno

PRENSA 1/2 RODAJA DE LIMÓN - DISPLAY

Exprime limpiamente el limón al instante. Servicio cuidado y limpio. 1 para 2 personas. Para 1/2 rodajas de limón de 1 cm de espesor.

 Copoliéster



Réf.					
N4120-24P	12	2,5	5	1,6	El display de 24 (12 cajas de 2)

PRENSA LIMÓNES MANUAL

 Acero inoxidable

Réf.				
N4107	16	4	4	0,09

BILLAS VERTEDORA

Para alcohol seco. Fácil reconocimiento de la dosificación gracias a los colores, incluso en el mundo de la noche.

- 2 cl
- Plástico



Réf.	↔	↙	⊥	🍷	🔍
DP212-J	9,5	4	0,02	Amarilla - 2 cl	
DP213-V	9,5	4	0,02	Verde - 3 cl	
DP214-B	9,5	4	0,02	Azul - 4 cl	
DP215	9,5	4	0,02	Roja - 5 cl	

PICO VERTEDOR CON SALIDA ESTRECHA

Aderezo y decoración en el plato

- Metal



Réf.	↔	↙	⊥	🍷	🔍
DO956	11	3	0,15		

MEDIDOR LICOR DOBLE

Dosis de 1, 2, 3 y 4 cl. Graduación de cl. en cl.

- 2-4 cl
- Acero inoxidable



Réf.	↔	↙	⊥	🍷	🔍
N4135	4,5	4,5	7	0,04	

SACACORCHO SOMMELIER

Serigrafía posible.

- Mecanismo de acero inoxidable, mango de metal con inserto de plástico, malla de metal revestimiento de teflón.



Réf.	↔	↙	⊥	🍷	🔍
TBCOU02-R	12	20	1,4	0,07	Burdeos
TBCOU01-N	12	20	1,4	0,07	Negro

SACACORCHOS Y ABRIDOR SUMILLER - 2 ABRIDORES DE BOTELLAS

Multifunción: sacacorchos, descapsulador, cortacápsulas.

- Acero cromado



Réf.	↔	↙	⊥	🍷	🔍
N4312	14	3,5	1	0,07	2 abridores

SACACORCHOS Y ABRIDOR SUMILLER - 1 ABRIDOR DE BOTELLAS

Multifunción: sacacorchos, descapsulador, cortacápsulas.

- Acero cromado



Réf.	↔	↙	⊥	🍷	🔍
N4313	11	2,5	1	0,05	1 abridor

SACACORCHO BODEGUERO EN 2 GOLPES

Doble palanca con 2 puntos de apoyo. Reducción del esfuerzo. Extracción del corcho en 2 tiempos con un simple movimiento de presión.

Vástago recubierto de teflón, cortador de cápsulas dentado

acero inoxidable, ABS



Réf.					
N4319	12,7	3	1,6	0,03	Negro

ABRIDOR DE CHAPAS CON CAJA DE RECUPERACIÓN EN INOX

Caja de recogida integrada. Fijación a la pared.

Acero inoxidable



Réf.				
N4055X	10	6	30,5	0,38

COCKTAIL MASTER

Realiza sus cocteles de varios pisos de colores: ¡Su Café Irlandés tendrá éxito! Ø min. - max. del vaso: 5 - 10,5 cm.

Cromo



Réf.					
DO251	12	12	27	0,5	Cromado

PACK DE 2 LLAVEROS BATIDOR DE COCINA

Acero niquelado



Réf.				
N3082	13	6	1,5	0,18

TAPÓN DE CHAMPÁN

Estanqueidad perfecta. Bloqueo eficaz. Conserva el gas del champán.

Acero cromado, TPR



Réf.				
N4054	3	5,5	0,07	N4054

SIFÓN AGUA DE SELTZ

Tanque de inox. Para producir 1 litro de agua con gas.

1 L

Tanque de acero inoxidable



Réf.						
N4075X	18,5	9	32,5	0,85	Sifón	
N4074				0,3	Recargas CO2	N4075X

EMBUDO CON FILTRO

Filtro extraíble. Para servir el vino en jarra. Filtra los sedimentos. Capacidad : 400 ml.

Acero inoxidable



Réf.				
N3740	15	13	13	0,16

CUCHARA PARA CÓCTEL

Con un extremo de cuchara y otro de tenedor.

Acero inoxidable



Réf.				
N4134	31,5	2,5	0,4	0,03

PISÓN DE HAYA PARA COCTEL

Madera de haya



Réf.				
N4136	20	3,5	0,06	De madera

PISÓN DE HAYA PARA COCTEL BRASILEÑOS

Madera de haya



Réf.					
N4140	21,5	3,2	3	0,08	Brasileño

SOPORTE BLANCO PARA VASO

Para vaso con pie <1,2 cm. Lote de 20. Para recepciones y aperitivos de pie. Mantiene la copa en el borde del plato.

PP



Réf.				
N4142-20	14	10	5	0,16

PINZA PARA TÉ

Infusión individual directamente en una taza

Abrazadera

Acero inoxidable



Réf.			
N9200	4	4,5	0,04

BOLA PARA TÉ Y ESPECIAS

Para aportar sabor sin que las hierbas y especias se esparzan por el plato.

Acero inoxidable



Réf.				
N9201	4,5	3,5	0,03	4,5 cm
N9202	6,5	5	0,04	6,5 cm

CAMPANILLA DE BARRA

acero inoxidable, ABS

BEST SELLER



Réf.			
N8040	8,5	7	0,11

EL CORTADOR «LUTIL»

Se destaca por su diseño trabajado y estilo retro. Hecho en pequeñas series, es una obra de arte única, grabada con su número de edición de la mano del creador y completamente ensamblada a mano. Certificado de autenticidad, mango ergonómico, perilla de bloqueo de la hoja, tres almohadillas antideslizantes, bolsillo para salchicha de lino.

Cuchilla extraíble masiva

Cuerpo de aluminio fundido pintado, hoja de acero inoxidable afilable



Réf.				
TAS	25	9,5	8,5	1,2

RACK DE COPAS

5 hileras. Cerca de 20 copas. Doble fijación: a la pared y/o bajo repisa.

4 tornillos y tacos

Acero cromado

BEST SELLER



LOUIS TELLIER

Réf.				
NC018D	45	32	6	1,7

CAFETERA DE BUFFET

Termostato de seguridad con reajuste automático. Bloqueo de la tapadera. Escala graduada de nivel de llenado. 2 resistencias separadas (calienta + mantiene la temperatura)

Doble pared y asas aislantes. Función de conservación de la temperatura.

Tazas : N5308 = 50 / N5312 = 75 / N5316 = 100. Volumen nominal : N5308 = 6.3L / N5312 = 9.6L / N5316 = 13.2L.

Grifo antigoteo. Filtro permanente de acero inoxidable para molienda estándar. Sistema de bloqueo de la tapa.

Acero inoxidable cepillado

N5308 : 14 cl/min - N5312 : 24 cl/min - N5316 : 24 cl/min

50 Hz - 950 W - 230 V



LT
LOUIS TELLIER

Réf.	Ø	I	Peso	Volumen
N5308	22	42	3	6,3 L
N5312	27	43	3,82	10 L
N5316	27	51	4,35	13,2 L

CALENTADOR DE AGUA Y GRIFO

Con grifo para poder servir. Temperatura ajustable.

Max. 20 L - Min. 5 L

Grifo de seguridad

Acero inoxidable

100°C : 40 min / 10L o 1 h / 20L.
70°C : 25 min / 10L o 37 min / 20L.
50°C : 13 min / 10L o 30 min / 20L.

2100 W - 230 V

+30°C à +100°C



Réf.	Ø	I	Peso	Volumen
N8091	37	46	5,7	

CHOCOLATERA

Depósito extraíble para refrigeración y lavado. Grifo totalmente desmontable para limpieza con vapor. Termostato regulable.

Producción : 30 min. Calentamiento : 15 min.

5 L

Grifería y depósito antigoteo.

ABS, Tritan

50 Hz - 1100 W - 230 V

+30°C à +90°C



Réf.	Ø	I	Peso
N4905	48,5	52	6

JARRAS ISOTÉRMICAS DE SERVICIO TORNILLO

Capa de inox. de doble pared con vacío. Irrompible. Asa aislante. Bebidas calientes : 6h : >70°C (T°ambiente 20°C). Bebidas frías : 12h : <15°C (T°ambiente 35°C).

Acero inoxidable, ABS



LT
LOUIS TELLIER

Réf.	Ø	I	Peso	Volumen
N5069	13	22	0,6	1 L

TAPÓN ENROSCABLE

Ergonómico. Estanco.

ABS



LT
LOUIS TELLIER

Réf.	Ø	I	Peso	Código
N5069-B	10	8	4,5	0,02

JARRAS ISOTÉRMICAS DE SERVICIO GATILLO

Capa de inox. de doble pared con vacío. Irrompible. Asa aislante. Bebidas calientes : 6h : >70°C (T°ambiente 20°C). Bebidas frías : 12h : <15°C (T°ambiente 35°C).

Acero inoxidable, ABS

BEST
SELLER



LT
LOUIS TELLIER

Réf.	Ø	I	Peso	Volumen
N5070	14	19	0,75	1,2 L
N5071	14	22	0,9	1,5 L
N5072	14	26	2,6	2 L

TAPÓN CON GATILLO

Certificado NF. Servicio fácil. Estanto.

ABS

LOUIS TELLIER

Réf.	↔	↗	⌋	📦	🔍
N5072-B	10	9	4,5	0,06	N5070 / N5071 / N5072

JARRA ISOTÉRMICA BLANCA

Doble pared con vacío. Exterior de ABS. Interior de PP. Irrompible. Aspecto de porcelana. Ideal para hostelería, hospitales, instituciones residenciales para personas mayores dependientes...

Tapa sellada con gatillo de servicio

ABS, polipropileno

LOUIS TELLIER

Réf.	↔	↗	⌋	📦	🔍
N5076	18	9	20	0,5	0,6 L
N5077	22	13,5	25	0,8	1,2 L

JARRA ISOTÉRMICA NEGRA

Doble pared con vacío. Exterior de ABS. Interior de PP. Irrompible. Aspecto de porcelana. Ideal para hostelería, hospitales, instituciones residenciales para personas mayores dependientes...

Tapa sellada con gatillo de servicio

ABS, polipropileno

LOUIS TELLIER

Réf.	↔	↗	⌋	📦	🔍
N5078	17,5	12	21	0,5	0,6 L

JARRAS ISOTÉRMICAS CON DOSIFICADOR

Capa de inox. de doble pared con vacío. Jarra con bomba. Servicio fácil mediante presión. Irrompible. Bebidas calientes : 6h : >70°C (T°ambiente 20°C). Bebidas frías : 12h : <15°C (T°ambiente 35°C).

Asa de transporte

Acero inoxidable, ABS

LOUIS TELLIER

Réf.	↔	↗	⌋	📦	🔍
N5084	21,5	15	32	1,3	1,9 L
N5085	21	14,5	36	1,5	2,5 L
N5088	18	24	33	2	3 L
N5089	26	17	38,5	2,2	4 L

JARRA ISOTÉRMICA TRENZADA



Tapa **giratoria**
de apertura con el pulgar
para servir

Aislamiento de
**espuma de
poliuretano**

Incluye **tres clips** de
plástico **con código de
color** para reducir la
confusión entre las bebidas

Revestimiento de policarbonato
resistente a los golpes

Aislamiento con triple pared para mantener las bebidas a la temperatura ideal.
Excelente durabilidad y gran resistencia a los golpes, desconchaduras y grietas.
2 capacidades: 1,2 l o 0,9 l.
2 colores: blanco o negro.



SALA Y BUFFET

ACCESORIOS DE MESA	139
ACCESORIOS PARA EL BUFFET	141
ACCESORIOS DE SERVICIO	143
ACCESORIOS PARA PEDIDOS	144

MOLINILLO PARA PIMIENTA

PERFEX

PERFEX[®]



¡El no va más de los hermosos objetos vintage made in France !

Apreciados por los coleccionistas, presentes en las principales mesas extranjeras desde hace siete década y regalados de generación en generación en las grandes familias americanas e inglesas, los molinillos Perfex, fabricados en Francia, están disponibles en el mercado francés.

Los molinillos Perfex, fabricados en series limitadas en Francia desde 1946 en un taller de mecánica de alta precisión, son joyas de técnica.

De aluminio moldeado robusto, dotado de un mecanismo de acero especial, tallado y tratado que garantiza una trituración óptima, este molino con diseño «industrial» y embalaje «vintage» es intemporal. Atención : no se aceptan devoluciones ni cambios.

MOLINILLO DE SAL

Con solamente la presión del pulgar! En la cocina o en la mesa. Vendido vacío.

Acero inoxidable



Réf.			
N4150	2,7	13,5	0,18

MOLINILLO DE PIMENTA

Con solamente la presión del pulgar! En la cocina o en la mesa. Vendido vacío.

Acero inoxidable



Réf.			
N4151	2,7	2,5	0,18

MOLINILLO PARA PIMIENTA PERFEX® - 40G

Boca de llenado patentada. Posibilidad de regular el grosor del molinillo.

40 g

Acero de carbono, cuerpo de aluminio fundido



PERFEX

Réf.			
N4153	7	66	11
			0,3

MOLINILLO PARA PIMIENTA PERFEX® - 110G

Boca de llenado patentada. Posibilidad de regular el grosor del molinillo.

110 g

Acero de carbono, cuerpo de aluminio fundido



PERFEX

Réf.			
N4154	9	9	19
			0,84

MOLINILLO PARA SAL PERFEX®

Boca de llenado patentada. Posibilidad de regular el grosor del molinillo.

40 g

Acero inoxidable, cuerpo de aluminio fundido



PERFEX

Réf.			
N4155	7	5,8	11,1
			0,3

HUEVERA ESPIRAL

Acero cromado



Réf.			
NC036	4,5	6	0,05

SOPORTE PARA BANDEJA DE MARISCOS

Ø arriba : 19 cm.

 BEST
SELLER

LOUIS TELLIER

Réf.	Ø	H	Peso	Material
NC020	20	19,5	0,26	Inox.
NC020-C	20	19,5	0,27	Acero cromado

SOPORTE DE MESA PARA CUBO CHAMPÁN

Alambre de 8 mm: mayor resistencia. Se fija al borde de la mesa.

Cubo no incluido

Acero cromado

LOUIS TELLIER

Réf.	Ø	H	Peso
NC024	49	21	17,5

SERVILLETERO RECTANGULAR

Acero inoxidable

NEW

LOUIS TELLIER

Réf.	L	W	H	Peso
LT20P004	13	8,5	3	0,1

CESTA DE PAN / FRUTA 24 CM

Acero inoxidable

LOUIS TELLIER

Réf.	Ø	H	Peso
LT20P003	24	8	0,21

CESTA DE PAN / FRUTA 20 CM

Acero inoxidable

LOUIS TELLIER

Réf.	Ø	H	Peso
LT20P002	20	8	0,18

CESTA PARA CITRICOS

Acero inoxidable

BEST SELLER



Réf.			
N4110	23	25	0,66

PORTA-TOSTADAS

Para 6 rebanadas. Intervalo entre cada arco : 20 mm.

Acero cromado

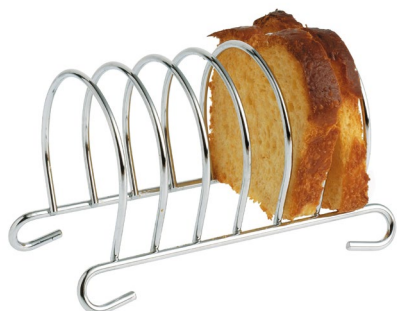

Réf.				
NC061	15	8	9	0,14

CALIENTAPLATOS «TRAPECIO»

Alambre Ø5mm.

2 velas candelita

Acero cromado

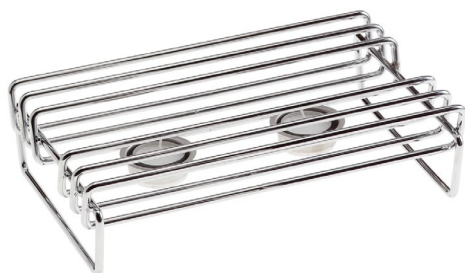

LOUIS TELLIER

Réf.				
NC3016050	30	19	8	0,92

CESTA SNACKING

Ideal para autoservicio: bocadillos, latas, ensaladas y platos en recipientes.

Meseta

Bandeja de PP, cesta cromado



Réf.				
NC7020160	30	24	12,5	0,6

CALIENTAPLATOS CON VELA

Entregado con velas que no desprenden humo.

Cubo en acero bruñado

Alambre de acero cromado



LOUIS TELLIER

Réf.					
803CHP1	20	19,5	6,5	0,47	1 vela
803CHP2	34	20	6,5	0,7	2 velas
803CHP3	47	20	6,5	0,98	3 velas

DISPENSADORES DE SALSAS PARA ESPECIALISTAS EN RESTAURACIÓN COLECTIVA

Porción de salsa 40 ml (ajustable). Bombas dispensadoras de salsas diseñadas para un uso intensivo, adaptado a los especialistas en restauración colectiva y comida rápida. Mecanismo de palanca totalmente de inox.

Cierre de tapa por resortes

Tubo, bomba y tanque de acero inoxidable



LOUIS TELLIER

Réf.			
NDS500	18	42	5L

PINZA PARA ENSALADA

Acero inoxidable

LOUIS TELLIER

Réf.				
N3066	24	9	4,5	0,12

PINZA MULTIUSO

Ideal para buffets, catering de empresa, etc. Calidad superior.

Acero inoxidable

LOUIS TELLIER

Réf.					
N3067	24	3,5	4	0,1	24 cm
N3068	30	4	3,5	0,15	30 cm
N3069	40	4	4	0,2	40 cm
N3072	23	4	3	0,05	23 cm
N3073	30	3,8	3	0,07	30 cm
N3074	40	3,5	3	0,09	40 cm

PINZA DE INOX. Y PVC

Acero inoxidable y PVC

LOUIS TELLIER

Réf.				
LT2117	24	10	4	0,136
LT2118	30	14,5	4	0,178
LT2119	40	5	4	0,198

PINZA DE INOX.

Acero inoxidable

LOUIS TELLIER

Réf.				
LT2127	18	6,5	3	0,047
LT2128	24	7,2	3,5	0,089
LT2129	30	11,5	4	0,098
LT2130	40	13,5	3,5	0,147

RECOGEMIGAS

Modelo de bolsillo. Mango estilo nudo de olmo.

Gancho para bolígrafo

Acero inoxidable y plástico



LOUIS TELLIER

Réf.					
RAM	14	3	1	0,04	Blistar

BANDEJA DE ADICIÓN REDONDA

Acero inoxidable



LOUIS TELLIER

Réf.			
LT19P002	14	1,5	0,06

BANDEJA RECTANGULAR ADICIONAL

Acero inoxidable



LOUIS TELLIER

Réf.				
LT19P001	17	11,5	1	0,1

PINZA PORTA FICHAS CON BOLITAS

Para mantener una buena comunicación entre el comedor y la cocina.

Tornillos y tacos

Acero inoxidable y cuentas de cristal

BEST SELLER



LOUIS TELLIER

Ref.					
N8028	25	7,5	2	0,27	25 cm
N8029	50	7,5	2	0,42	50 cm

PINZA PORTA FICHAS CON MUELLES

8 resortes. Para ordenar perfectamente las comandas.

Tornillos y tacos

Acero inoxidable

BEST SELLER



LOUIS TELLIER

Ref.					
N8030	64	10	2	0,8	8 muelles
N8031	100	10	1,5	1	13 muelles

TACO DE NOTAS

Fijación mural.

Portalápices y rollo de papel, 2 tornillos y tacos

Acero inoxidable



Ref.				
N8033	24	10	6,5	0,33

PORTAFICHAS DE 8 RESORTES

LT
LOUIS TELLIER
BIEN NE REMPLACE LE PATI-MAN

**BEST
SELLER**

Imprescindible
en todas las cocinas

8 resortes



Incluye
tornillos y clavijas

Para **ordenar**
perfectamente las comandas

¡Un elemento imprescindible en todas las cocinas!

La forma del resorte está especialmente estudiada para colocar cualquier formato y calidad de ficha sin tener que tocarlo.

Fabricación de inox. para mantener una higiene óptima.

También disponible en 1 m con 13 resortes.



CONSERVACIÓN

ENVASADORA AL VACÍO	149
REGLAS Y DISPENSADORES	150
DESHIDRATADORES	151
CAJA DE ESPECIAS	153

DISPENSADOR PARA FILM TRANSPARENTE Y ALUMINIO



LOUIS TELLIER
BIEN NE REMPLACE LE FAIT MAINT



Film alimentario : la regla cortadora de film se desliza sobre el borde y hace un corte **neto** y **rápido**

Papel de aluminio : borde dentado **ultra resistente**

Muestras + tornillos y clavijas para **fijación mural**



Ventosas para la estabilidad en la encimera

Se adapta a **todos los anchos** de rodillos

Perforación para cadenas : evita la desaparición de los rodillos

Este producto permite el almacenamiento de los rodillos respetando las buenas reglas de higiene para proteger los alimentos.

ENVASADORA AL VACÍO SEMI-PROFESIONAL

Bomba de 2 pistones autolubrificante. Canal y depósito para líquidos: parada automática de la máquina para evitar dañar la bomba. Bloqueo automático durante la puesta al vacío. Parada automática a -0,5 bar. Tiempo de pausa entre 2 puestas al vacío: 20 s. Función selladora de bolsas. Banda térmica L. 30 cm. Para cocinar y conservar al vacío.

22,5 L /min

Boquilla de aspiración y adaptador para recipientes, tapas, jarra, tapón de la gama. Compartimento para rollos y cortador de bolsas. 2 rollos (1,5m x20cm + 1,5m x28cm) + 3 bolsas 28x36cm + 3 bolsas 20x28cm.

ABS

- 0,8 bar. 2900 tpm.

50 Hz - 240 W - 230 V



Ref.				
NV400	38	25	10	3,6

BOLSAS AL VACÍO GOFRADAS

Lote de 25 bolsas. Malla especialmente diseñada para evacuar mejor el aire durante la aspiración y para crear una junta estanca durante el sellado. Adaptadas para cocinar al vacío y conservar. Baño maría, microondas, frigorífico, congelador.

Película bicapa de PA/PE, PA 1 micra, PE 13 micras

-20°C à +100°C



Ref.				
NV010	36	28	0,56	Lote de 25 bolsas 36 x 28 cm
NV011	28	20	0,52	Lote de 40 bolsas 28 x 20 cm
NV012	55	13	0,51	Lote de 30 bolsas 55 x 13 cm

RODILLOS GOFRADOS PARA ENVASAR AL VACÍO

Para cortar y sellar según las medidas que precise. Malla especialmente diseñada para evacuar mejor el aire durante la aspiración y para crear una junta estanca durante el sellado. Adaptados para cocinar al vacío y conservar. Baño maría, microondas, frigorífico, congelador.

Película bicapa de PA/PE, parte lisa : espesor 130 micras, parte gofrada : espesor 13 micras

-20°C à +100°C



Ref.				
NV013	300	28	0,56	Lote de 3 rodillos
NV014	300	20,5	0,59	Lote de 4 rodillos
NV015	13	13	0,46	Lote de 5 rodillos

CAJA DISTRIBUIDORA PARA BOLSAS DE PLASTICO

Fijación mural o sobre mesa.

Acero inoxidable

LOUIS TELLIER

Réf.				
B1095	14,5	9,5	31,5	1,1

DISPENSADOR PARA FILM TRANSPARENTE Y ALUMINIO

Vástago portarrollos fino: se adapta a todos los diámetros de tubos. Dimensiones internas > desde 10 cm hasta la anchura del film para adaptarse a rollos de cualquier anchura. NF Higiene alimentaria: almacenamiento de los rollos respetando las reglas de higiene para proteger los alimentos. Borde dentado para papel de aluminio, regleta corta-film para film alimentario. Para colocar sobre una superficie o fijar a la pared.

Regla cortadora de film, 4 ventosas, 2 tornillos + tacos

Acero inoxidable

LOUIS TELLIER

Réf.						
DFV300	40	14	16	2	30cm	
DFV450		56	14	16	2,8	45 cm

DISPENSADOR DE PAPEL

Anchura rodillo: 35 cm Ø 20,5 cm. Modelo de mostrador.

Acero inoxidable

LOUIS TELLIER

Réf.				
DP000	45	29	33	0,9

REGLETA CORTA-FILM

Para introducir en el borde de los desenrolladores de acero inoxidable o las cajas cartón. Deslizar el cursor: el film se corta limpiamente.

PP



Réf.						
DF030		40	4,5	1,5	0,06	30 cm
DF045		55	5	2	0,1	45 cm

DESHIDRATADOR DE FRUTAS Y VERDURAS

No programable. Para conservar, decorar y innovar: chips ligeros de verduras secadas y concentradas de azúcar...

5 bandejas apilables

ABS, Tritan

50 Hz - 250 W - 220/240 V

Max. 80°C



Réf.			
N3040	33	20	3,2

DESHIDRATADOR DE FRUTAS Y VERDURAS PROGRAMABLE

Hasta 20 bandejas. Timer y control de temperatura. Para conservar, decorar y innovar: chips ligeras de verduras secadas concentradas de azúcar...

6 bandejas apilables

ABS

50 Hz - 530 W - 220/240 V

30°C - 80°C (86-248°F)



Réf.				
N3042	43,5	29	21	3,6

ACCESORIOS PARA DESHIDRATADOR NO PROGRAMABLE

PP, Tritan



Réf.							
N3040-F	29,5	29,5	0,1		0,04	Hoja plastificada	
N3040-P				33	3	0,1	Bandeja

ACCESORIOS PARA DESHIDRATADOR PROGRAMABLE

PP, ABS



Réf.					
N3042-F	44	29	0,1	0,06	Lote de 2 hojas plastificadas
N3042-P	43	29	3	0,26	Bandeja

CAJAS JAPONESAS DE INOX



Duradera,
sin degradación del material

Acero inoxidable **18/8**



Higiénica :
se lava **fácilmente**

Proteccion
contra la luz

Frescor larga duración gracias a la
conductividad del acero inoxidable

Perfecta para preservar sus presentaciones de la mañana : limpieza y frescura conservadas desde por la mañana en el frigorífico, hasta el servicio en la encimera.

CAJA DE ESPECIAS INOX. - 4 CUBETAS PEQUEÑAS DE PP

Recipientes amovibles: 14 x 7,7 x 7 cm. Sus ingredientes, aderezos y especias al alcance de la mano. Para bocadillos, pizzas, sushis, makis, emplatados, cócteles...

1 recipiente = 47 cl / 500 g.

Acero inoxidable



Ref.						
N4401	30	14,5	10	0,24		4 compartimientos

CUBETA PEQUEÑA DE PP PARA N4401/N4402/N4403

Recipientes amovibles: 14 x 7,7 x 7 cm. Sus ingredientes, aderezos y especias al alcance de la mano. Para bocadillos, pizzas, sushis, makis, emplatados, cócteles...

1 recipiente = 47 cl / 500 g

PP



Ref.						
N4404	14	7,7	7	0,04		Compartimiento N4401 / N4402 / N4403

CUBETA PEQUEÑA DE PP PARA N4408

Recipientes amovibles 14 x 11 x 7 cm. Sus ingredientes, aderezos y especias al alcance de la mano. Para emplatados, pizzas, sushis, makis, cócteles...

1 recipiente = 78 cl / 850 g.

ABS, PP



Ref.					
N4409	14	11	7		Compartimiento N4408

CAJA DE ESPECIAS INOX. - 6 CUBETAS PEQUEÑAS DE PP

Recipientes amovibles: 14 x 7,7 x 7 cm. Sus ingredientes, aderezos y especias al alcance de la mano. Para bocadillos, pizzas, sushis, makis, emplatados, cócteles...

1 recipiente = 47 cl / 500 g.

Acero inoxidable



Ref.						
N4403	45	14,5	9,5	1,15		6 compartimientos

CAJA DE ESPECIAS DE ABS - 4 COMPARTIMENTOS DE PP

Recipientes amovibles 14 x 11 x 7 cm. Sus ingredientes, aderezos y especias al alcance de la mano. Para emplatados, pizzas, sushis, makis, cócteles...

1 recipiente = 78 cl / 850 g.

ABS, PP



Ref.						
N4408	49	15	9,5	1,2		4 compartimientos

PEQUEÑAS CAJAS JAPONESAS EN CONTENEDOR

Acero inoxidable 18.8



LOUIS TELLIER

Ref.						
N4410	28	11,5	6			4 x cajas N4390T
N4411	22,4	14,9	6,3	1,64		5 x cajas N4391T
N4412	32,8	14,8	6,3			6 x cajas N4390T
N4413	43,2	14,8	6,3			8 x cajas N4390T

CAJA JAPONESA

Acero inoxidable 18.8

LOUIS TELLIER

Ref.					
N4390C	11,6	7,7	0,8	Tapa	N4390T
N4390T	10,5	6,8	5,8	Recipiente	N4390C
N4391C	14,7	11,6	1	Tapa	N4391T
N4391G	11,6	8,4	1,1	Rejilla	N4391T
N4391T	13,7	10,6	6	Recipiente	
N4392C	17,4	12,3	1	Tapa	N4392T
N4392G	14,3	9,2	1,1	Rejilla	N4392T
N4392T	16,2	11,1	6,7	Recipiente	





HIGIENE

DISPENSADORES

159

DISPENSADOR HIGIENIZANTE INOX



HIGIENE

Capot superior.
Se abre para cambiar la botella y regular la altura.

Apto para todas las botellas :
Dosificadoras con diámetro máximo de **11 cm** y altura de **7 a 30 cm**

Se acciona
con el pedal

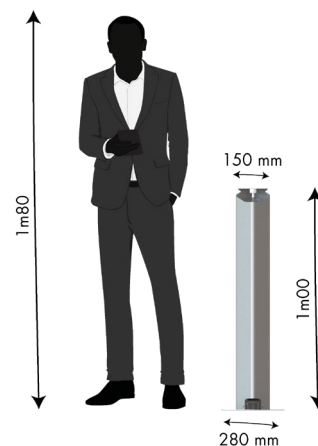

Antirrobo :
- Apertura estrecha (6 cm)
- Atornillada (Llave allen incluida)

Indicador
del nivel de la botella dosificadora

Acero inoxidable
100%

- Base pesada muy **estable**
(ancho 280 mm)
- Posible **fijación al suelo**
si deseado (2 agujeros diam. 11 mm)

Dispensador Universal de gel hidroalcohólico con pedal. Sin pedal para la mayor higiene.

- Acero inox plegado 2D
- Acabado en mate (se entrega con film protector de PVC)
- Se entrega sin botella dosificadora de gel hidroalcohólico

2 años de garantía

DISPENSADOR HIGIENIZANTE UNIVERSAL CON PEDAL - TODO INOX

Dispensador Universal de gel hidroalcohólico con pedal, ¡Sin contacto para la mayor higiene! Todo acero inoxidable, sólido y duradero. 100% mecánica, accionada por pedal. Apto para todas las botellas: Dosificadoras con diámetro máximo de 11 cm y altura de 7 a 30 cm

Campana para atornillar - llave allen incluida

Acero inoxidable



LOUIS TELLIER



Réf.				
SHPX	26	29	100	5,2

DISPENSADOR HIGIENIZANTE DE PARED - TODO INOX

Para una higiene óptima.

Acero inoxidable



LOUIS TELLIER



Réf.				
SHMX	11,5	13	32,5	1,8

CAJAS DISPENSADORAS PARA CHARLOTES DESECHABLES - NF

Tornillos y tacos

Acero inoxidable



LOUIS TELLIER



Réf.					
B1000.	26	10,5	28	3	Para cajas de gorros redondos

CAJA DISPENSADORA PARA MASCARAS DESECHABLES - NF

Tornillos y tacos

Acero inoxidable



LOUIS TELLIER



Réf.				
B1010.	8,7	4,7	26	0,52

CAJAS DISPENSADORAS PARA GORRAS DE PAPEL DESECHABLES - NF

Tornillos y tacos

Acero inoxidable



LOUIS TELLIER



Réf.					
B1020.	29,5	10,5	14,5	1,8	Para cajas

CAJAS DISPENSADORAS PARA GUANTES DESECHABLES - NF

Tornillos y tacos

Acero inoxidable



LOUIS TELLIER



Réf.					
B1030.	25	14	9	1,5	Distribución de bajo
B1035.	25	13,5	8	1	Distribución de frente

CAJAS DISPENSADORAS PARA CHARLOTTES DESECHABLES - NF

- Tornillos y tacos
- Acero inoxidable



Réf.					
B1050.	31	27,7	19,5	6	Para cajas de gorros clip no tejidos

CAJAS DISPENSADORAS PARA KIT VISITANTES - NF

Para atornillar directamente a la pared.

- Tornillos y tacos
- Acero inoxidable



Réf.					
B1060.	12,3	10,4	43,5	2	

SOPORTE DE PARED PARA CAJA PARA GORROS REDONDOS

Para una higiene óptima.

- Acero inoxidable



Réf.					
B1000E	25,3	10,2	27,3	0,92	

SOPORTE DE PARED PARA CAJA PARA MASCARAS

Para una higiene óptima.

- Acero inoxidable



Réf.					
B1010E	8,7	4,7	25,8	0,33	

SOPORTE DE PARED PARA CAJA PARA GORRAS DE PAPEL

Para una higiene óptima.

- Acero inoxidable



Réf.					
B1020E	29,7	9,6	13	0,55	

SOPORTE DE PARED PARA CAJA PARA GANTES

Para una higiene óptima. Salida delantera.

- Acero inoxidable

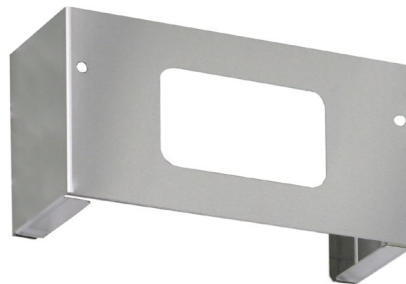







Réf.					
B1035E	23	8	13	0,4	

CEPILLO DE HORNO

 Cepillo de acero inoxidable, mango de madera

BEST SELLER



Réf.					
NBR01	 28	3,5	5,5	0,12	Con mango
NBR02	17	6,5	8	0,3	Con mango corto



AMISTOSO



MÁQUINAS DE RACLETTE Y FONDUES 165

BRASEROS Y PLANCHETTAS 171

BROCHETAS 174

AHUMADERO 176

MÁQUINAS DE RACLETTE BRÉZIÈRE® LA GAMA SIGNATURE



LOUIS TELLIER

BÊCHÉ NE REMPLACE LE FAIT MAÏN



Modelo **plegable** con gancho de transporte : dimensiones exteriores reducidas, fácil de guardar y de utilizar



Se adapta al número de comensales (de 1 a 4 personas)

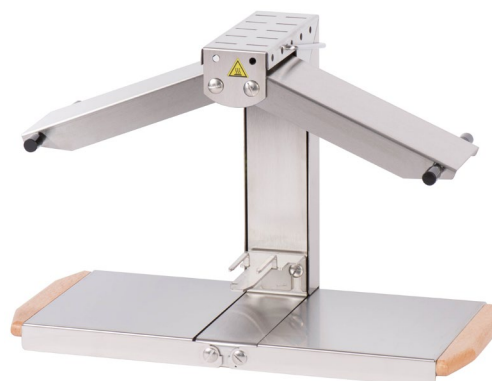

Porta queso de acero inoxidable desmontable : lavable en lavavajillas

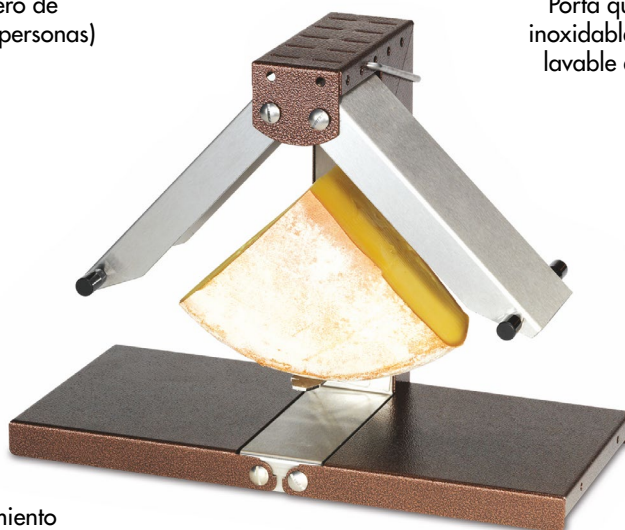

Rampas de calentamiento **ajustables** en altura según la porción de queso : de 1/6 a 1/3 del molde como máximo

Acero inoxidable y acero pintado epoxídico

Cable de **2,20 m**

Accesorios disponibles para hacer la Reblochonade entera REB02 y mitad REB03. El cuchillo especial raclette CAR01 se vende por separado.

MÁQUINA DE RACLETTE BRÉZIÈRE® - SIGNATURES - ORIGINAL

El original en su color bronce texturizado, se adapta al número de invitados (de 1 a 4 personas). Rampas de calentamiento ajustables en altura de acuerdo con la porción de queso: de 1/6 a un máximo de 1/3 muela abrasiva. Dispositivo plegable: tamaño reducido. Porta-queso amovible.

Switch de ignición. Asa de transporte. Quesero extraíble apto para lavavajillas. Cable : 2,20 m.

Acero inoxidable, acero pintado con epoxi

850 W - CE - 230 V



LOUIS TELLIER



Réf.					
BREZ01	44,5	21,5	30	3,46	Brézière® 230V
BREZ01C	44,5	21,5	30	3,55	BREZ01 230V + CAR01
BREZ02	44,5	21,5	30	3,46	Brézière® 110V
BREZ02C	44,5	21,5	30	3,55	BREZ02 + CAR01
BREZ03	44,5	21,5	30	3,46	BREZ01 + UK echufe
BREZ04	44,5	21,5	30	3,46	BREZ01 + echufe suízo

MÁQUINAS DE RACLETTE BRÉZIÈRE® - SIGNATURES - BASALTE

Basalte, color negro, para un estilo moderno. Hasta 6-8 personas. Caja de calentamiento horizontal ajustable en altura por cremallera. Porta quesos inclinable y extraíble fácilmente. interruptor de encendido.

Switch de ignición. Asa de transporte. Quesero extraíble apto para lavavajillas. Cable : 2,20 m.

Acero inoxidable, acero pintado con epoxi

850 W - CE - 230 V



LOUIS TELLIER



Réf.					
BREZ01BA	44,5	21,5	30	3,46	Brézière® 230V

MÁQUINAS DE RACLETTE BRÉZIÈRE® - SIGNATURES - INOX.

L'Inox, todo material y color de inox con mango de haya maciza, para un estilo chic clásico. Hasta 6-8 personas. Caja de calentamiento horizontal ajustable en altura por cremallera. Porta quesos inclinable y extraíble fácilmente. interruptor de encendido.

Switch de ignición. Asa de transporte. Quesero extraíble apto para lavavajillas. Cuerda: 2,20 m.

Acero inoxidable

850 W - CE - 230 V



LOUIS TELLIER



Réf.					
BREZ01NX	44,5	21,5	30	3,46	Brézière® 230V

MÁQUINA DE RACLETTE ALPAGE® - SIGNATURES - ORIGINAL

El Original color bronce texturizado, para un estilo tradicional. Hasta 6-8 personas. Caja de calentamiento horizontal ajustable en altura por cremallera. Porta quesos inclinable y extraíble fácilmente. interruptor de encendido.

Cable : 2,20 m

Acero inoxidable, acero pintado con epoxi

850 W - 230 V



LOUIS TELLIER



Réf.					
RACLO1	46	26,5	40	3,76	230 V - 850 W
RACLO2	46	26,5	40	3,76	110 V - 900 W
RACLO2C	46	26,5	40	3,84	RACLO2 + CAR01
RACLO3	46	26,5	40	3,76	RACLO1 + UK echufe

MÁQUINA DE RACLETTE ALPAGE® - SIGNATURES - BASALTE

Basalte, color negro, para un estilo moderno. Hasta 6-8 personas. Caja de calentamiento horizontal ajustable en altura por cremallera. Porta quesos inclinable y extraíble fácilmente. interruptor de encendido.

Acero inoxidable, acero pintado con epoxi

850 W - 230 V



LOUIS TELLIER



Réf.					
RACL01BA	44,5	21,5	30	3,55	230 V - 850 W

MÁQUINA DE RACLETTE ALPAGE® - SIGNATURES - INOX.

L'Inox, todo material y color de inox con mango de haya maciza, para un estilo chic clásico. Hasta 6-8 personas. Caja de calentamiento horizontal ajustable en altura por cremallera. Porta quesos inclinable y extraíble fácilmente. interruptor de encendido.

Acero inoxidable

850 W - 230 V



LOUIS TELLIER



Réf.					
RACL01NX	46	26,5	40	3,55	230 V - 850 W

ACCESORIO «REBLOCHONNADE» PARA MÁQUINA ALPAGE®

Para cocinar 2 reblochons. Accesorios diseñados para máquinas ALPAGE® para variar recetas.

2 sartenes + 2 espátulas + 1 bandeja

Bandeja de acero inoxidable



LOUIS TELLIER

Réf.					
REB01	53	26,5	40	1,88	RACL01 / RACL02 / RACL02C / RACL03

ACCESORIO «REBLOCHONNADE» PARA RACLETTE BRÉZIÈRE®

Para cocinar 2 reblochons. Accesorios diseñados para máquinas Brézière® para variar recetas.

2 sartenes + 2 espátulas + 1 bandeja.

Bandeja de acero inoxidable



LOUIS TELLIER

Réf.					
REB02	32	14	11	1,9	BREZ01 / BREZ02 / BREZ03

ACCESORIO «REBLOCHONNADE» + RACLETTE PARA BRÉZIÈRE®

Para cocinar un trozo de queso Raclette por un lado y un Reblochon por el otro. Accesorios diseñados para máquinas Brézière® para variar recetas.

1 sartén + 1 espátula + 1 bandeja

Bandeja de acero inoxidable



LOUIS TELLIER

Réf.		
REB03	0,76	BREZ01 / BREZ02 / BREZ03

BROCHETAS PARA MÁQUINA DE RACLETTE ALPAGE®

Para cocinar 2 pinchos a la vez y hacer tostadas calientes con queso derretido. Accesorios diseñados para máquinas ALPAGE® para variar recetas.

1 bandeja + 4 brochetas de 40 cm.

Bandeja y brochetas de acero inoxidable

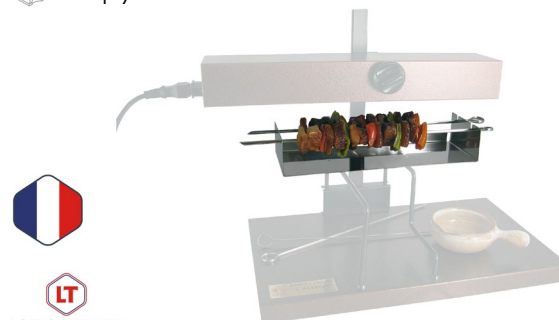

LOUIS TELLIER

Réf.					
BROCH01	40	12	6	0,52	RACL01 / RACL02 / RACL02C / RACL03

CUCHILLO ESPECIAL RACLETTE

1 lado liso para raspar y 1 lado microdentado para hacer «religieuses».

Hoja de acero templado, mango de madera vernizado, remaches de latón



LOUIS TELLIER

Réf.				
CAR01	24	4,5	1,5	0,08



PINCHO PARA PATATA

Para sujetar la patata sin quemarse mientras se pela.

Pico de acero inoxidable, mango de madera

Réf.				
N4504	12,5	2	2	0,02



PATATERA DE MADERA

Para mantener las papas calientes para sus raclettes, fondues, etc.

Madera natural blanco



LOUIS TELLIER

Réf.							
SEP-OC	30	20	14,5		0,92	Ovalado con tapa	
SEP-RC				21,5	20	0,68	Redondo con tapa
SEP-R				20	18	0,53	Redondo sin tapa



FUNDIDOR DE QUESO

With quemador. Bandeja reclinable.

1 quemador
 Antiadherente bicapa, acero inoxidable

TTM

Réf.				
TTM03	15/21	30	15	1,75



RACLETTE TRADICIONAL «PARTY»

Para 1/4 de queso. Hasta 4 personas. Longitud del cable: 1.10 m.

Bandeja y brazo giratorio de acero recubierto de polvo, soporte de acero cromado, cuerpo con recubrimiento de alta temperatura

600 W

TTM

Réf.					
TTM05	28	24	34	2,7	230V
TTM05C-110	29	24	32	2,8	110V



RACLETTE TRADICIONAL «AMBIANCE»

Para 1/2 rueda de queso. Hasta 6-8 personas

Bandeja y brazo giratorio de acero recubierto de polvo, soporte de acero cromado, cuerpo con recubrimiento de alta temperatura

1000 W

TTM

Réf.					
TTM10	48,5	28	32	5,7	230V
TTM10C-110	48,5	28	32	5,61	110V



RACLETTE TRADICIONAL 2 X 1/2 QUESO

Servicio continuo de raclette.

Bandeja y brazo giratorio de acero recubierto de polvo, soporte de acero cromado, cuerpo con recubrimiento de alta temperatura

1000 W

TTM

Ref.					
TTM20	54	29	33	7,4	230V

RACLETTE TRADICIONAL 3 X 1/2 QUESO

Servicio continuo de raclette.

Bandeja de acero pintado con epoxi, soporte de acero niquelado, cuerpo de acero ennegrecido (fosfatación)

2000 W - 230 V

TTM

Ref.				
TTM30	54	47	34	10,4

RACLETTE HORNO + GRILL 6 PERSONAS

Entregado sin espátula raclette. Para 6 personas.

6 sartenes

Bandeja antiadherente, sartén con mango de madera

900 W - 230 V

TTM

Ref.			
TTM40CE	28	13	1,94

SARTÉN RECTANGULAR - MANGO DE MADERA

Vendido individualmente.

Antiadherente, mango de madera

TTM

Ref.				
TTM02-PB	19	8,5	1,5	0,08

APARETOS DE RACLETTE PROFESIONAL

Todo inox para calidad profesional, robusto y duradero en el tiempo. Ultra bandeja para hornear antiadherente, tecnología «Obsidian» para verduras, carnes, etc. Enchufe para conectar varios electrodomésticos (se recomienda un máx. de 3). interruptor de encendido. Práctico y fácil de usar con sus 4 sartenes y su forma rectangular.

4 sartenes antiadherentes, mango de plástico + 4 espátulas de madera certificadas PEFC incluidas.

Acero inoxidable, bandeja antiadherente

600 W - 230 V

LOUIS TELLIER

Ref.					
RACP01NX	51	10	12	2,9	230V - 600W

CABLE DE CONEXIÓN «LE CONVIVAL»

Cable de conexión entre «Raclette profesional»

Elastomero y PVC

LOUIS TELLIER

Ref.				
5013	4	0,11	40 cm	RACP01NX
5029	4	0,12	70 cm	RACP01NX

ESTUFA DE LEÑA PARA FONDUE - DECORACIÓN «ABETO»

Kit fondue hasta 6 personas, el caldero de hierro fundido es adecuado para todo tipo de fondues.

2,5 L

1 quemador, 1 placa calentadora decorativa RECH-PS, un caldero CHAUDO1, 6 tenedores de fondue «arriba» FF06.

Acero pintado con epoxi, placa de acero inoxidable, fundicion



Réf.				
RECH02-KIT	28	21	25	5,23

HORNILLO PARA FONDUE - DECORACIÓN «ABETO»

Placa superior bloqueable.

Acero pintado con epoxi, placa de acero inoxidable



Réf.				
RECH02	22	12	1,43	CHAUDO1 / RECH02-KIT

ESPUMADERAS CHINAS EN FORMA DE CUCHARÓN

Lote de 4.

Clips de colores de identificación

Acero inoxidable



Réf.			
NC8090660	6	3,5	0,18

SOMBRERO TÁRTARO - MODELO CON QUEMADOR

Para cocinar rebanadas finas de carne, pescado, verduras o frutas en la tapa cónica con espadas. Sin humo, limpio y sin jugos quemados, los jugos se colectan en el borde del sombrero en el que se coloca un caldo sin grasa con verduras. Resistente a los choques térmicos.

3 quemadores

Chapa esmaltada al horno



Réf.			
TTM80AL	30	34	2,1

OLLA ELÉCTRICA DE FONDUE CHINA

Marmita para la fondue china: el caldo caliente permite cocinar verduras, fideos y finas lonchas de carne o pescado.

3,5 L

6 coladores TTMFC-P6 y 1 recetario

Cobre macizo martillado y estañado, mangos de madera

1200 W - 230 V



Réf.			
TTMFC01	30	32,5	3,77

SOMBRERO TÁRTARO - MODELO ELÉCTRICO

Para cocinar rebanadas finas de carne, pescado, verduras o frutas en la tapa cónica con espadas. Sin humo, limpio y sin jugos quemados, los jugos se colectan en el borde del sombrero en el que se coloca un caldo sin grasa con verduras. Resistente a los choques térmicos.

4 bandejas TTM80ECP.

Acero revestido antiadherente

1200 W - 230 V



Réf.			
TTM80E	30	30	2,5

BRASERO - BARBACOA DE MESA



Calidad profesional y robustez :

Materiales : Acero inoxidable = no se oxida / calidad 18/10
Parrilla gruesa de acero inoxidable pulido : es indeformable
 y reduce la adherencia de los alimentos

Totalmente desmontable :
 para un fácil mantenimiento



Estable para mayor seguridad gracias
 a su tabla de **haya maciza**

Inserción inferior
 para reservar o recalentar
 platos o sartenes

Funcional :

- **Rapidez de encendido** : listo para el empleo en 10 min, 20 min para las brasas
- **1 hogar móvil** para precalentar o reservar las brasas fuera de la mesa
- **1 recipiente** para gel de encendido para booster encendido

Esta barbacoa de exterior se coloca en el centro de una mesa para cocinar costillas de ternera, pescado, brochetas... en un césped, alrededor de la piscina, al pie de tus cañas de pescar... en todas partes según tus deseos, según tu imaginación !

Está equipado con un solo lado abierto para evitar la resistencia del viento para una seguridad óptima.

Es fácil de almacenar por su tamaño y su bloque cuadrado.

BRASERO SIN HORNO

Para cocinar rebanadas finas de carne en las brasas. Funciona con carbón de leña. Posible ignición en una estufa de gas (base del hogar perforado). Chimenea desmontable. Fabricado de acuerdo con los estándares de NF.

4 pies de goma

Acero pintado con epoxi, bandeja de madera de haya



LOUIS TELLIER

Réf.				
BRAS01	29	18	21,7	6,98

COMBINADOS BRASERO/RACLETTE DE REBLOCHON - «EDELWEISS»

Para cocinar rebanadas finas de carne en las brasas. Funciona con carbón de leña. Posible ignición en una estufa de gas (base del hogar perforado). Chimenea desmontable.

1 sartén de acero + 1 espátula compuesta (250°C)

Acero pintado con epoxi, bandeja de madera de haya



LOUIS TELLIER

Réf.				
BRAS-REB02	33	21,5	21,8	7,13

BRASERO - BBQ DE LA MESA

Ideal para asar al aire libre (costillas, pescado, etc.). Chimenea extraíble para encender el carbón y reservar las brasas. Totalmente extraíble para un fácil mantenimiento. calidad profesional

Acero inoxidable



LOUIS TELLIER

Réf.					
BRASI-F	32	22	21,5	7,3	Usó al aire libre : 1 lado abierto

BRASERO - REBLOCHONNADE

¡Perfecto para reblochade y asados a la parrilla en interiores! Fácil de usar con sus 2 lados abiertos para insertar la sartén. Chimenea extraíble para precalentar las brasas. Totalmente extraíble para un fácil mantenimiento. Calidad profesional

KIT Reblochonnade: 1 sartén de acero + espátula de composite

Acero inoxidable



LOUIS TELLIER

Réf.					
BRASI-O	32	22	21,5	7	Usó al aire libre : 2 lados abiertos

PLANCHETTA



LOUIS TELLIER

BIEN NE REMPLACE LE FAIT MAINT



Made in France

Para utilizar tanto en el **interior** como en el **exterior**

No se cae el zumo :
la placa esmaltada está ligeramente curvada en «punta de diamante»

Placa **irrompible** de acero esmaltado



Base de **madera**



Suministrado con **2 quemadores** pero emplazamientos previstos para **3**, para un calentamiento más potente

Calentamiento rápido por los quemadores : **10 minutos**

Esta planchetta le permitirá asar sus carnes directamente en la mesa. Accesorios paraviento de acero inoxidable (PLAN-PV) disponibles para utilizarla en el exterior.

MINI-PLANCHA DE MESA 4 PERS - BASE DE MADERA

La placa superior está perforada en el centro para permitir que las grasas fluyan en el contenedor provisto. Para 2 o 4 personas Placa de cerámica irrompible. Calentamiento rápido.

- 2 quemadores + un recipiente de acero inoxidable para recoger la grasa
- Placa de cerámica, base de madera, acero inoxidable



LOUIS TELLIER



Réf.				
PLAN01	33	22	14	4,4

MINI-PLANCHA DE MESA 4 PERS - BASE DE METAL

La placa superior está perforada en el centro para permitir que las grasas fluyan en el contenedor provisto. Para 2 o 4 personas Placa de cerámica irrompible. Calentamiento rápido.

- 2 quemadores + un recipiente de acero inoxidable para recoger la grasa
- Placa de cerámica, base de metal, acero inoxidable



LOUIS TELLIER



Réf.				
PLAN02	34,5	22	10	3,41

MINI-PLANCHA DE MESA 2 PERS

La placa (no perfora) es ligeramente convexa para evitar la caída de los jugos. Para 2 o 4 personas Placa de cerámica irrompible. Calentamiento rápido.

- 2 quemadores
- Placa de cerámica, base de madera, acero inoxidable



LOUIS TELLIER



Réf.				
PLAN05	37	17	14	3,72

PINZA PARA MINI-PLANCHA DE MESA

Soporte para agarrar la placa de cerámica caliente de las planchettas.

- Acero inoxidable



LOUIS TELLIER

Réf.					
PLAN-P	23	5	2	0,11	PLAN01 / PLAN02 / PLAN05

PROTECTOR DE VIENTO PARA MINI-PLANCHA DE MESAS - LOTE DE 2

Para optimizar el uso de las planchettas al aire libre: protege los quemadores del viento y garantiza un calentamiento continuo.

- Acero inoxidable



LOUIS TELLIER



Réf.				
PLAN-PV	10	9	0,32	PLAN01 / PLAN02 / PLAN05

PIEDRA DE PARRILLA CON SOPORTE

Para cocinar rebanadas finas de carne, pescado, verduras o frutas. La piedra se puede calentar en el horno (300°C max).

- 1 quemador
- Esteatita natural, base de alambre de acero cromado, mangos de madera



LOUIS TELLIER



Réf.					
PIER01	35,5	26,5	13,5	5,81	25 x 25 cm
PIER03	27,5	18,5	13,5	2,97	17 x 17 cm

PIEDRAS DE PARRILLA

Para cocinar finas rebanadas de carne, pescado, verduras o frutas. Piedra puede calentarse en el horno (300°C max).

Esteaftita natural

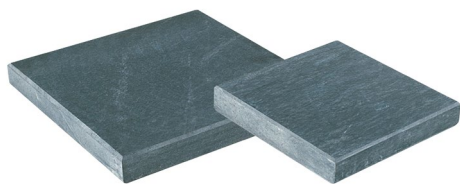
LOUIS TELLIER

Réf.	↔	↗	⊥	📦	🔍	📎
PIER17	17	17	3	2,3	17 x 17 cm	SUP03
PIER25	25	25	3	4,8	25 x 25 cm	SUP01

SOPORTE PARA PIEDRA DE PARRILLA

Soporte de piedra para hornear en alambre de acero. Quemador no incluido.

Alambre de acero cromado, mango de madera

LOUIS TELLIER

Réf.	↔	↗	⊥	📦	🔍	📎
SUP01	35,5	26,5	13,5	0,54	Para piedra 25 x 25 cm	PIER25
SUP03	27,5	18,5	13,5	0,48	Para piedra 17 x 17 cm	PIER17

PINZA PARA PIEDRAS DE PARRILLA

Abierta de la pinza: 30 mm. Para manejar las piedras parrillas por la salida del horno.

Acero inoxidable



Réf.	↔	↗	⊥	📦	🔍	📎
PIER-P	21,5	6,5	3,5	0,15	PIER01 / PIER03 / PIER25 / PIER17	

PORTA-BROCHETAS 2 PLAZAS

Acero inoxidable

LOUIS TELLIER

Réf.	∅	⊥	📦	🔍	📎
NC052	22	45	0,5		Con 2 brochetas
NC4250060	22	45	0,46		Sin brocheta

PORTA-BROCHETAS 4 PLAZAS

Acero inoxidable

LOUIS TELLIER

Réf.	∅	⊥	📦	🔍	📎
NC4250460	22	45	0,5		Sin brocheta

PORTABROCHETA DE HIERRO FORJADO CON BASE DE MADERA

Hasta 2 brochetas max 40 cm. Posibilidad de colocar un plato en la base de madera: taco de plato ∅ max 22 cm, plato ∅ 30 cm max. Se vende sin brocheta.

Hierro forjado, bandeja de madera

LOUIS TELLIER

Réf.	↔	↗	⊥	📦	🔍	📎
POBN01	31	27	43	1,06	Por unidad	PIC25 / PIC30 / PIC35 / PIC40
POBN01V	31	27	43	6,39	Lote de 6 a granel	

PORTA-BROCHETAS DE INOX CON BASE DE MADERA

Hasta 2 brochetas max 40 cm. Posibilidad de colocar un plato en la base de madera: taco de plato Ø max 22 cm, plato Ø 30 cm max. Se vende sin brocheta.

 Acero inoxidable, bandeja de madera



Ref.	↔	↗	⏊	📦	🔍	📎
POBX01	31	27	43	0,91	Por unidad	PIC25 / PIC30 / PIC35 / PIC40
POBX01V				0,82	Lote de 6 a granel	

PORTA-BROCHETAS DE INOX CON BASE Y SOPORTES DE SALSA

Hasta 2 brochetas max 40 cm. Posibilidad de colocar un plato en la base de madera: taco de plato Ø max 22 cm, plato Ø 30 cm max. Se vende sin brocheta. Ø dentro de los soportes de 9 cm.

 2 soportes para salsas

 Acero inoxidable, bandeja de madera



Ref.	↔	↗	⏊	📦
POBX01-S	31	27	43	0,96

PORTA-BROCHETAS MEDIEVAL HIERRO FORJADO

Para 1 brocheta espada. Se vende sin brocheta.

 Metal



Ref.	↔	↗	⏊	📦	🔍	📎
POBE01	31	26	43	0,85	Base de metal	BROCH02
POBE02	31	27	44	0,98	Base de madera	BROCH02

PORTA-BROCHETAS MEDIEVAL DE INOX - FIJACIÓN CÉNTRICA

Porta-brochetas medieval de acero inoxidable, soporte con mástil descentrado para levantar las brochetas.

 4 brochetas BROCH02 y 4 moldes de acero inoxidable

 Acero inoxidable, bandeja de madera vernizado



Ref.	∅	⏊	📦
POBX4C	21	54	1,41

PORTA-BROCHETAS MEDIEVAL DE INOX - FIJACIÓN ALTA

Porta-brochetas medieval de acero inoxidable, soporte con mástil descentrado para levantar las brochetas.

 4 brochetas BROCH02

 Acero inoxidable, bandeja de madera vernizado, aluminio



Ref.	∅	⏊	📦
POBX4D	26,5	58,5	1,48

PORTA-BROCHETAS DE PLATO CON BROCHETAS (LOTE DE 6)

Para una presentación original en el plato, con uno o más brochetas sobre soportes de clip.

 6 brochetas de 25 cm

 Acero inoxidable



Ref.	↔	↗	⏊	📦
PBC06C	24	20,5	5	0,19

PÓRTICO DE BROCHETAS

El soporte de brochetas está fijado a la base con imanes en ambos lados: estabilidad. Servicio de brochetas vertical en una tabla: limpieza e higiene. Permite el servicio de mesa individual. Emplazamientos para 5 brochetas de 25 cm max. Se vende sin brocheta y ramequín.

- Canal y pies magnéticos
- Acero inoxidable y madera



Réf.						
PORT01	46	12	28,5	0,61	Base de madera	PIC25
PORT02	46	12	27	0,49	Base papperstone®	PIC25

BROCHETA MEDIEVAL ESTILO ESPADA

Longitud útil: 35 cm.

- Acero inoxidable y aluminio

LOUIS TELLIER

Réf.					
BROCH02	47	8	1	0,13	POBE01 / POBE02 / POBX4C / POBX4D

BROCHETA GIGANTE

Longitud útil: 38 cm.

- Acero inoxidable



Réf.			
BROCH01-G	50	0,1	POBF01-G

AHUMADERO EN FRÍO

Para: pescados (salmón, trucha, anguila...), verduras, crustáceos, magret, aves de corral, salchichones, quesos...

- Rejilla 600x400
- Acero inoxidable

LOUIS TELLIER

Réf.					
FAFR	75	42	17,6	15	Con resistencia
FAF	75	42	17,6	15	Sin resistencia

RESISTENCIA ENCEDEDOR DE ASERRÍN

¡Combinando aserrín en un tiempo récord! (5 minutos son suficientes) Adaptada al ahumadero frío (FAF): su finura le permite deslizarse en el tanque de aserrín y no dejar escapar el humo.

- Temporizador de 30 minutos
- Aparato de acero inoxidable
- 150 W

LOUIS TELLIER

Réf.				
FAF01	39,5	7	12	FAF

AHUMADERO EN FRÍO



El ahumadero en frío es ideal para eliminar el agua de los productos (pescado, verduras, mariscos, pechuga de pato, aves, embutidos, quesos, etc.) sin secarlos.

Dos modelos disponibles : con y sin resistencia.



ANTIADHERENTE

BANDEJAS DE COCCIÓN	181
MOLDES DE PAN Y BANDEJAS DE HORNEAR	184
BANDEJAS DE PIZZA Y MOLDE DE HORNO	186
MOLDES PLEGABLES PARA PATE	187
MOLDES CAKE	188
BRIOCHE	189
MOLDES PARA TARTAS Y PASTELES	191
MOLDES MANQUE Y MILLASSON	198
MOLDES PARA GENOISE	200
MOLDES PARA SAVARIN, CHARLOTTE Y MÓDULOS TEMÁTICOS	201
MONOPORCIONES Y PASTELES	204
RECETAS Y PAQUETES DE KITS	207
PLACAS MÚLTIPLES PARA HORNEAR	209

FRANCE 1887
GOBEL[®]

rien ne remplace le fait main



LA ANTIADHERENTE

«LA FACILIDAD»

DESMOLDADO FÁCIL Y RÁPIDO

- Sin materia grasa, desmoldado perfecto
- Revestimiento antiadherente bicapa, garantizado sin PFOA, calidad profesional

EXCELENTE DIFUSIÓN DEL CALOR

- Cocción impecable y uniforme
- Buena conducción gracias a su material de acero revestido antiadherente

RESISTE A LAS TEMPERATURAS ELEVADAS

- Temperatura de calentado de hasta 250°C
- Espesor del molde de 0,5 mm : mejor compromiso entre la solidez y las calidades de cocción



EL CONSEJO DEL CHEF

Para conservar un producto antiadherente de calidad, deben evitarse los arañazos. Por eso debe optarse por cortar la preparación fuera del molde.

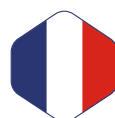

Made in France



MANTENIMIENTO

- Lavar el producto antes de usarlo por primera vez.
- Optar prioritariamente por el lavado a mano.
- Lavar con agua y jabón.

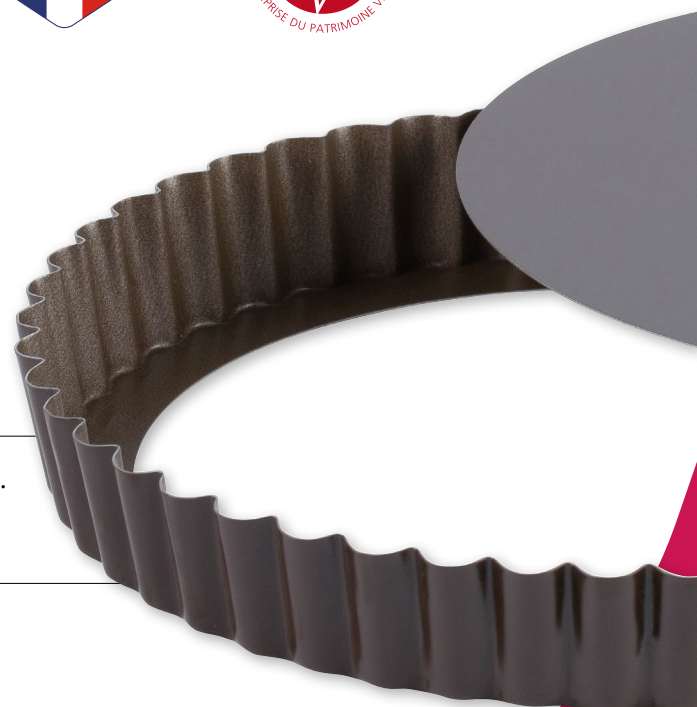





BANDEJA PARA 6 MAGDALENAS XXL

Para magdalenas XXL. Cavidad : 106 x 66 mm.

 Antiadherente

GOBEL





Réf.					
264810	39,5	20	1,7	0,4	5/10

BANDEJA DE 12 MAGDALENAS

Bordes redondos. Cavidades : prof. 8 mm.

 Antiadherente

GOBEL





Réf.					
264710	39,5	20	1,7	0,4	5/10

BANDEJA DE 20 MINI MAGDALENAS

Huella prof. 42 mm - bordes redondos.

 Antiadherente

GOBEL





Réf.					
264510	39,5	12,5	1,3	0,23	5/10

BANDEJA PARA 12 MUFFINS

Borde redondo. Cavidad : 67 x 67 x 30 mm.

 Antiadherente





GOBEL

Réf.					
296513	35,5	27,2	3,4	0,45	5/10

BANDEJA PARA 8 «ÉCLAIRS»

8 piezas a la vez. Ideal para aperitivos festivos o para el té o el café de la tarde.
8 huellas: 12 x 35 x 4,8 mm Antiadherente

GOBEL





Réf.					
298510	31,5	22,8	0,5	0,93	5/10

BANDEJA PARA 6 FINANCIEROS

Embutida - 6 moldes: 98 x 48 mm

 Antiadherente

GOBEL

Réf.					
220710	38	18	1,3	0,31	5/10

BANDEJA PARA 12 MINI FINANCIEROS O «PASTELES ROSES DE REIMS»

Embutida - 2 lneas de 6 moldes de 7,5 mm

Antiadherente

GOBEL

Réf.					
267030	29	19,8	1,7	0,31	5/10

BANDEJA PARA 12 MINI BARQUITAS

¡12 mini barquitas en un lote! Ideal para aperitivos festivos y cafés acompañados de dulces.

Antiadherente

GOBEL

Réf.					
298410	32	23,5	0,5	0,33	5/10

BANDEJA 12 MINI TARTALETAS

12 cavidades : Ø 8 mm. Fácil de desmoldar.

Antiadherente

GOBEL

Réf.					
228310	32	24,5	1	0,35	5/10

EMPUJADOR DE TARTATELAS

Madera de haya

GOBEL

Réf.				
319110	4/5,5	7	0,04	228310 / 293610 / 293620

PLACA PLISADA «DIENTES DE LOBO»

Cuenta 20 galletas por bandeja. Fácil de desmoldar.

Antiadherente

GOBEL

Réf.					
220510	30	29	2,5	0,62	5/10

PLACA DE AZULEJOS CONVEXA

Fácil de desmoldar.

Antiadherente

GOBEL

Réf.				
258130	35	24	0,62	5/10







MOLDE BRAZO GITANO

Embutido - bordeado

 Antiadherente



GOBEL

Réf.						
221110	37	27	2,1	0,53	Plazos de entrega : 5 semanas	5/10

ANTIADHERENTE

BANDEJA PARA PAN «FICELLE»





Fácil de desmoldar. 4 impresiones.

 Antiadherente



GOBEL



Réf.				
258230	35	24	0,55	5/10

BANDEJA PARA 4 PANES «BAGUETTE»





Fácil de desmoldar. 4 impresiones.

 Antiadherente



GOBEL



Réf.					
258330	38	32	2,7	0,62	5/10

BANDEJA PARA 2 PANES «BAGUETTE»





Fácil de desmoldar. 2 impresiones.

 Antiadherente



GOBEL



Réf.					
258320	38	16	2,2	0,3	5/10

BANDEJA PERFORADA PARA PAN «BAGUETTE»





Fácil desmoldeo. Las perforaciones promueven la circulación de aire caliente y permiten que escape el exceso de humedad para una cocción uniforme y una corteza crujiente.

 Antiadherente

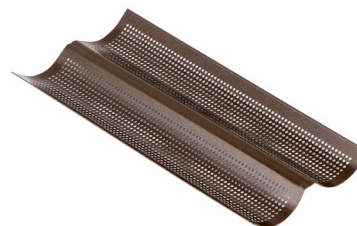

GOBEL



Réf.					
258321	38	16	2,2	0,3	5/10

BANDEJA 2 BARRAS DE PAN





Fácil de desmoldar. 2 impresiones.

 Antiadherente



GOBEL



Réf.				
258430	38	21	0,41	5/10

BANDEJA MINI-HAMBURGUESAS





Ideal para mini hamburguesas, blinis, mini-cookies, macarrones, etc. 18 cavidades Ø 4 mm A 5 mm

 Antiadherente



GOBEL



Réf.					
298610	34,5	18	0,5	0,25	5/10

ANTIADHERENTE

MOLDE PARA PANES HAMBURGUESAS

Fácil de desmoldar.

 Antiadherente



GOBEL

Réf.	∅	h	Peso	> <
210910	10	2	0,06	5/10

CAJA DE 4 MOLDES PARA PANES HAMBURGUESAS

 Antiadherente



GOBEL 

Réf.	∅	h	Peso	> <
282580	12	9	0,26	5/10

MOLDE PARA PAN PERFORADO

Fácil desmoldeo. Las perforaciones promueven la circulación de aire caliente y permiten que escape el exceso de humedad para una cocción uniforme y una corteza crujiente.

 Antiadherente



GOBEL 

Réf.	∅	L	h	Peso	> <
223690	27/25	10,5/8	8	0,35	5/10
234010	16/14	10/8	7	0,22	5/10

MOLDE PARA PAN REDONDO

Fácil de desmoldar.

 Antiadherente



GOBEL

Réf.	∅	h	Peso	> <
235010	23/20	6	0,31	5/10
235020	27/23,5	6	0,38	5/10

MOLDE PARA PAN DE MOLDE CON TAPA

Fácil de desmoldar.

 Antiadherente



GOBEL

Réf.	L	h	Peso	> <	
219010	40/39,5	10,5/10	9	1,1	5/10
219310	25/24,5	9,3/8,4	7,6	0,63	5/10

MOLDE PARA CLUB SANDWICH - PAN SORPRESA

Fácil de desmoldar.

 Antiadherente



GOBEL

Réf.	L	h	Peso	> <	
219050	20	20	19	1	5/10

MOLDE PARA PIZZA GOBEL

Antiadherente

GOBEL

Réf.	∅	h	Peso	> <
227005	15,5/14,7	1,2	0,12	5/10
227010	24/23	1,3	0,24	5/10
227020	30/29	1,3	0,35	5/10
227030	34/33	1,3	0,42	5/10

BANDEJA PARA PIZZA PERFORADA CON PIES GOBEL

Las perforaciones promueven la circulación de aire caliente y permiten que escape el exceso de humedad para una cocción uniforme.

Antiadherente

GOBEL

Réf.	∅	h	Peso	> <
227120	30/29	1,5	0,34	5/10
227130	34/33	1,5	0,42	5/10

MOLDE DE HORNO PEQUEÑO

Antiadherente

GOBEL

Réf.	L	l	h	Peso	> <
231010	24,5	18,5	4,5	0,33	5/10

PLATO DE ASAR

Antiadherente

GOBEL

Réf.	L	l	h	Peso	> <
231020	32	22	5	0,49	5/10

MOLDE LARGO PARA PATÉ (MINI)

Desmoldeo fácil y práctico gracias a la bisagra y al fondo extraíble.

Antiadherente



GOBEL

Réf.					
219410	30	4	6	0,37	5/10
219440	50	4	6	0,57	5/10

MOLDE PARA PATÉ O CAKE PLEGABLE

Con bordes de alambre para mayor resistencia y durabilidad a lo largo del tiempo. Antiadherente de dos capas reforzado con cerámica.

Antiadherente



GOBEL

Réf.					
220010	24/22	9,5/8	7	0,35	5/10
220020	27/25	10/9	7,5	0,42	5/10
220030	30/28,5	10/9	7,5	0,46	5/10

MOLDE LARGO PARA PATÉ

Desmoldeo fácil y práctico gracias a la bisagra y al fondo extraíble.

Antiadherente



GOBEL

Réf.					
219710	30	8	8	0,53	5/10
219720	35	8	8	0,6	5/10
219730	40	8	8	0,67	5/10
219740	50	8	8	0,8	5/10

MOLDE CAKE ESTAMPADO

Embutido, bordeado. Fácil de desmoldar.

Antiadherente

GOBEL

Réf.					
223320	26/23	9,5/6,5	7,5	0,28	5/10
223330	28/25	10/7,5	7,5	0,31	5/10

MOLDE INDIVIDUAL PARA CAKE ESTAMPADO

Fácil de desmoldar.

Aluminio revestido antiadherente

GOBEL

Réf.					
722630	10	3,8	3,5	0,04	10/10

PACK DE 6 MOLDES INDIVIDUALES PARA CAKES

Aluminio revestido antiadherente

GOBEL

Réf.					
726630	13	7	8	0,19	10/10

MOLDE CAKE CURVADO BORDEADO EN ALAMBRE

Fácil de desmoldar.

Antiadherente

GOBEL

Réf.					
222630	10/9	4,5/3,2	4	0,05	5/10
223610	15/13	7/5	5,5	0,2	5/10
223620	18/15,7	8/5,7	6,5	0,2	5/10
223630	21/18,5	9/6,5	7	0,26	5/10
223640	24/21,5	9/6,5	7	0,4	5/10
223650	27/24,2	10,5/7,7	8	0,4	5/10
223660	30/27,2	10,5/7,7	8	0,4	5/10
223670	33/30,2	10,5/7,7	8	0,4	5/10
223680	36/33,2	10,5/7,7	8	0,46	5/10



BRIOCHE PEQUEÑA - 10 COSTADOS

Fondo liso.

 Antiadherente



GOBEL 

Réf.				
293730	7,5/4	3	0,03	5/10





BRIOCHE - GRANDES COSTADOS

Fondo liso.

 Antiadherente



GOBEL

Réf.				
223010	14/7,3	4,8	0,12	5/10
223020	16/8,3	5,5	0,15	5/10
223030	18/9,1	5,6	0,18	5/10
223040	20/9,7	7,5	0,24	5/10
223050	22/9,9	9	0,3	5/10
223060	24/10	10	0,35	5/10

BRIOCHE PEQUEÑA - 9 COSTADOS





Fondo liso.

 Antiadherente



GOBEL 



Réf.				
293710	6/2,8	2,5	0,03	5/10
293720	7/3,7	2,8	0,03	5/10

BRIOCHE - 10 COSTADOS





Fondo liso.

 Antiadherente



GOBEL 



Réf.				
293740	8/4	3,5	0,04	5/10
293750	9/4,5	3,5	0,04	5/10
293760	10/5,5	4	0,05	5/10
293770	11/5,5	4,2	0,06	5/10





PACK DE 6 MOLDES DE BRIOCHE PEQUEÑAS

Brioche Ø 80/40 A 32 mm

 Antiadherente



GOBEL

Réf.				
271641	17	3,6	8,5	0,22

DISPLAY VACIO PARA BRIOCHES PEQUEÑAS

Se ofrece para configurar 24 moldes para brioche.

 Papier



GOBEL



Réf.			
307139	26	20	36

MOLDE PARA TARTA



Antiadherente bicapa
de calidad profesional que proporciona
un desmoldado perfecto

Fondo móvil :
desmoldado fácil
al 100 %



Fondo perforado : **distribución homogénea** del calor, perfecto para preparaciones espesas

Desde 1887, el material antiadherente Gobel es célebre por :

- Su excelente poder antiadherente que resulta mucho más eficiente que un material monocapa y proporciona un desmoldado perfecto.
- Su excelente resistencia a la abrasión, ya que el acabado bicapa permite cargar la capa superior de mica haciendo que resulte menos frágil.
- Su durabilidad : un mayor espesor del revestimiento le proporciona una mayor durabilidad.

TORTIERA REDONDA ACANALADA CON BORDE PLANO

Fondo fijo. Cocción homogénea.

 Antiadherente



GOBEL

Réf.	∅	I	📦	> <
226120	26/23	3	0,3	5/10

TORTIERA REDONDA ACANALADA

Fondo fijo. Cocción homogénea.

 Antiadherente



GOBEL

Réf.	∅	I	📦	> <
226320	20/18,5	2,8	0,17	5/10
226322	22/20	2,5	0,22	5/10
226330	24/23	2,8	0,25	5/10
226332	26/24	2,5	0,29	5/10
226340	28/27	2,8	0,33	5/10
226342	30/28	2,5	0,37	5/10
226350	32/31	2,5	0,42	5/10

TORTIERA REDONDA ACANALADA - FONDO MÓVIL

Fondo móvil.

 Antiadherente



GOBEL

Réf.	∅	I	📦	> <
226420	20/18,5	2,5	0,19	5/10
226422	22/20	2,5	0,22	5/10
226430	24/23	2,8	0,26	5/10
226432	26/24	2,5	0,3	5/10
226440	28/27	2,8	0,35	5/10
226442	30/28	2,5	0,38	5/10
226450	32/31	2,8	0,43	5/10

TORTIERA REDONDA ACANALADA ALTA

Fondo fijo. Cocción homogénea.

 Antiadherente



GOBEL

Réf.	∅	I	📦	> <
226520	20/18,5	3,5	0,2	5/10
226522	22/20	3,5	0,24	5/10
226530	24/22,5	3,5	0,27	5/10
226532	26/24	3,5	0,31	5/10
226540	28/26,5	3,5	0,34	5/10
226542	30/28	3,5	0,4	5/10
226550	32/30,5	3,5	0,42	5/10

ANTIADHERENTE

TORTIERA ACANALADA PERFORADA

Fondo fijo. Cocción homogénea.

Antiadherente

GOBEL

Réf.	∅	I	Ⓛ	> <
226321	20	2,5	0,17	5/10
226325	22	2,5	0,22	5/10
226331	24	2,5	0,25	5/10
226335	26	2,5	0,27	5/10
226341	28	2,5	0,31	5/10
226345	30	2,5	0,35	5/10
226351	32	2,5	0,39	5/10

TORTIERA REDONDA ACANALADA PERFORADA ALTA

Fácil de desmoldar.

Antiadherente

GOBEL

Réf.	∅	I	Ⓛ	> <
226521	20	3,5	0,2	5/10
226531	24	3,5	0,27	5/10
226541	28,5	3,5	0,34	5/10

TORTIERA REDONDA ACANALADA ALTA - FONDO MÓVIL

Desmoldeo fácil y práctico gracias al fondo móvil.

Antiadherente

GOBEL

Réf.	∅	I	Ⓛ	> <
226620	20/18,5	3,5	0,18	5/10
226622	22/20	3,5	0,26	5/10
226630	24/22,5	3,5	0,26	5/10
226632	26/24	3,5	0,33	5/10
226640	28/26,5	3,5	0,37	5/10
226642	30/28	3,5	0,43	5/10
226650	32/30,5	3,5	0,47	5/10

TORTIERA REDONDA ACANALADA PERFORADA - FONDO MÓVIL

Desmoldeo fácil y práctico gracias al fondo móvil.

Antiadherente

GOBEL

Réf.	∅	I	Ⓛ	> <
226421	20	2,5	0,19	5/10
226425	22	2,5	0,22	5/10
226431	24	2,5	0,26	5/10
226435	26	2,5	0,3	5/10
226441	28	2,5	0,35	5/10
226445	30	2,5	0,38	5/10
226451	32	2,5	0,43	5/10

TORTIERA REDONDA LISA

Fácil de desmoldar.

 Antiadherente



GOBEL

Réf.	∅	I	Ⓛ	> <
227310	12/10,5	2,5	0,08	5/10
227330	24/22,5	2,5	0,25	5/10
227340	28/26,5	2,5	0,34	5/10
227350	32/30,5	2,5	0,43	5/10

TARTA DE FRUTAS FRESCAS - ACANALADA

Fácil de desmoldar. Fondo elevado

 Antiadherente



GOBEL

Réf.	∅	I	> <
226950	28	3,5	5/10

PACK DE 6 TARTELETAS DE FRUTAS FRESCAS ACANALADA

Fácil de desmoldar. Fondo elevado

 Antiadherente



GOBEL

Réf.	∅	I	Ⓛ	> <
295790	10/8,4	1,8	0,31	5/10

TORTIERA REDONDA LISA ALTA - FONDO MÓVIL

Desmoldeo fácil y práctico gracias al fondo móvil.

 Antiadherente



GOBEL

Réf.	∅	I	Ⓛ	> <
223801	10/9	3	0,07	5/10
223822	18/15,3	4,5	0,2	5/10

TARTELETA DE FRUTAS FRESCAS ACANALADA

Fácil de desmoldar. Fondo elevado

 Antiadherente



GOBEL

Réf.	∅	I	Ⓛ	> <
295770	10/8,4	2	0,08	5/10

TARTELETA REDONDA ACANALADA - FONDO MÓVIL

Desmoldeo fácil y práctico gracias al fondo móvil.

 Antiadherente



GOBEL

Réf.	∅	I	Ⓛ	> <
293470	10/8,5	1,8	0,05	5/10
293472	11/9	2	0,07	5/10
293480	12/11	2	0,08	5/10
293490	14/13	2,5	0,11	5/10

TARTELETA REDONDA ACANALADA

Fácil de desmoldar.

Antiadherente

GOBEL

Réf.	∅	I	Peso	> <
293520	5/4	1	0,01	5/10
293530	6/5	1	0,02	5/10
293540	7/6	1	0,02	5/10
293550	8/7	1	0,03	5/10
293560	9/7,5	1,5	0,04	5/10
293570	10/8,5	2	0,04	5/10
293572	11/9	2	0,06	5/10
293580	12/11	2	0,07	5/10
293590	14/13	2,5	0,09	5/10

PACK DE 6 TARTELETAS REDONDAS ACANALADAS Ø100 MM

Fácil de desmoldar.

Antiadherente

GOBEL

Réf.	∅	I	Peso	> <
270171	10/8,5	1,8	0,26	5/10

PACK DE 6 TARTELETAS REDONDAS ACANALADAS Ø 120 MM

Fácil de desmoldar.

Antiadherente

GOBEL

Réf.	∅	I	Peso	> <
282550	12/11	2	0,43	5/10

TARTELETA REDONDA LISA

Fácil de desmoldar.

Antiadherente

GOBEL

Réf.	∅	I	Peso	> <
293630	5/3	1,1	0,01	5/10
293640	6/3,8	1,2	0,02	5/10
293650	7/4,8	1,2	0,02	5/10
293660	8/5,8	1,5	0,03	5/10
293670	9/6,8	1,5	0,03	5/10
293680	10/7,8	1,5	0,04	5/10

PACK DE 6 TARTELETAS REDONDAS ACANALADAS

Fácil de desmoldar.

Antiadherente

GOBEL

Réf.	∅	I	Peso	> <
282540	10/8,5	1,8	0,3	5/10

PACK DE 6 TARTELETAS REDONDAS ACANALADAS Ø 80 MM

Fácil de desmoldar.

Antiadherente

GOBEL

Réf.	∅	I	Peso	> <
282560	8/7	1,2	0,32	5/10

MOLDE TARTA MEDIA BORDES ACANALADAS

Fácil de desmoldar.

Antiadherente



GOBEL



Réf.	∅	I	⊞	🔍	> <
227840	28	2	0,2	Bordes rizados	5/10

MOLDE TARTA MEDIA BORDES LISOS

Fácil de desmoldar.

Antiadherente



GOBEL



Réf.	∅	I	⊞	🔍	> <
227845	28	2	0,22	Bordes lisos	5/10

TARTA ACANALADA CASERA - FONDO FIJO

Fácil de desmoldar.

Antiadherente



GOBEL



Réf.	↔	↗	I	⊞	> <
225310	35/34	11/10	2,5	0,24	5/10

TARTA ACANALADA CASERA - FONDO MÓVIL

Desmoldeo fácil y práctico gracias al fondo móvil.

Antiadherente



GOBEL



Réf.	↔	↗	I	⊞	> <
225410	35/34	11/10	2,5	0,26	5/10

TARTA ACANALADA CASERA PERFORADA - FONDO FIJO

Desmoldeo fácil y práctico gracias al fondo móvil.

Antiadherente



GOBEL



Réf.	↔	↗	I	⊞	> <
225412	35/34	11/10	2,5	0,25	5/10

TARTA RECTANGULAR ACANALADA - FONDO FIJO

Fácil de desmoldar.

Antiadherente



GOBEL



Réf.	↔	↗	I	⊞	> <
225710	29/27,5	20,5/19,5	2,5	0,46	5/10

ANTIADHERENTE

TARTA RECTANGULAR ACANALADA - FONDO MÓVIL

Desmoldeo fácil y práctico gracias al fondo móvil.

 Antiadherente



GOBEL

Réf.					
225810	29/27,5	20,5/19,5	2,5	0,43	5/10

TARTELETA RECTANGULAR ACANALADA - FONDO FIJO

Fácil de desmoldar.

 Antiadherente



GOBEL

Réf.					
295130	12/11,2	7,5/6,6	2	0,06	5/10

TARTELETA RECTANGULAR ACANALADA - FONDO MÓVIL

Desmoldeo fácil y práctico gracias al fondo móvil.

 Antiadherente



GOBEL

Réf.					
295330	12/11,2	7,5/6,6	2	0,07	5/10

PACK DE 6 TARTELETAS RECTANGULARES ACANALADAS - FONDO MÓVIL

Desmoldeo fácil y práctico gracias al fondo móvil.

 Antiadherente



GOBEL

Réf.						
291870	12/11,2	7,5/6,6	2	0,5	Fondo móvil	5/10

PACK DE 6 TARTELETAS RECTANGULARES ACANALADAS - FONDO FIJO

Fácil de desmoldar.

 Antiadherente



GOBEL

Réf.						
295376	12/11,2	7,5/6,6	2	0,4	Fondo fijo	5/10

TARTA CUADRADA RIZADA - FONDO FIJO

Fácil de desmoldar.

 Antiadherente

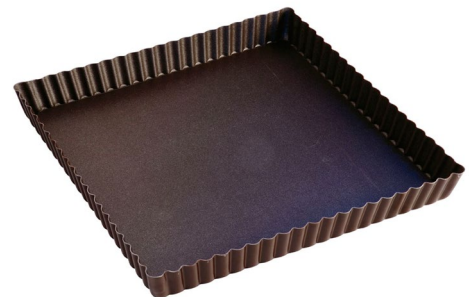

GOBEL

Réf.					
226710	23/22	23/22	2,5	0,36	5/10

ANTIADHERENTE

TARTA CUADRADA RIZADA - FONDO MÓVIL

Desmoldeo fácil y práctico gracias al fondo móvil.

 Antiadherente



GOBEL

Réf.					
226810	23/22	23/22	2,5	0,37	5/10

TARTA ACANALADA CASERA - FONDO FIJO

Fácil de desmoldar.

 Antiadherente



GOBEL

Réf.					
294370	10/9	10/9	2	0,06	5/10

TARTELETA CUADRADA ACANALADA - FONDO MÓVIL

Desmoldeo fácil y práctico gracias al fondo móvil.

 Antiadherente



GOBEL

Réf.					
294470	10/9	10/9	2	0,07	5/10

PACK DE 6 TARTELETAS CUADRADAS ACANALADA - FONDO FIJO

Fácil de desmoldar.

 Antiadherente



GOBEL

Réf.						
294376	10/9	10/9	2	0,37	Fondo fijo	5/10

PACK DE 6 TARTELETAS CUADRADAS ACANALADA - FONDO MÓVIL

Desmoldeo fácil y práctico gracias al fondo móvil.

 Antiadherente



GOBEL

Réf.						
294476	10/9	10/9	2	0,46	Fondo móvil	5/10

PACK DE 6 MOLDES «MILLASSONS»

Bordeado. Fácil de desmoldar.

Antiadherente

GOBEL

Réf.	∅	I	Peso	> <
282570	10/9	2,1	0,36	5/10

MOLDE «MILLASSON»

Bordeado. Fácil de desmoldar.

Antiadherente

GOBEL

Réf.	∅	I	Peso	> <
293250	6/5	2	0,02	5/10
293270	8/6,8	2	0,04	5/10
293280	9/7,8	2	0,04	5/10
293290	10/9	2	0,06	5/10

MOLDE «MANQUÉ» REDONDO LISO

Bordeado. Antiadherente de dos capas reforzado con cerámica. Fácil de desmoldar.

Antiadherente

GOBEL

Réf.	∅	I	Peso	> <
223701	10/9	3	0,07	5/10
223702	12/10,5	3,4	0,09	5/10
223705	14/11,7	3,5	0,12	5/10
223710	16/13,6	4	0,15	5/10
223720	18/15,3	4,5	0,18	5/10
223730	20/17,5	4,5	0,23	5/10
223740	22/19,5	5	0,27	5/10
223750	24/10	5	0,29	5/10
223760	26/23,5	5	0,27	5/10
223770	28/25	5	0,39	5/10
223780	30/27,5	5,5	0,46	5/10
223790	32/29,5	5,5	0,51	5/10

MOLDE «MANQUÉ» ROSETA

Bordeado. Fácil de desmoldar.

Antiadherente

GOBEL

Réf.	∅	I	Peso	> <
222130	20/17,5	5	0,23	5/10

MOLDE «MANQUÉ» REDONDO RIZADO - FONDO MÓVIL

Acanalado fino. Desmoldeo fácil y práctico gracias al fondo móvil.

 Antiadherente



GOBEL

Réf.	∅	I	Peso	> <
224810	10/8	3	0,07	5/10
224820	15/13	4	0,14	5/10

MOLDE FLANERO PERFORADO - FONDO MÓVIL

Ideal para flanes y generosos pasteles salados. Fondo móvil perforado: elimina el exceso de humedad de la crema y las preparaciones ricas en agua (verduras) para una mejor cocción de la masa. Desmoldeo fácil. Borde derecho. Bordeado.

 Antiadherente



GOBEL

Réf.	∅	I	Peso	> <
252660	27	4,5	0,44	5/10

«MANQUÉ» DESMONTABLE

1 inferior. Desmoldeo fácil y práctico gracias a la bisagra.

 Acero revestido antiadherente



Réf.	∅	I	Peso	> <
221640	22	7	0,27	3/10
221650	24	7	0,32	3/10
221660	26	7	0,35	3/10
221670	28	7	0,35	3/10
221680	30	7	0,38	3/10

«MANQUÉ» DESMONTABLE - 2 FONDOS

2 fondos: 1 plano + 1 acanalado con cilindro para savarin. Facil de desmoldar gracias a la bisagra.

 Antiadherente



GOBEL

Réf.	∅	I	Peso	> <
221750	24	7	0,39	3/10
221770	28	7	0,35	3/10

«MANQUÉ» CUADRADO

Borde reforzado con alambre. Fácil de desmoldar.

 Antiadherente



GOBEL

Réf.	L	l	I	Peso	> <
224101	10/9	10/9	4	0,13	5/10
224110	22/20,5	22/20,5	5	0,43	5/10
224120	24/22,5	24/22,5	5	0,6	5/10

«MANQUÉ» CUADRADO - FONDO MÓVIL

Borde reforzado con alambre. Cómodo desmoldeo gracias al fondo móvil.

 Antiadherente



GOBEL

Réf.	L	l	I	Peso	> <
224210	22/20,5	22/20,5	5	0,52	5/10
224220	24/22,5	24/22,5	5	0,6	5/10

MOLDE PARA «GÉNOISE»

Borde redondo reforzado. Fácil de desmoldar.

Antiadherente

GOBEL

Ref.					
225100	30/30,8	20/20,8	3,5	0,46	5/10
225101	35/35,8	25/25,8	5	0,65	5/10
225105	35/35,8	25/25,8	3,5	0,6	5/10
225110	40/41,4	30/31,4	3,5	1,03	5/10
225120	51/52,4	36/37,5	5	1,52	5/10
255610	40/41,4	30/31,4	5	1,1	5/10

SAVARÍN ABIERTO

Abierto - embutido

Antiadherente



GOBEL

Réf.	Ø	I	P	> <
224040	22	4,5	0,26	5/10
224050	24	5	0,3	5/10

SAVARÍN ACANALADO «TROIS FRÈRES» ABIERTO

Cilindro abierto. Embutido. Savarin torcido, forma de corona. Ideal para ron baba y king cake.

Antiadherente



GOBEL

Réf.	Ø	I	P	> <
224340	22	5,5	0,36	5/10

SAVARÍN ABIERTO

Abierto - embutido. Fácil de desmoldar.

Antiadherente



GOBEL

Réf.	Ø	I	P	> <
254050	24	5,8	0,35	5/10
254060	26	6	0,41	5/10

SAVARÍN INDIVIDUAL CERRADO

Cilindro cerrado. Savarin, forma de corona. Ideal para ron baba y king cake.

Antiadherente



GOBEL

Réf.	Ø	I	P	> <
223930	8	2	0,04	5/10

SAVARÍN INDIVIDUAL ABIERTO

Cilindro abierto. Savarin, forma de corona. Ideal para ron baba y king cake.

Antiadherente



GOBEL

Réf.	Ø	I	P	> <
224030	8	2	0,04	5/10
224034	12	2,5	0,09	5/10

CAJA DE 6 SAVARINES INDIVIDUALES CERRADOS

6 savarines individuales, en forma de corona. Cilindro bloqueado.

Antiadherente



GOBEL

Réf.	Ø	L	I	P	> <
272710	17,3	3,7	8,5	0,25	5/10

MOLDE ALTO «SOUFFLÉ»

Antiadherente

GOBEL

Réf.	Ø	H	P	> <
210920	18	10	0,85	5/10

MOLDE «SOUFFLÉ» INDIVIDUAL

Cocción homogénea. Fácil de desmoldar.

Antiadherente

GOBEL

Réf.	Ø	H	P	> <
235110	8	5	0,06	5/10

CAJA DE 4 MOLDES «SOUFFLÉ» INDIVIDUALES

Antiadherente

GOBEL

Réf.	Ø	H	P	> <
282520	8	5	0,28	5/10

MOLDE «CHARLOTTE»

Embutido.

Antiadherente

GOBEL

Réf.	Ø	H	P	> <
212620	18/15	10	0,3	5/10

MOLDE CORAZÓN SAN VALENTÍN

Fondo fijo, bordeado. Fácil de desmoldar.

Antiadherente

GOBEL

Réf.	L	L	H	P	> <
255130	16	15	3,5	0,17	5/10

MOLDE CORAZÓN SAN VALENTÍN - FONDO MÓVIL

Fondo móvil, bordeado. Fácil de desmoldar.

Antiadherente

GOBEL

Réf.	L	L	H	P	> <
255230	16	15	3,5	0,2	5/10





PUDÍN DIPLOMÁTICO

Para galletas y jaleas. Embutido.

 Antiadherente



GOBEL

Réf.				
224610	18/15	9	0,26	5/10





KOUGLOF

Fácil de desmoldar.

 Antiadherente



GOBEL

Réf.				
228020	21	8	0,17	5/10





MOLDE BIZCOCHO DE QUESO

Fácil de desmoldar.

 Antiadherente



GOBEL

Réf.				
251210	14/7	4	0,11	5/10





MOLDE EMPANADA

Para hojaldres a base de queso, carne, verduras ...

 Antiadherente



GOBEL

Réf.					
293030	9,8/8,3	5,1/3,1	1,4	0,03	5/10

ANTIADHERENTE

PACK DE 60 «PETITS-FOURS»

5 ud/forma x 12 formas

Antiadherente

GOBEL

Réf.	∅	h	Peso	Paquetes
285201	12	4	0,47	5/10

«PETITS-FOURS»

Fácil de desmoldar.

Antiadherente

GOBEL

Réf.	h	l	∅	Peso	Forma	Paquetes	
291010	6	1		0,01	Rumbo liso	5/10	
291510	6	1		0,01	Barquillo «calisson»	5/10	
292010			5	1	0,01	Rectángulo liso	5/10
292510			3,5		0,01	Redondo alto	5/10
293510			4,5	1	0,01	Redondo rizado	5/10
293610			3,5	1	0,01	Tartaleta redonda lisa	5/10
293620			4	1	0,01	Tartaleta redonda lisa	5/10
294020	7	2,8	1		0,01	Tartaleta mini barquita lisa	5/10
295010	3,5	3,5	1		0,01	Cuadrado rizado	5/10
295510			4,5	1	0,01	Cúpula redonda rizada	5/10
296010			4,5	1	0,01	Ovalado rizado	5/10
296510			4,5	1	0,01	Cúpula ovalada rizada	5/10

PACK DE 30 «PETITS-FOURS»

6 ud/forma x 5 formas: redondo rizado + cuadrado rizado + barquillo Calisson + redondo liso + rumbo liso

Antiadherente

GOBEL

Réf.	∅	h	Peso	Paquetes
285400	12	3	0,24	5/10

BARQUITA LISA

Fácil de desmoldar.

Antiadherente

GOBEL

Réf.	h	l	∅	Peso	Paquetes
294010	6	2	1	0,01	5/10
294030	8	3,3	1,2	0,01	5/10
294040	9	4	1,2	0,01	5/10
294050	10	4,3	1,3	0,02	5/10
294060	11	4,6	1,3	0,02	5/10
294070	12	5	1,3	0,02	5/10





BARQUITA ACANALADA

Fácil de desmoldar.

 Antiadherente



GOBEL

Réf.					
294110	8	4	1,2	0,02	5/10
294120	9	4,3	1,2	0,02	5/10
294130	10	4,5	1,2	0,02	5/10
294140	11	4,7	1,3	0,02	5/10
294150	12	5	1,4	0,03	5/10

MOLDE ASPIC OVALADO CON FONDO ESTRELLA

Fácil de desmoldar.

 Antiadherente



GOBEL

Réf.					
230310	7,5	5,5	3,8	0,04	5/10





MOLDE ASPIC OVALADO CON FONDO LISO

Fácil de desmoldar.

 Antiadherente



GOBEL

Réf.					
230210	7,5	5,5	3,8	0,04	5/10

BLÍSTER DE 4 MOLDES OVALADOS CON FONDO LISO

Fácil de desmoldar.

 Antiadherente



GOBEL

Réf.					
271011	7,5	5,5	3,8	0,17	5/10

MOLDE PARA MUFFIN

Fácil de desmoldar

 Antiadherente



GOBEL

Réf.				
296511	7	3,5	0,02	5/10

CAJA DE 6 MOLDES PARA MUFFIN

Fácil de desmoldar.

 Antiadherente



GOBEL

Réf.					
296512	7,5	7,5	4	0,14	5/10

FLANERO REDONDO «DARIOLE»

Embutido, bordeado. Fácil de desmoldar.

Antiadherente

GOBEL

Réf.					
229810	6/4,8	6	0,05	5/10	

FLANERO ACANALADO «BORDELAIS»

Un resultado sabroso: bonita caramelización por fuera e interior esponjoso. Conducción térmica óptima del aluminio. Desmoldeado facilitado. Longevidad del revestimiento antiadherente 4 capas.

Aluminio revestido antiadherente

GOBEL

Réf.						
729510	3,5	3,5	0,01	S	10/10	
729520	4,5	4,3	0,02	M	10/10	
729530	5,5	5	0,02	L	10/10	

CAJA DE 6 FLANEROS ACANALADOS «BORDELAIS»

Un resultado sabroso : bonita caramelización por fuera y un interior suave. Conducción óptima del calor del aluminio. Fácil de desmoldar. Longevidad del revestimiento antiadherente de 4 capas. Tamaño del molde : 55 x 50 mm.

Aluminio revestido antiadherente

GOBEL

Réf.						
729540	13	8,5	7	0,14	10/10	

PACK RECETAS RON BABA

Ideal para animar y dinamizar el fondo de la estantería. Para resaltar producto, temático. Presente caja.

Antiadherente



GOBEL

Réf.	Ø	I	Peso	Descripción	Réf.
224050-PK	24	5	0,3	Cartón de 6 cajas. Para Savarin Ref. 224050 Ø24.	224050

PACK RECETAS TARTA DE LIMON

Ideal para animar y dinamizar el fondo de la estantería. Para resaltar producto, temático. Presente caja.

Antiadherente



GOBEL

Réf.	Ø	I	Peso	Descripción	Réf.
226340-PK	28/27	2,8	0,33	Cartón de 6 cajas. Para molde redondo acanalado Ref. 226340 Ø28.	226340

PACK RECETAS TARTE TATIN

Ideal para animar y dinamizar el fondo de la estantería. Para resaltar producto, temático. Presente caja.

Antiadherente



GOBEL

Réf.	Ø	I	Peso	Descripción	Réf.
223760-PK	26/23,5	5	0,27	Cartón de 6 cajas. Para molde «manqué» redondo liso. Ref. 223760 Ø 26.	223760

PACK RECETAS QUICHE DE LORENA

Ideal para animar y dinamizar el fondo de la estantería. Para resaltar producto, temático. Presente caja.

Antiadherente



GOBEL

Réf.	Ø	I	Peso	Descripción	Réf.
226120-PK	26/23	3	0,3	Cartón de 6 cajas. Para molde para pastel redondo con borde plano Ref. 226120 Ø26.	226120

KIT 1001 TARTAS

Contiene : 1 molde para tarta acanalado redondo Ø 28 cm, 6 moldes para tarta acanalado redondo Ø 10 cm, 1 pelador de manzanas de la marca La Bonne Graine para pelar, cortar y descorazonar manzanas rápidamente e ideas de recetas.

1 molde para tarta : antiadherente / 6 moldes antiadherente para tartaletas : antiadherente / pelador de manzanas : hierro fundido y pintado epoxy



GOBEL

Réf.	L	l	I	Peso
GL20P011	30	30	14,5	1,21

PLACAS MULTIPLES PARA HORNEAR



Acero revestido
antiadherente

Fácil de manipular :
ganancia de tiempo

Sólida : diseñada
para un uso intensivo



Adaptada a **los hornos**
y a las escaleras de **pastelería** :
se utiliza sin rejilla

Conducción térmica óptima :
menor tiempo de cocción y
ahorro de energía

ANTIADHERENTE



BANDEJA FLANERO ACANALADO «BORDELAIS»

Cavidades : Ø 55 mm H 50 mm. Apto para hornos y escaleras de pastelería: se puede utilizar sin rejilla. Para uso intensivo.

 Acero revestido antiadherente



GOBEL

Réf.					
299130	60	40	3,5	45 cavidades. Plazos de entrega : 5 semanas.	5/10

BANDEJA «MANQUÉ»

Cavidades : Ø 100 mm H 30 mm. Apto para hornos y escaleras de pastelería: se puede utilizar sin rejilla. Para uso intensivo.

 Acero revestido antiadherente



GOBEL

Réf.						
299101	60	40	3,5	2,38	14 cavidades. Plazos de entrega : 5 semanas.	5/10





BANDEJA «MILLASSON»

Apto para hornos y básculas de pastelería : se puede utilizar sin rejilla. Para uso intensivo.

 Acero revestido antiadherente



GOBEL

Réf.					
299102	60	40	3,5	18 cavidades Ø90 A19 mm. Plazos de entrega : 5 semanas.	5/10
299103	60	40	3,5	25 cavidades Ø80 A18 mm. Plazos de entrega : 5 semanas.	5/10

BANDEJA «DARIOLE»

Cavidades : Ø 60 mm H 60 mm. Apto para hornos y escaleras de pastelería: se puede utilizar sin rejilla. Para uso intensivo.

 Acero revestido antiadherente



GOBEL

Réf.					
299105	60	40	3,5	35 cavidades. Plazos de entrega : 5 semanas.	5/10

BANDEJA MAGDALENAS

Apto para hornos y básculas de pastelería : se puede utilizar sin rejilla. Para uso intensivo.

 Acero revestido antiadherente



GOBEL

Réf.						
299108	60	40	3	1,9	36 cavidades magdalenas. Plazos de entrega : 5 semanas.	5/10

BANDEJA MINI MAGDALENAS

Apto para hornos y básculas de pastelería : se puede utilizar sin rejilla. Para uso intensivo.

 Acero revestido antiadherente

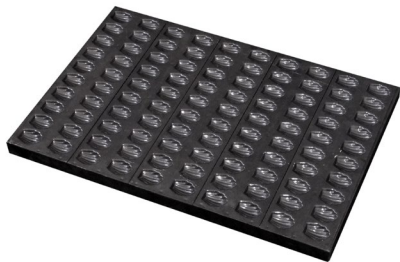

GOBEL

Réf.					
299109	60	40	3,5	100 cavidades mini magdalenas. Plazos de entrega : 5 semanas.	5/10

BANDEJA FINANCIEROS

24 financiers : 98 x 48 A 13 mm. Apto para hornos y escaleras de pastelería: se puede utilizar sin rejilla. Para uso intensivo.

Acero revestido antiadherente

GOBEL

Réf.						> <
299110	60	40	3	2,17	24 cavidades. Plazos de entrega : 5 semanas.	5/10

BANDEJA MUFFIN

Cavidades : Ø 70 mm H 35 mm. Apto para hornos y escaleras de pastelería: se puede utilizar sin rejilla. Para uso intensivo.

Acero revestido antiadherente

GOBEL

Réf.					> <
299104	60	40	3,5	33 cavidades. Plazos de entrega : 5 semanas.	5/10

BANDEJA SAVARÍN CERRADO

Cavidades : Ø 80 mm H 20 mm. Apto para hornos y escaleras de pastelería: se puede utilizar sin rejilla. Para uso intensivo.

Acero revestido antiadherente

GOBEL

Réf.						> <
299106	60	40	3,5	2,34	25 cavidades. Plazos de entrega : 5 semanas.	5/10

BANDEJA OVALADO

32 cavidades : A 38 mm. Apto para hornos y escaleras de pastelería: se puede utilizar sin rejilla. Para uso intensivo.

Acero revestido antiadherente

GOBEL

Réf.					> <
299107	60	40	3,5	32 cavidades. Plazos de entrega : 5 semanas.	5/10

BANDEJA MOLDES CON BORDES ALTOS

8 cavidades : Ø 100 mm A 30 mm

Acero revestido antiadherente

GOBEL

Réf.					> <
299201	53	32,5	3,5	8 cavidades. Plazos de entrega : 5 semanas.	5/10

BANDEJA «MILLASSON»

Apto para hornos y básculas de pastelería : se puede utilizar sin rejilla. Para uso intensivo.

Acero revestido antiadherente

GOBEL

Réf.					> <
299202	53	32,5	3,5	15 moldes Ø80 A18 mm. Plazos de entrega : 5 semanas.	5/10
299203	53	32,5	3,5	24 cavidades Ø90 A19 mm. Plazos de entrega : 5 semanas.	5/10

BANDEJA FLANEROS «DARIOLE»

Cavidades : Ø 60 mm H 60 mm. Apto para hornos y escaleras de pastelería: se puede utilizar sin rejilla. Para uso intensivo.

Acero revestido antiadherente



GOBEL

Réf.				> <
299205	53 32,5 3,5	24 cavidades. Plazos de entrega : 5 semanas.		5/10

BANDEJA FLANEROS ACANALADO «BORDELAIS»

Cavidades : Ø 55 mm H 50 mm. Apto para hornos y escaleras de pastelería: se puede utilizar sin rejilla. Para uso intensivo.

Acero revestido antiadherente



GOBEL

Réf.				> <
299230	53 32,5 3,5	32 cavidades. Plazos de entrega : 5 semanas.		5/10

BANDEJA MUFFIN

Cavidades : Ø 70 mm H 35 mm. Apto para hornos y escaleras de pastelería: se puede utilizar sin rejilla. Para uso intensivo.

Acero revestido antiadherente



GOBEL

Réf.				> <
299204	53 32,5 3,5	15 cavidades. Plazos de entrega : 5 semanas.		5/10

BANDEJA SAVARÍN CERRADO

Cavidades : Ø 80 mm H 20 mm. Apto para hornos y escaleras de pastelería: se puede utilizar sin rejilla. Para uso intensivo.

Acero revestido antiadherente



GOBEL

Réf.				> <
299206	53 32,5 3,5	15 cavidades. Plazos de entrega : 5 semanas.		5/10

PANES HAMBURGUESA

8 cavidades : Ø 100 mm A 20 mm. Foto no contractual.

Acero revestido antiadherente



GOBEL

Réf.				> <
299220	53 32,5 3,5	8 cavidades. Plazos de entrega : 5 semanas.		5/10

ANTIADHERENTE



ANTIADHERENTE OBSIDIAN



BANDEJAS Y MOLDES OBSIDIAN

215



OBSIDIAN

EL ANTIADHERENTE CON UNA GARANTÍA DE 10 AÑOS

«LA DURABILIDAD»

Nuevo revestimiento «bicapa» reforzado con cerámica cuyo espesor se incrementa un 20 %

RESISTENCIA EXTREMA A LO LARGO DEL TIEMPO

- Garantía de 10 años
- Para una frecuencia de uso continua y una antiadherencia excepcional

DESMOLDADO FÁCIL Y RÁPIDO

- Sin materia grasa, desmoldado perfecto
- Revestimiento antiadherente, garantizado sin PFOA, calidad profesional
- Cumplimiento de las normas REACH

CONTROL DE LA CAMELIZACIÓN

- Para proporcionar una coloración de precisión
- Tenaz frente al azúcar y a la mermelada



EL CONSEJO DEL CHEF

Este producto antiadherente, ideal para usar en pastelería, se adapta también perfectamente a la preparación de recetas saladas.

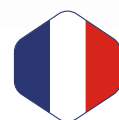

Made in France



MANTENIMIENTO

- Lavar el producto antes de usarlo por primera vez.
- Optar prioritariamente por el lavado a mano.
- Lavar con agua y jabón.



Siempre atento a las innovaciones y al progreso técnico, Gobel ofrece en exclusiva la gama OBSIDIAN, lo último en tecnología de revestimientos, adecuada para un uso normal o intensivo.

La gama antiadherente OBSIDIAN GOBEL, garantizada durante 10 años, está fabricada con acero revestido de muy alta calidad, cuyo grosor se ha incrementado en un 20 % en comparación con nuestras placas de acero históricas (es decir, 0,6 mm) para ofrecer una solidez aún mayor.

BANDEJA PARA 6 MAGDALENAS

Para magdalenas XXL. Borde redondo. Cavidad : 106 x 66 mm. Material un 20% más grueso para mayor resistencia y durabilidad. Un 20% más de antiadherente para un perfecto control de la caramelización.

Acero revestido antiadherente Obsidian



GOBEL

Réf.					
464810	39,5	22,7	2	0,47	6/10

BANDEJA DE 12 MAGDALENAS

Borde redondo. Cavidad : 80 mm. Material un 20% más grueso para mayor resistencia y durabilidad. Un 20% más de antiadherente para un perfecto control de la caramelización.

Acero revestido antiadherente Obsidian



GOBEL

Réf.					
464710	39,5	20	1,7	0,47	6/10

BANDEJA DE 20 MINI MAGDALENAS

Borde redondo. Cavidad : 42 mm. Material un 20% más grueso para mayor resistencia y durabilidad. Un 20% más de antiadherente para un perfecto control de la caramelización.

Acero revestido antiadherente Obsidian



GOBEL

Réf.					
464510	39,5	12,5	1,3	0,27	6/10

BANDEJA PARA 6 FINANCIEROS

Borde redondo. Material un 20% más grueso para mayor resistencia y durabilidad. Un 20% más de antiadherente para un perfecto control de la caramelización.

Acero revestido antiadherente Obsidian



GOBEL

Réf.				
420710	38	18		6/10

BANDEJA PERFORADA PARA 2 «BAGUETTES»

Material un 20% más grueso para mayor resistencia y durabilidad. Un 20% más de antiadherente para un perfecto control de la caramelización.

Acero revestido antiadherente Obsidian



GOBEL

Réf.					
458320	38	16,2	2	0,37	6/10

BANDEJA PERFORADA PARA 2 «BAGUETTES»

Material un 20% más grueso para mayor resistencia y durabilidad. Un 20% más de antiadherente para un perfecto control de la caramelización.

Acero revestido antiadherente Obsidian



GOBEL

Réf.					
458321	37,7	16	2	0,36	6/10

MOLDE DE BORDES ALTOS OBSIDIAN



Para un uso
frecuente

Acero un **20 % más grueso** =
+ sólido y + duradero



Perfecto control
de la caramelización, soporta
más el azúcar y la mermelada



Nuevo revestimiento bicapa
a base de **PFA, la excelencia
de la antiadherencia**,
para proporcionar un desmoldado fácil
y rápido, sin materia grasa

★★★★
EXCELENTE
Antiadherente / Non-stick effect

DOBLE CAPA | **REFUERZO CERÁMICO**
DOUBLE COATING | REINFORCED CERAMIC
BASE PFA |

Los moldes Obsidian, ideales para usar en pastelería, se adaptan perfectamente a las recetas saladas. La gama Obsidian se compone de 26 referencias diferentes entre las que figuran 3 tamaños de moldes de borde alto que van del formato familiar al formato individual.

MOLDE CAKE ESTAMPADO

Material un 20% más grueso para mayor resistencia y durabilidad. Un 20% más de antiadherente para un perfecto control de la caramelización.

Acero revestido antiadherente Obsidian

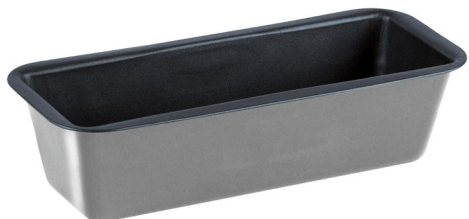

GOBEL

Réf.	↔	↗	⊥	📦	🔍	> <
423320	26/23	9,5/6,5	7,5	0,32	Embutido - Bordeado	6/10

TORTIERA REDONDA ACANALADA - FONDO FIJO

Material un 20% más grueso para mayor resistencia y durabilidad. Un 20% más de antiadherente para un perfecto control de la caramelización.

Acero revestido antiadherente Obsidian



GOBEL

Réf.	∅	⊥	📦	🔍	> <
426320	20	3	0,2	Fondo fijo	6/10
426330	24	3	0,3	Fondo fijo	6/10
426340	28	3	0,4	Fondo fijo	6/10
426350	32	3	0,5	Fondo fijo	6/10

PACK DE 6 TARTALETAS REDONDAS ACANALADAS

Material un 20% más grueso para mayor resistencia y durabilidad. Un 20% más de antiadherente para un perfecto control de la caramelización.

Acero revestido antiadherente Obsidian



GOBEL

Réf.	∅	⊥	📦	🔍	> <
470171	10/8,5	1,8	0,05	Fondo fijo	6/10

TORTIERA REDONDA ACANALADA - FONDO MÓVIL

Material un 20% más grueso para mayor resistencia y durabilidad. Un 20% más de antiadherente para un perfecto control de la caramelización.

Acero revestido antiadherente Obsidian



GOBEL

Réf.	∅	⊥	📦	🔍	> <
426440	28/27	3	0,42	Fondo móvil	6/10

TARTA ACANALADA CASERA PERFORADA - FONDO MÓVIL

Material un 20% más grueso para mayor resistencia y durabilidad. Un 20% más de antiadherente para un perfecto control de la caramelización.

Acero revestido antiadherente Obsidian

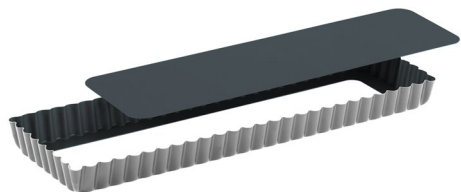

GOBEL

Réf.	↔	↗	⊥	📦	🔍	> <
425410	35/34	11/10	2,5	0,32	Rizada. Fondo móvil	6/10

TARTA CUADRADA RIZADA - FONDO MÓVIL

Material un 20% más grueso para mayor resistencia y durabilidad. Un 20% más de antiadherente para un perfecto control de la caramelización.

Acero revestido antiadherente Obsidian



GOBEL

Réf.	↔	↗	⊥	📦	🔍	> <
426810	23/22	23/22	2,5	0,47	rizada	6/10

MOLDE TARTA PERFORADO REDONDO ACANALADO - FONDO MÓVIL

Material un 20% más grueso para mayor resistencia y durabilidad. Un 20% más antiadherente para un perfecto control de la caramelización.

Acero revestido antiadherente Obsidian



GOBEL

Réf.	∅	I	Peso		> <
426431	24	2,5	0,31		6/10
426441	28	2,8	0,41		6/10
426451	32	2,8	0,52		6/10

MOLDE «MANQUÉ» REDONDO LISO

Material un 20% más grueso para mayor resistencia y durabilidad. Un 20% más de antiadherente para un perfecto control de la caramelización.

Acero revestido antiadherente Obsidian



GOBEL

Réf.	∅	I	Peso		> <
423730	20/17,5	5	0,27		6/10
423750	24/10	5	0,37		6/10
423760	26/23,5	5	0,43		6/10

SAVARÍN

Material un 20% más grueso para mayor resistencia y durabilidad. Un 20% más de antiadherente para un perfecto control de la caramelización.

Acero revestido antiadherente Obsidian



GOBEL

Réf.	∅	I	Peso		> <
454050	24	5	0,43	Abierto - embutido	6/10

CAJA DE 6 MOLDES PARA MUFFIN

Material un 20% más grueso para mayor resistencia y durabilidad. Un 20% más de antiadherente para un perfecto control de la caramelización.

Acero revestido antiadherente Obsidian



GOBEL

Réf.	∅	I	Peso		> <
496512	7	3,5	0,02		6/10

MOLDE DE BRIOCHE

Material un 20% más grueso para mayor resistencia y durabilidad. Un 20% más de antiadherente para un perfecto control de la caramelización.

Acero revestido antiadherente Obsidian



GOBEL

Réf.	∅	I	Peso		> <
423040	20,5	9	0,29		6/10

PACK DE 6 MOLDES DE BRIOCHES PEQUEÑAS

Material un 20% más grueso para mayor resistencia y durabilidad. Un 20% más de antiadherente para un perfecto control de la caramelización.

Acero revestido antiadherente Obsidian



GOBEL

Réf.	∅	I	Peso		> <
493740	8/4	3,2	0,05	Fondo liso	6/10

MOLDE «CHARLOTTE» OBSIDIAN





Material un 20% más grueso para mayor resistencia y durabilidad. Un 20% más de antiadherente para un perfecto control de la caramelización.

 Acero revestido antiadherente Obsidian



GOBEL



Ref.					> <
412620	18,15	10	0,36	Embutido	6/10



HOJALATA

BANDEJAS DE COCCIÓN/PAN/PIZZA	223
MOLDES PLEGABLES PARA PATE	226
MOLDES CAKE	227
BRIOCHE	228
MOLDES PARA TARTAS Y PASTELES	231
MOLDES MANQUE Y MILLASSON	235
MOLDE PARA GENOISE Y MÓDULOS TEMÁTICOS	237
MONOPORCIONES Y PASTELES	239

ORIGINE

MOLDES BIODEGRADABLES «ORIGINE»	243
--	------------

FRANCE 1887
GOBEL®
 rien ne remplace le fait main

LA HOJALATA

«LA AUTENTICIDAD»

EL MATERIAL + SANO

- La hojalata es un material **natural**, duradero y 100 % reciclable.

EXCELENTE CONDUCTOR DEL CALOR

- Cocción **perfecta** y homogénea
- Aumento del calor **rápido**

CARAMELIZACIÓN IDEAL

- ¡**Crujiente** por fuera y esponjoso por dentro!
- El contacto del molde **favorece** la caramelización del azúcar



EL CONSEJO DEL CHEF

Para lograr un desmoldado impecable, engrasar bien el molde con mantequilla, harina o un spray de desmoldado.

MANTENIMIENTO

- Secar bien después de lavar
- No lavar en el lavavajillas
- Evitar las esponjas abrasivas

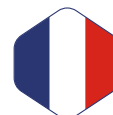

Made in France







BANDEJA PARA 6 MAGDALENAS XXL

Para magdalenas XXL. Borde redondo. Cavidad : 106 x 66 mm.

 Hojalata



GOBEL

Réf.					
164810	39,6	22,7	2	0,4	5/10





BANDEJA DE 12 MAGDALENAS

Huella prof. 8 mm - bordes redondos

 Hojalata



GOBEL

Réf.					
164710	39,5	20	1,7	0,4	5/10

BANDEJA DE 20 MINI MAGDALENAS

Cavidad prof. 42 mm. Borde redondo.

 Hojalata



GOBEL

Réf.					
164510	39,5	12,5	1,3	0,23	5/10





BANDEJA PARA 6 FINANCIEROS

Embutida. 6 cavidades : 98 x 48 mm.

 Hojalata



GOBEL

Réf.					
120710	38	18	1,3	0,31	5/10

BANDEJA PARA 12 MINI FINANCIEROS O «PASTELES ROSES DE REIMS»

Embutida. 2 lneas de 6 moldes de 7,5 mm

 Hojalata



GOBEL

Réf.					
167030	29	19,8	1,7	0,31	5/10





PLACA PLISADA «DIENTES DE LOBO»

Cuenta 20 galletas por bandeja.

 Hojalata



GOBEL

Réf.					
120510	30	29	2,5	0,62	5/10

LA BANDEJA PARA MAGDALENAS

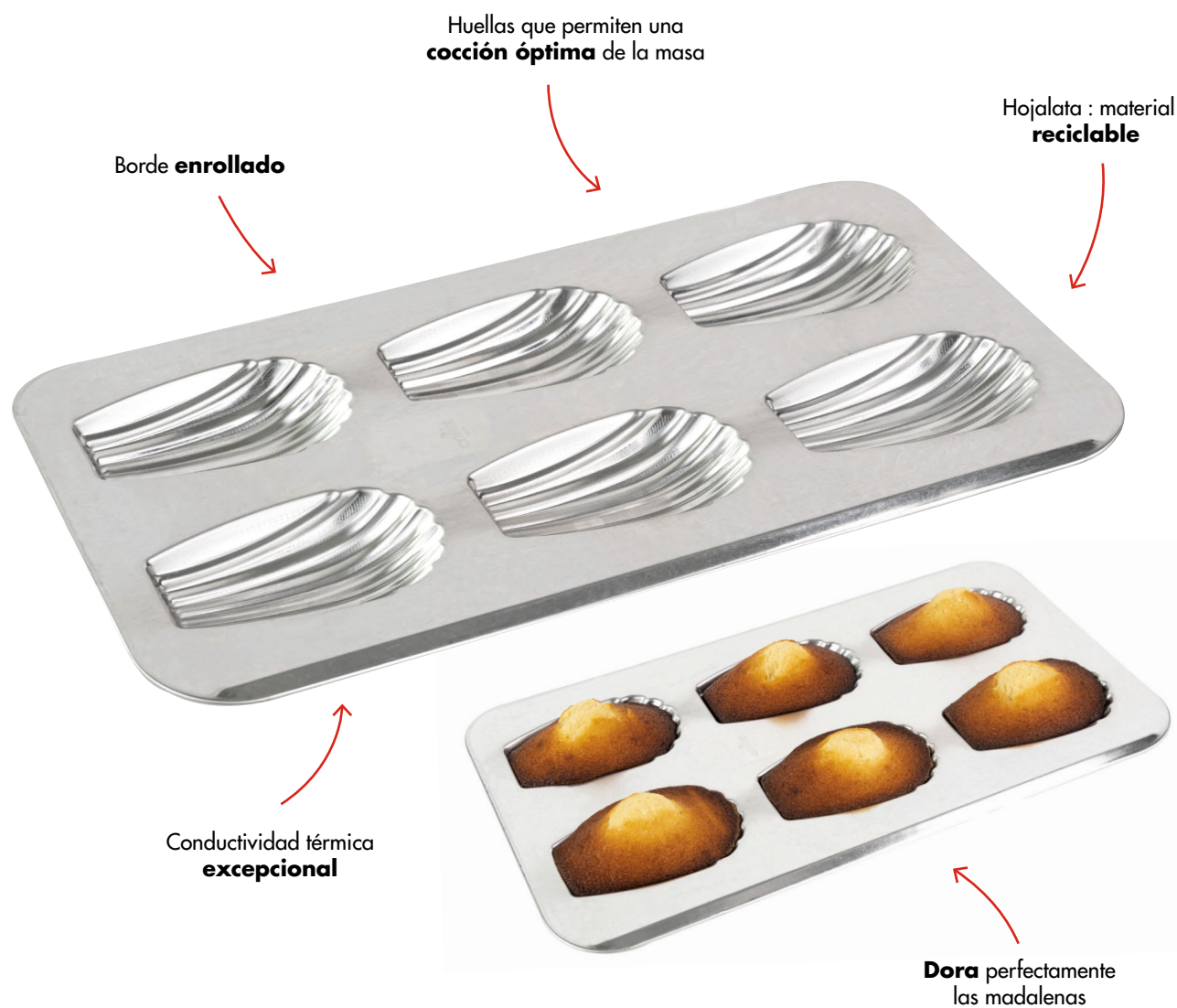

Huellas que permiten una **cocción óptima** de la masa

Hojalata : material **reciclable**

Borde **enrollado**

Conductividad térmica **excepcional**

Dora perfectamente las magdalenas

Desde 1887, GOBEL pone a su servicio toda su experiencia y su saber hacer histórico en la fabricación de moldes de hojalata. Actualmente, es uno de los últimos talleres para moldes en Francia que realiza el embutido de sus moldes en este material ecológico que ofrece una conductividad térmica excepcional. Garantía de un resultado gustativo sin igual, estos moldes son famosos por conferir crujiente a las masas : doradas por fuera y tiernas por dentro, sublimarán sus creaciones pas teleras.

MOLDE BRAZO GITANO

Embutido - bordeado en alambre

 Hojalata



GOBEL

Réf.	↔	↗	⊥	📦	🔍	> <
121020	40	30	1,6	0,61	Plazos de entrega : 5 semanas	5/10
121010	37	27	1,6	0,53	Plazos de entrega : 5 semanas	5/10

MOLDE PARA PAN RECTANGULAR

Las perforaciones promueven la circulación de aire caliente y permiten que escape el exceso de humedad para una cocción uniforme.

 Hojalata



GOBEL

Réf.	↔	↗	⊥	📦	> <
134010	24/22	12/10	7	0,34	5/10

BANDEJA PARA PIZZA

En hojalata, mejor conductor de calor que el acero inoxidable.

 Hojalata



GOBEL

Réf.	∅	⊥	📦	> <
127010	24/23	1,3	0,24	5/10
127020	30/29	1,3	0,35	5/10
127030	34/33	1,3	0,42	5/10

MOLDE PARA PAN PERFORADO

Las perforaciones promueven la circulación de aire caliente y permiten que escape el exceso de humedad para una cocción uniforme.

 Hojalata



GOBEL



Réf.	↔	↗	⊥	📦	> <
123690	27/25	10,5/8	8	0,35	5/10
134000	16/14	10/8	7	0,22	5/10

MOLDE DE PAN REDONDO

Las perforaciones promueven la circulación de aire caliente y permiten que escape el exceso de humedad para una cocción uniforme.

 Hojalata



GOBEL

Réf.	∅	⊥	📦	> <
135010	23/20	6	0,31	5/10

BANDEJA PARA PIZZA PERFORADA CON PIES

En hojalata, garantía de caramelización y frescura.

 Hojalata



GOBEL

Réf.	∅	⊥	📦	> <
127120	30/29	1,5	0,34	5/10
127130	34/33	1,5	0,42	5/10

MOLDE LARGO PARA PATÉ (MINI)

Desmoldeo fácil y práctico gracias a la bisagra y al fondo extraíble.

Hojalata

GOBEL

Réf.	↔	↗	⊥	📦	> <
119410	30	4	6	0,37	5/10
119440	50	4	6	0,58	5/10

MOLDE LARGO PARA PATÉ

Desmoldeo fácil y práctico gracias a la bisagra y al fondo extraíble.

Hojalata

GOBEL

Réf.	↔	↗	⊥	📦	> <
119710	30	8	8	0,53	5/10
119720	35	8	8	0,6	5/10
119730	40	8	8	0,67	5/10
119740	50	8	8	0,8	5/10

MOLDE PARA PATÉ O CAKE PLEGABLE

Desmoldeo fácil y práctico.

Hojalata

GOBEL

Réf.	↔	↗	⊥	📦	> <
120010	24/22	9,5/8	7	0,35	5/10
120020	27/25	10/9	7,5	0,42	5/10
120030	30/28,5	10/9	7,5	0,46	5/10

MOLDE CAKE ESTAMPADO

 Hojalata







GOBEL







MOLDE CAKE CURVADO BORDEADO CON ALAMBRE

 Hojalata



GOBEL

Ref.					
123330	28/25	10/7,5	7,5	0,35	5/10
123320	26/23	9,5/6,5	7,5	0,28	5/10

Ref.					
123610	15/13	7/5	5,5	0,16	5/10
123620	18/15,7	8/5,7	6,5	0,2	5/10
123630	 21/18,5	9/6,5	7	0,26	5/10
123640	24/21,5	9/6,5	7	0,3	5/10
123650	 27/24,2	10,5/7,7	8	0,36	5/10
123660	30/27,2	10,5/7,7	8	0,4	5/10
123670	33/30,2	10,5/7,7	8	0,43	5/10
123680	36/33,2	10,5/7,7	8	0,46	5/10

BRIOCHE - 9 COSTADOS

Fondo liso.

Hojalata

GOBEL

Réf.	∅	⊥	📦	> <
193710	6/2,8	2,5	0,02	5/10
193720	7/3,7	2,8	0,03	5/10

BRIOCHE - 10 COSTADOS

Fondo liso.

Hojalata

GOBEL

Réf.	∅	⊥	📦	> <
193730	7,5/4	3	0,03	5/10
193740	8/4	3,5	0,04	5/10
193750	9/4,5	3,5	0,04	5/10
193760	10/5,5	4	0,05	5/10
193770	11/5,5	3,5	0,06	5/10

BRIOCHE GRANDE - GRANDES COSTADOS

Fondo liso.

Hojalata

GOBEL

Réf.	∅	⊥	📦	> <
123010	14/7,3	6	0,12	5/10
123020	16/8,3	5,5	0,15	5/10
123030	18/19,1	5,6	0,18	5/10
123040	20/9,7	7,2	0,24	5/10
123050	22/9,9	9	0,3	5/10



TORTERA ESTRIADA PERFORADA



Fondo móvil : desmoldado fácil
100 % de éxito

Hojalata : material **reciclable**



Conductividad térmica **excepcional**

Fondo perforado : **distribución homogénea** del calor, perfecto para preparaciones espesas

Desde 1887, GOBEL pone a su servicio toda su experiencia y su buen hacer histórico en la fabricación de moldes de hojalata. Hoy en día, GOBEL es uno de los últimos talleres de moldeo en Francia que estampa sus moldes en este material ecológico que ofrece una conductividad térmica excepcional.

TORTIERA REDONDA ACANALADA

Hojalata



GOBEL

Réf.	∅	I		> <
126320	20/18,5	2,8	0,17	5/10
126322	22/20	2,5	0,22	5/10
126330	24/23	2,8	0,25	5/10
126332	26/24	2,8	0,29	5/10
126340	28/27	2,5	0,32	5/10
126342	30/28	2,5	0,37	5/10
126350	32/31	2,5	0,42	5/10

TORTIERA REDONDA ACANALADA - FONDO MÓVIL

Desmoldeo fácil y práctico gracias al fondo móvil.

Hojalata



GOBEL

Réf.	∅	I		> <
126420	20/18,5	2,8	0,19	5/10
126422	22/20	2,5	0,22	5/10
126430	24/23	3	0,26	5/10
126432	26/24	2,5	0,3	5/10
126440	28/27	2,5	0,35	5/10
126442	30/28	2,5	0,38	5/10
126450	32/31	2,8	0,43	5/10

TORTIERA REDONDA ACANALADA ALTA

Hojalata



GOBEL

Réf.	∅	I		> <
126520	20/18,5	3,5	0,2	5/10
126522	22/20	3,5	0,24	5/10
126530	24/22,5	3,5	0,27	5/10
126532	26/24	3,5	0,31	5/10
126540	28/26,5	3,5	0,34	5/10
126542	30/28	3,5	0,4	5/10
126550	32/30,5	3,5	0,42	5/10

TORTIERA REDONDA ACANALADA

Las perforaciones promueven la circulación de aire caliente y permiten que escape el exceso de humedad para una cocción uniforme.

Hojalata



GOBEL

Réf.	∅	I		> <
126321	20	2,5	0,17	5/10
126325	22	2,5	0,22	5/10
126331	24	2,5	0,25	5/10
126335	26	2,5	0,3	5/10
126341	28	2,5	0,31	5/10
126345	30	2,5	0,35	5/10
126351	32	2,5	0,39	5/10

TORTIERA REDONDA ACANALADA ALTA - FONDO MÓVIL

Desmoldeo fácil y práctico gracias al fondo móvil.

Hojalata

GOBEL

Réf.	∅	I	📦	> <
126620	20/18,5	3,5	0,22	5/10
126622	22/20	3,5	0,26	5/10
126630	24/22,5	3,5	0,29	5/10
126632	26/24	3,5	0,33	5/10
126640	28/26,5	3,5	0,37	5/10
126642	30/28	3,5	0,43	5/10
126650	32/30,5	3,5	0,4	5/10

TORTIERA ACANALADA PERFORADA - FONDO MÓVIL

Cómodo desmoldeo gracias al fondo móvil. Las perforaciones promueven la circulación de aire caliente y permiten que escape el exceso de humedad para una cocción uniforme.

Hojalata

GOBEL

Réf.	∅	I	📦	> <
126421	20	2,5	0,18	5/10
126425	22	2,5	0,22	5/10
126431	24	2,5	0,26	5/10
126435	26	2,8	0,29	5/10
126441	28	2,5	0,35	5/10
126445	30	2,5	0,38	5/10
126451	32	2,5	0,43	5/10

TARTAleta REDONDA ACANALADA

Hojalata

GOBEL

Réf.	∅	I	📦	> <
193520	5/4	1	0,01	5/10
193530	6/5	1	0,02	5/10
193540	7/6	1	0,02	5/10
193550	8/7	1	0,03	5/10
193560	9/7,5	1,5	0,04	5/10
193570	10/8,5	2	0,04	5/10
193572	11/9	2	0,05	5/10
193580	12/11	2	0,06	5/10
193590	14/13	3	0,09	5/10

TARTAleta REDONDA ACANALADA - FONDO MÓVIL

Desmoldeo fácil y práctico gracias al fondo móvil.

Hojalata

GOBEL

Réf.	∅	I	📦	> <
193470	10/8,5	2	0,05	5/10
193472	11/9	2	0,07	5/10
193480	12/11	2	0,08	5/10
193490	14/13	2,5	0,11	5/10

TARTELETA REDONDA LISA

Hojalata



GOBEL

Réf.	∅	h	kg	> <
193630	5/3	1,1	0,01	5/10
193640	6/3,8	1,5	0,02	5/10
193650	7/4,8	1,2	0,02	5/10
193660	8/5,8	1,5	0,02	5/10
193670	9/6,8	1,5	0,03	5/10
193680	10/7,8	1,5	0,04	5/10

ARO DE TARTA

Debido a que el estaño es un conductor mejor que el acero inoxidable, estos aros tartaleras proporcionan una pasta dorada y crujiente.

Hojalata



GOBEL

Réf.	∅	h	kg	> <
124940	10	2	0,03	4/10
124950	20	2	0,08	4/10
124990	28	2	0,12	4/10

TARTA RECTANGULAR ACANALADA

Hojalata



GOBEL

Réf.	l	l	h	kg	> <
125710	29/27,5	20,5/19,5	2,5	0,31	5/10

TARTA RECTANGULAR ACANALADA - FONDO MÓVIL

Desmoldeo fácil y práctico gracias al fondo móvil.

Hojalata

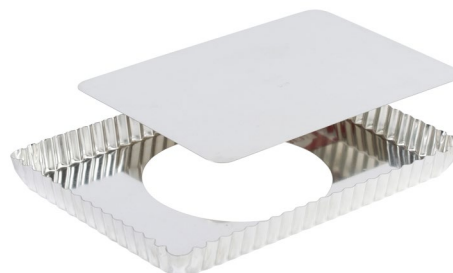

GOBEL

Réf.	l	l	h	kg	> <
125810	29/27,5	20,5/19,5	2,5	0,43	5/10

TARTA ACANALADA CASERA

Hojalata



GOBEL

Réf.	l	l	h	kg	> <
125310	35/34	11/10	2,5	0,23	5/10

TARTA ACANALADA CASERA - FONDO MÓVIL

Desmoldeo fácil y práctico gracias al fondo móvil.

Hojalata

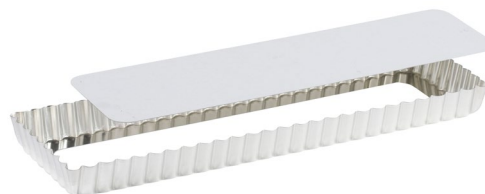

GOBEL

Réf.	l	l	h	kg	> <
125410	35/34	11/10	2,5	0,26	5/10

Las dimensiones se expresan en cm, el peso en kg.
www.louistellier.fr





TARTA ACANALADA CASERA PERFORADA - FONDO MÓVIL

Desmoldeo fácil y práctico gracias al fondo móvil.

 Hojalata



GOBEL

Réf.					
125412	35/34	11/10	2,5	0,26	5/10





TARTELETA RECTANGULAR ACANALADA - FONDO MÓVIL

Desmoldeo fácil y práctico gracias al fondo móvil.

 Hojalata



GOBEL





Réf.					
195330	12/11,2	7,5/6,6	2	0,1	5/10

TARTA CUADRADA RIZADA

 Hojalata



GOBEL

Réf.					
126710	23/22	23/22	2,5	0,28	5/10



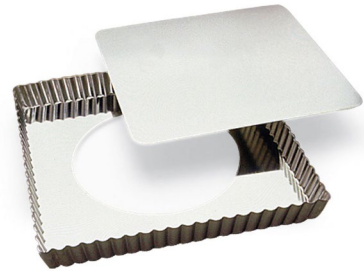

TARTA CUADRADA RIZADA - FONDO MÓVIL

Desmoldeo fácil y práctico gracias al fondo móvil.

 Hojalata



GOBEL

Réf.					
126810	23/22	23/22	2,5	0,37	5/10

TARTELETA CUADRADA RIZADA

 Hojalata



GOBEL

Réf.					
194370	10/9	10/9	2	0,06	5/10

TARTELETA CUADRADA RIZADA - FONDO MÓVIL

Desmoldeo fácil y práctico gracias al fondo móvil.

 Hojalata



GOBEL

Réf.					
194470	10/9	10/9	2	0,07	5/10

MOLDE «MANQUÉ» REDONDO LISO

Bordeado

 Hojalata



GOBEL

Réf.	∅	h	Peso	> <
123701	10/9	3	0,07	5/10
123702	12/10,5	3,5	0,09	5/10
123705	14/11,7	3,5	0,12	5/10
123710	16/13,6	4	0,15	5/10
123720	18/15,3	4,5	0,18	5/10
123730	20/17,5	4,5	0,23	5/10
123740	22/19,5	5	0,27	5/10
123750	24/21	5	0,29	5/10
123760	26/23,5	5	0,34	5/10
123770	28/25	5	0,39	5/10
123780	30/27,5	5,5	0,46	5/10
123790	32/29,5	5,5	0,51	5/10

MOLDE REDONDO RIZADO - FONDO MÓVIL

Acanalado fino. Desmoldeo fácil y práctico gracias al fondo móvil.

 Hojalata



GOBEL

Réf.	∅	h	Peso	> <
124810	10/8	3	0,07	5/10
124820	15/13	4	0,19	5/10

MANQUÉ ROSETA

Bordeado

 Hojalata



GOBEL

Réf.	∅	h	Peso	> <
122130	20/17,5	5	0,23	5/10

«MANQUÉ» DESMONTABLE

2 fondos: 1 plano + 1 acanalado con cilindro para savarin. Fácil de desmoldar gracias a la bisagra.

 Hojalata



GOBEL

Réf.	∅	h	Peso	> <
121650	24	5,8	0,39	3/10
121660	26	5,8	0,44	3/10

«MANQUÉ» CUADRADO - FONDO FIJO

Borde reforzado con alambre

Hojalata

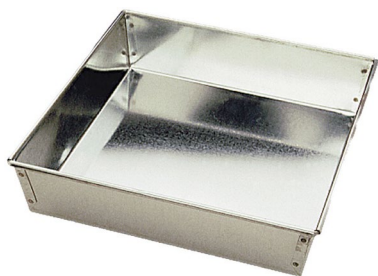
GOBEL

Réf.					
124110	22/20,5	22/20,5	5	0,43	5/10
124120	24/22,5	24/22,5	5	0,48	5/10

«MANQUÉ» CUADRADO - FONDO MÓVIL

Borde reforzado con alambre. Cómodo desmoldeo gracias al fondo móvil.

Hojalata

GOBEL

Réf.					
124210	22/20,5	22/20,5	5	0,52	5/10
124220	24/22,5	24/22,5	5	0,6	5/10

MOLDE PARA «GÉNOISE»

Bordeado en alambre. En lata, garantía de caramelización y crocante por fuera.

Hojalata



GOBEL

Réf.	↔	↗	⊥	📦	> <
125100	30/30,8	20/20,8	3,5	0,46	5/10
125105	35/35,8	25/25,8	3,5	0,6	5/10
125110	40/41,4	30/31,4	3,5	1,03	5/10

SAVARÍN

Cilindro abierto. Embutido. Savarin, forma de corona. Ideal para ron baba y king cake.

Hojalata



GOBEL

Réf.	∅	⊥	📦	> <
124040	22	4,5	0,26	5/10
124050	24	5	0,3	5/10

SAVARÍN PROFUNDO

Abierto. Embutido. En hojalata, garantía de caramelización y frescura.

Hojalata



GOBEL

Réf.	∅	⊥	📦	> <
154050	24	5,8	0,35	5/10
154060	26	6	0,41	5/10

SAVARÍN ACANALADO «TROI FRÈRES»

Cilindro abierto. Embutido. Savarin, forma de corona. Ideal para ron baba y king cake.

Hojalata



GOBEL

Réf.	∅	⊥	📦	> <
124340	22	5,5	0,36	5/10

SAVARÍN INDIVIDUAL CERRADO

Cilindro bloqueado. Savarin, forma de corona. Ideal para ron baba y king cake.

Hojalata



GOBEL

Réf.	∅	⊥	📦	> <
123930	8	2	0,04	5/10

SAVARÍN INDIVIDUAL ABIERTO

Cilindro abierto. Savarin, forma de corona. Ideal para ron baba y king cake.

Hojalata



GOBEL

Réf.	∅	⊥	📦	> <
124030	8	2	0,04	5/10
124034	12	2,5	0,09	5/10

Las dimensiones se expresan en cm, el peso en kg.
www.louistellier.fr

MOLDE «CHARLOTTE»

Embutida.

 Hojalata



GOBEL

Ref.	Ø	I	Peso	> <
112620	18/15	10	0,3	5/10

PUDÍN DIPLOMÁTICO

Para galletas y jaleas - embutido

 Hojalata



GOBEL

Ref.	Ø	I	Peso	> <
124610	18/15	9	0,26	5/10

MOLDE BIZCOCHO DE QUESO

En hojalata, garantía de caramelización y frescura.

 Hojalata



GOBEL

Ref.	Ø	I	Peso	> <
151210	14/7	4	0,11	5/10

PACK DE 30 «PETITS-FOURS»

6 ud/forma x 5 formas: redondo rizado + cuadrado rizado + barquillo Calisson + redondo liso + rumbo liso

Hojalata



GOBEL

Réf.	∅	h	l	Peso	> <
185400	12	3	0,24		5/10

«PETITS-FOURS»

Hojalata



GOBEL



Réf.	h	l	∅	h	Peso	Forma	> <
191010	6				0,01	Rumbo liso	5/10
191510	6				0,01	Barquillo «calisson»	5/10
192010	5				0,01	Rectángulo liso	5/10
192510			3,5	1,5	0,01	Redondo alto	5/10
193510			4,5		0,01	Redondo rizado	5/10
193610		3,5/2,2	1		0,01	Tartaleta redonda lisa	5/10
193620		4/2,6	1		0,01	Tartaleta redonda lisa	5/10
194020	7	2,8	1		0,01	Tartaleta mini barquita lisa	5/10
195010			3,5	1	0,01	Cuadrado rizado	5/10
195510			4,5		0,01	Cúpula redonda rizada	5/10
196010			4,5		0,01	Ovalado rizado	5/10
196510			4,5		0,01	Cúpula ovalada rizada	5/10

BARQUITA LISA

Hojalata



GOBEL



Réf.	h	l	∅	Peso	> <
194030	8	3,3	1,2	0,01	5/10
194040	9	4	1,2	0,01	5/10
194050	10	4,3	1,3	0,02	5/10
194060	11	4,6	1,3	0,02	5/10
194070	12	5	1,3	0,02	5/10

BARQUITA ACANALADA

Hojalata



GOBEL



Réf.	h	l	∅	Peso	> <
194110	8	4	1,2	0,02	5/10
194120	9	4,3	1,2	0,02	5/10
194130	10	4,5	1,2	0,02	5/10
194140	11	4,7	1,3	0,02	5/10
194150	12	5	1,4	0,01	5/10

MOLDE ASPIC OVALADO CON FONDO LISO

Perfecto para preparar huevos en gelatina, terrinas o mousses. Estampado, bordeado.

Hojalata



GOBEL



Réf.	h	l	∅	Peso	> <
130210	7,5	5,5	3,8	0,04	5/10

MOLDE ASPIC OVALADO CON FONDO ESTRELLA

Perfecta para preparar huevos en gelatina, terrinas o mousses. Estampado. Bordeado.

Hojalata



GOBEL



Réf.	h	l	∅	Peso	> <
130310	7,5	5,5	3,8	0,04	5/10

FLANERO REDONDO «DARIOLE»

Emboutido. Bordeado en alambre. En lata, garantía de caramelización y crocante por fuera.

Hojalata



GOBEL

Réf.	∅	h	Peso		> <
129810	6/4,8	6	0,05		5/10

MOLDE PARA MUFFIN

Hojalata



GOBEL

Réf.	h	∅	h	Peso		> <
196511	7	7	3,5	0,02		5/10

PASTÉIS DE NATA

Hojalata



GOBEL

Réf.	∅	h	Peso		> <
196515	7,5	2	0,03	Una unidad	5/10
196517	7,5	7,8	0,62	Lote de 24	5/10

CAJA DE 6 PASTÉIS DE NATA

Hojalata



GOBEL

Réf.	∅	h	Peso		> <
196516	7,5	2,5	0,17		5/10





EL MOLDE DE PAPEL PROFESIONAL

«LA PRACTICIDAD»

MATERIAL 100 % BIODEGRADABLE

- Molde de **papel natural**
- Compostable en casa*

DESMOLDADO FÁCIL Y RÁPIDO

- Sin **materia grasa**, desmoldado perfecto
- **Calidad profesional**
- El molde natural que se utiliza en panadería por fin **accesible** para el público en general

EXCELENTE CONDUCTOR DEL CALOR

- Cocción perfecta y homogénea
- Aumento del calor rápido, hasta 220°C

* Molde de tarta y tartaleta



EL CONSEJO DEL CHEF

Ideal para sus eventos (meriendas, cumpleaños...) para preparar recetas dulces y saladas.

USO

- Uso único
- Cocción en el horno y el microondas
- Frigorífico y congelador
- Evitar la humedad



PACK 15 MOLDES AGRIOS PROFESIONALES - ORIGINE

100% natural y biodegradable. El primer molde para hornear desechable profesional accesible de retail. ideal para eventos, picnics ...

Papel



GOBEL

Ref.				
GL19P004	24,6	2,3	0,01	Biodegradable - Compostable

PACK DE 15 MOLDES CAKE PROFESIONALES - ORIGINE

100% natural y biodegradable. El primer molde para hornear desechable profesional accesible de retail. ideal para eventos, picnics ...

Papel



GOBEL

Ref.			
GL19P005	23,3	7,3	Biodegradable

PACK DE 25 MOLDES PROFESIONAL CAKE MEDIANO - ORIGINE

100% natural y biodegradable. El primer molde para hornear desechable profesional accesible de retail. ideal para eventos, picnics ...

Papel



GOBEL

Ref.			
GL19P006	19	5,5	Biodegradable

PACK DE 50 MOLDES PROFESIONAL MUFFINS - ORIGINE

100% natural y biodegradable. El primer molde para hornear desechable profesional accesible de retail. ideal para eventos, picnics ...

Papel



GOBEL

Ref.			
GL19P001	7,2	4	Biodegradable



COBEL
Made in France

100

ACERO INOXIDABLE

ARO DE TARTA CON BORDES	246
ARO DE TARTA SIN BORDES	249
FORMAS DE ACERO INOXIDABLE	252
MARCO A OPERA Y GENOISE	261
MOLDE TRONCO DE NAVIDAD	263

ARO DE TARTA BORDE REDONDO

Acero inoxidable

GOBEL

Ref.	∅	h	Peso	> <
824910	7	2	0,02	4/10
824920	8	2	0,03	4/10
824930	9	2	0,03	4/10
824940	10	2	0,03	4/10
824945	11	2	0,04	4/10
824941	12	2	0,04	4/10
824942	14	2	0,05	4/10
824943	16	2	0,05	4/10
824944	18	2	0,06	4/10
824950	20	2	0,06	4/10
824960	22	2	0,07	4/10
824970	24	2	0,08	4/10
824980	26	2	0,08	4/10
824990	28	2	0,09	4/10
824992	30	2	0,1	4/10
824994	32	2	0,11	4/10

ARO DE TARTA - ALTO BORDE REDONDO

Acero inoxidable

GOBEL

Ref.	∅	h	Peso	> <
834910	7	2,7	0,03	4/10
834920	8	2,7	0,03	4/10
834930	9	2,7	0,04	4/10
834940	10	2,7	0,04	4/10
834941	12	2,7	0,05	4/10
834942	14	2,7	0,06	4/10
834943	16	2,7	0,07	4/10
834944	18	2,7	0,08	4/10
834950	20	2,7	0,08	4/10
834960	22	2,7	0,09	4/10
834970	24	2,7	0,1	4/10
834980	26	2,7	0,1	4/10
834990	28	2,7	0,11	4/10
834992	30	2,7	0,12	4/10
834994	32	2,7	0,13	4/10

CAJA DE 4 AROS DE TARTA

Acero inoxidable

GOBEL

Ref.	∅	h	Peso	> <
889830	9	2	0,14	4/10

CAJA DE 6 AROS GALLETA

Acero inoxidable

GOBEL

Ref.	∅	h	Peso	> <
834995	5,5	1,2	0,1	4/10

ARO DE TARTA BORDE REDONDO - CUADRADO

Para cocinar o emplatar.

Acero inoxidable



GOBEL

Réf.						
835530	18	18	2,7	0,17	4/10	
835540	20	20	2,7	0,19	4/10	
835550	22	22	2,7	0,21	4/10	
835560	24	24	2,7	0,23	4/10	
865530	18	18	2	0,16	4/10	
865540		20	20	2	0,18	4/10
865550	22	22	2	0,19	4/10	
865560	24	24	2	0,21	4/10	

ARO DE TARTA BORDE REDONDO - RECTANGULAR

Para cocinar o emplatar.

Acero inoxidable



GOBEL

Réf.						
865310		35	11	2	0,2	4/10
865320	55	11	2	0,29	4/10	

ARO REDONDO AJUSTABLE

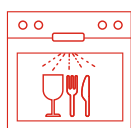

Todos los diámetros **posibles**
entre **16 y 28 cm**

Graduado en el
interior cada **2 cm**



**Acero
inoxidable**

Se bloquea en el **tamaño
deseado** con el pasador
de fijación

Ideal para preparar las recetas de pastelería cruda vegetariana y los pasteles de pisos, es la herramienta del pastelero profesional para preparar pasteles, bizcochos genoveses, mousses, postres y pasteles de merengue con nata.

Perfecto para una presentación cuidada de las recetas saladas : tians, parmentier, etc.

Modo de empleo :

- Apretar las asas para reducir el tamaño del círculo y aflojarlas para ampliarlo,
- Mover el pasador hacia la izquierda para bloquear el círculo y hacia la derecha para desbloquearlo,
- Se utiliza sobre una placa pastelera cubierta con papel de cocción.

ARO REDONDO AJUSTABLE

Ajustable de 160 à 280 mm.

Acero inoxidable



GOBEL

Réf.	∅	I	📦	> <
896480	16/28	6	0,27	6/10

ARO INOX A50

Para cocinar o emplatar.

Acero inoxidable



GOBEL

Réf.	∅	I	📦	> <
866420	5	5	0,04	6/10
866440	6	5	0,05	6/10
866460	7	5	0,05	6/10
866480	8	5	0,06	6/10

ARO MOUSSE A40

Acero inoxidable



GOBEL

Réf.	∅	I	📦	> <
865001	5	4	0,03	6/10
865003	6	4	0,04	6/10
865004	6,5	4	0,04	6/10
866260	7	4	0,04	6/10
865000	7,5	4	0,04	6/10
866280	8	4	0,05	6/10

ARO PARA POSTRE A35

Para cocinar o emplatar.

Acero inoxidable



GOBEL

Réf.	∅	I	📦	> <
865102	8	3,5	0,07	6/10
865104	10	3,5	0,07	10/10
865105	11	3,5	0,1	10/10
865110	14	3,5	0,11	10/10
865120	16	3,5	0,14	10/10
865130	18	3,5	0,16	10/10
865140	20	3,5	0,17	10/10
865150	22	3,5	0,19	10/10
865160	24	3,5	0,21	10/10
865170	26	3,5	0,22	10/10
865180	28	3,5	0,24	10/10
865190	30	3,5	0,26	10/10

CAJA DE 4 AROS CON EMPUJADOR

Circulo: ∅ 70 x 40 mm. Empujador : ∅ 68 mm

Acero inoxidable



GOBEL

Réf.	I	📦	> <
813850	4	0,27	6/10

ARO MOUSSE A45

Acero inoxidable

GOBEL

Réf.	∅	I	⊞	> <
866320	5	4,5	0,03	6/10
866330	5,5	4,5	0,04	6/10
866340	6	4,5	0,04	6/10
866350	6,5	4,5	0,04	6/10
866360	7	4,5	0,05	6/10
866370	7,5	4,5	0,05	6/10
865010	8	4,5	0,05	6/10
865011	9	4,5	0,06	6/10
865012	10	4,5	0,09	8/10
865020	12	4,5	0,11	8/10
865030	14	4,5	0,12	10/10
865040	16	4,5	0,18	10/10
865050	18	4,5	0,2	10/10
865060	20	4,5	0,22	10/10
865070	22	4,5	0,24	10/10
865080	24	4,5	0,27	10/10
865090	26	4,5	0,29	10/10
865092	28	4,5	0,3	10/10
896450	36	4,5	0,76	10/10

ARO MOUSSE TRIO

Convexo - separación extraíble

Acero inoxidable

GOBEL

Réf.	∅	I	⊞	> <
890850	18	4,5	0,35	10/10

ARO MOUSSE DUO

Convexo. Separación extraíble.

Acero inoxidable

GOBEL

Réf.	∅	I	⊞	> <
890650	18	4,5	0,31	10/10

CONJUNTO DE 6 AROS MOUSSE

Acero inoxidable

GOBEL

Réf.	∅	I	⊞	> <	
877821	45	7,5	4	0,41	6/10

ARO REDONDO VACHERIN

Acero inoxidable



GOBEL

Ref.				
865680	8	6	0,07	10/10
865690	9	6	0,08	10/10
864904	10	6	0,09	10/10
864905	12	6	0,18	10/10
864910	14	6	0,17	10/10
864920	16	6	0,24	10/10
864930	18	6	0,26	10/10
864940	20	6	0,3	10/10
864950	22	6	0,33	10/10
864960	24	6	0,35	10/10
864970	26	6	0,38	10/10
864980	28	6	0,41	10/10
864990	30	6	0,44	10/10
898250	36	6	1,04	20/10
898270	40	6	1,15	20/10

ARO REDONDO

Para cocinar o emplatar.

Acero inoxidable

GOBEL

Réf.	∅	I	⏏	> <
866004	4	3	0,02	6/10
866005	5	3	0,02	6/10
866010	5,5	3	0,03	6/10
866020	6	3	0,03	6/10
866030	6,5	3	0,03	6/10
866040	7	3	0,03	6/10
866050	7,5	3	0,03	6/10
866060	8	3	0,04	6/10

EMPUJADOR REDONDO

Acero inoxidable

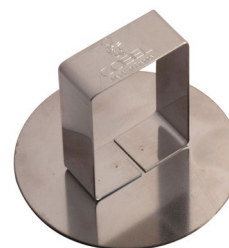
GOBEL

Réf.	∅	I	⏏	> <
866600	4,8	4,7	0,03	10/10
866610	5,8	4,7	0,03	10/10
866630	6,8	4,7	0,04	10/10
866632	7,8	4,7	0,05	10/10
866640	7,3	4,7	0,04	10/10
866650	8,8	4,7	0,06	10/10
866660	9,8	4,7	0,07	10/10

CUADRADO

Para cocinar o emplatar.

Acero inoxidable

GOBEL

Réf.	↔	↗	I	⏏	> <
897000	8	8	2	0,05	20/10
869005	4	4	3	0,02	6/10
869010	5	5	3	0,03	6/10
869030	6	6	3	0,03	6/10
871220	3	3	3	0,02	6/10
867420	6	6	4	0,04	6/10
867430	7	7	4	0,05	6/10
864840	7	7	4,5	0,06	6/10
863310	8	8	4,5	0,09	8/10
863320	10	10	4,5	0,11	8/10
863322	12	12	4,5	0,13	10/10
863330	16	16	4,5	0,22	10/10
863340	18	18	4,5	0,25	10/10
863350	20	20	4,5	0,28	10/10
863360	22	22	4,5	0,3	10/10
863370	24	24	4,5	0,33	10/10

CAJA DE 4 RAROS CUADRADOS CON EMPUJADOR INOX.

Para cocinar o emplatar.

Cuadrados: L 70 mm. Empujador: 68 mm.

Acero inoxidable

GOBEL

Réf.	↔	↗	I	⏏	> <
887980	14	14	4	0,3	6/10

EMPUJADOR CUADRADO

Acero inoxidable



GOBEL

Réf.	↔	↗	⏊	📦	> <
866750	5,8	5,8	4,7	0,04	10/10
866755	6,8	6,8	4,7	0,04	10/10

CAJA DE 4 RECTANGULARES CON EMPUJADOR

Rectangulares: 90 x 30 x 35 mm . Empujador: 88 x 28 mm

Acero inoxidable

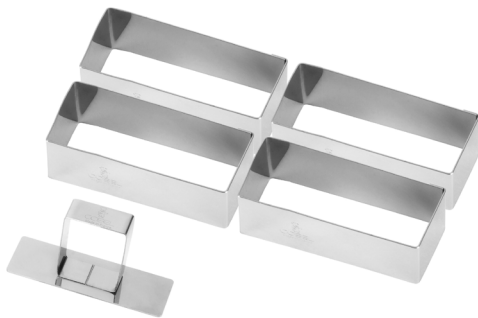

GOBEL

Réf.	📦	↔	↗	⏊	📦
881780	📦	12,5	13,5	3,5	0,25

RECTANGULAR

Para cocinar o emplatar.

Acero inoxidable



GOBEL

Réf.	↔	↗	⏊	📦	> <	
867505	5	3	3	0,02	6/10	
867530	6	3	3	0,02	6/10	
867510	6	5	3	0,03	6/10	
867740	8	4	3	0,05	6/10	
877630	📦	9	3,5	3	0,05	8/10ème
867540	10	3	3	0,05	8/10	
867560	12	3	3	0,06	8/10	
867760	12	4	3	0,05	8/10	
867360	12	4	3,5	0,09	10/10	
864330	📦	12	6	4,5	0,13	8/10
864350	16	8	4,5	0,16	10/10	
864370	20	10	4,5	0,21	10/10	
864390	24	12	4,5	0,24	10/10	
875910	8	5,5	5,5	0,09	8/10	

EMPUJADOR RECTANGULAR

Acero inoxidable

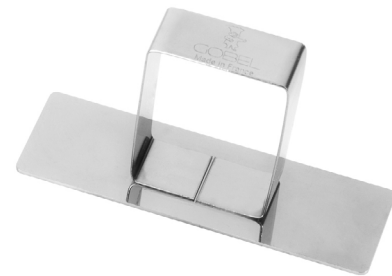

GOBEL

Réf.	↔	↗	⏊	📦
866740	8,8	2,8	4,7	0,03

CIFRAS

Para cocinar o preparar sus preparaciones en forma de números.

Acero inoxidable

GOBEL

Réf.					
884420	20	12	4,5	0,2	0 - Plazos de entrega : 3 a 4 semanas
884421	20	12	4,5	0,22	1 - Plazos de entrega : 3 a 4 semanas
884422	20	12	4,5	0,25	2 - Plazos de entrega : 3 a 4 semanas
884423	20	12	4,5	0,26	3 - Plazos de entrega : 3 a 4 semanas
884424	20	12	4,5	0,21	4 - Plazos de entrega : 3 a 4 semanas
884425	20	12	4,5	0,27	5 - Plazos de entrega : 3 a 4 semanas
884426	20	12	4,5	0,19	6 - Plazos de entrega : 3 a 4 semanas
884427	20	12	4,5	0,24	7 - Plazos de entrega : 3 a 4 semanas
884428	20	12	4,5	0,2	8 - Plazos de entrega : 3 a 4 semanas
884429	20	12	4,5	0,23	9 - Plazos de entrega : 3 a 4 semanas
884430	30	18	4,5	0,29	0 - Plazos de entrega : 3 a 4 semanas
884431	30	18	4,5	0,32	1 - Plazos de entrega : 3 a 4 semanas
884432	30	18	4,5	0,37	2 - Plazos de entrega : 3 a 4 semanas
884433	30	18	4,5	0,39	3 - Plazos de entrega : 3 a 4 semanas
884434	30	18	4,5	0,32	4 - Plazos de entrega : 3 a 4 semanas
884435	30	18	4,5	0,4	5 - Plazos de entrega : 3 a 4 semanas
884436	30	18	4,5	0,29	6 - Plazos de entrega : 3 a 4 semanas
884437	30	18	4,5	0,36	7 - Plazos de entrega : 3 a 4 semanas
884438	30	18	4,5	0,29	8 - Plazos de entrega : 3 a 4 semanas
884439	30	18	4,5	0,35	9 - Plazos de entrega : 3 a 4 semanas

LETRAS

Para cocinar o preparar sus preparaciones en forma de letras.

Acero inoxidable

GOBEL

Réf.					
884641	20	21,5	4,5	0,27	A - Plazos de entrega : 3 a 4 semanas
884642	20	18,5	4,5	0,26	B - Plazos de entrega : 3 a 4 semanas
884643	20	20	4,5	0,31	C - Plazos de entrega : 3 a 4 semanas
884644	20	19	4,5	0,24	D - Plazos de entrega : 3 a 4 semanas
884645	20	17,4	4,5	0,4	E - Plazos de entrega : 3 a 4 semanas
884646	20	15,5	4,5	0,3	F - Plazos de entrega : 3 a 4 semanas
884647	20	20	4,5	0,34	G - Plazos de entrega : 3 a 4 semanas
884648	20	19,5	4,5	0,38	H - Plazos de entrega : 3 a 4 semanas
884649	20	7	4,5		I - Plazos de entrega : 3 a 4 semanas
884650	20	16	4,5	0,26	J - Plazos de entrega : 3 a 4 semanas
884651	20	21,7	4,5	0,39	K - Plazos de entrega : 3 a 4 semanas
884652	20	16	4,5	0,24	L - Plazos de entrega : 3 a 4 semanas
884653	20	22,7	4,5	0,51	M - Plazos de entrega : 3 a 4 semanas
884654	20	19	4,5	0,38	N - Plazos de entrega : 3 a 4 semanas
884655	20	20	4,5	0,23	O - Plazos de entrega : 3 a 4 semanas
884656	20	17	4,5	0,24	P - Plazos de entrega : 3 a 4 semanas
884657	20	22	4,5	0,25	Q - Plazos de entrega : 3 a 4 semanas
884658	20	20	4,5	0,32	R - Plazos de entrega : 3 a 4 semanas
884659	20	16,5	4,5	0,35	S - Plazos de entrega : 3 a 4 semanas
884660	20	19,2	4,5	0,28	T - Plazos de entrega : 3 a 4 semanas
884661	20	21,7	4,5	0,36	U - Plazos de entrega : 3 a 4 semanas
884662	20	21	4,5	0,32	V - Plazos de entrega : 3 a 4 semanas
884663	20	27,8	4,5	0,47	W - Plazos de entrega : 3 a 4 semanas
884664	20	21	4,5	0,36	X - Plazos de entrega : 3 a 4 semanas
884665	20	22,4	4,5	0,29	Y - Plazos de entrega : 3 a 4 semanas
884666	20	19,5	4,5	0,37	Z - Plazos de entrega : 3 a 4 semanas

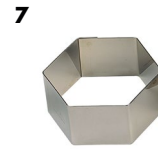
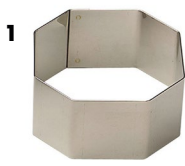

Réf.

1 CUADRADO CON FACETAS

Para cocinar o preparar sus preparaciones en forma cuadrada.

869330	6	6	3	0,03	Plazos de entrega : 3 a 4 semanas
863410	8	8	4,5	0,06	Plazos de entrega : 3 a 4 semanas

2 CUADRADO ABOMBADO

Para cocinar o preparar sus preparaciones en forma cuadrada.

869110	5	5	3	0,03	Plazos de entrega : 3 a 4 semanas
869130	6	6	3	0,03	Plazos de entrega : 3 a 4 semanas
863510	8	8	4,5	0,08	Plazos de entrega : 3 a 4 semanas
863540	18	18	4,5	0,22	Plazos de entrega : 3 a 4 semanas

3 CUADRADO CÓNCAVO

Para cocinar o preparar sus preparaciones en forma cuadrada.

869230	6	6	3	0,04	Plazos de entrega : 3 a 4 semanas
--------	---	---	---	------	-----------------------------------

4 DÚO CUADRADO

Para cocinar o alinear tus preparaciones en forma de cuadrado.

860430	12	12	4,5	0,19	Plazos de entrega : 3 a 4 semanas
--------	----	----	-----	------	-----------------------------------

5 SEMICÍRCULO

Para cocinar o emplatar.

868710	6	3	3	0,02	Plazos de entrega : 3 a 4 semanas
868730	8,5	4,5	3	0,03	Plazos de entrega : 3 a 4 semanas

6 GOTA - PÉTALO

Para cocinar o emplatar.

868110	9	6	3	0,03	Plazos de entrega : 3 a 4 semanas
863790	28	17,5	4,5	0,24	Plazos de entrega : 3 a 4 semanas

Réf.

7 HEXÁGONO

Para cocinar o emplatar.

866510	6	6	3	0,03	Plazos de entrega : 3 a 4 semanas
862760	22	22	4,5	0,27	Plazos de entrega : 3 a 4 semanas
862740	18	18	4,5	0,22	Plazos de entrega : 3 a 4 semanas
862750	20	20	4,5	0,24	Plazos de entrega : 3 a 4 semanas

8 LÁGRIMA

Para cocinar o emplatar.

868610	9	5	3	0,03	Plazos de entrega : 3 a 4 semanas
--------	---	---	---	------	-----------------------------------

9 DIAMANTE

Para cocinar o emplatar.

867010	9	6	3	0,03	Plazos de entrega : 3 a 4 semanas
--------	---	---	---	------	-----------------------------------

10 LUNA

Para cocinar o emplatar.

864180	26	16	4,5	0,29	Plazos de entrega : 3 a 4 semanas
--------	----	----	-----	------	-----------------------------------

11 MANO DE FÁTIMA

Para cocinar o emplatar.

884048	10	7	3	0,3	Plazos de entrega : 3 a 4 semanas
884049	7	5	3	0,21	Plazos de entrega : 3 a 4 semanas

12 OVALADO

Para cocinar o emplatar.

868010	7,5	4,5	3	0,03	Plazos de entrega : 3 a 4 semanas	868010
883948	10,5	6	4,5	0,05	Plazos de entrega : 3 a 4 semanas	883948

13

14

15

16

17

18

19

20

21

22

23

24

Réf.

13 OBLONGO

Para cocinar o emplatar.

884017	11	4	3	0,04	Plazos de entrega : 3 a 4 semanas
--------	----	---	---	------	-----------------------------------

14 TRIÁNGULO

Para cocinar o emplatar.

869530	7	6	3	0,03	Plazos de entrega : 3 a 4 semanas
863010	9	8	4,5	0,08	Plazos de entrega : 3 a 4 semanas
863020	11	10	4,5	0,1	Plazos de entrega : 3 a 4 semanas
863050	23	20	4,5	0,25	Plazos de entrega : 3 a 4 semanas
863070	27,5	24	4,5	0,29	Plazos de entrega : 3 a 4 semanas

15 TRIÁNGULO CON FACETAS

Para cocinar o emplatar.

863110	9	8	4,5	0,06	Plazos de entrega : 3 a 4 semanas
--------	---	---	-----	------	-----------------------------------

16 TRIÁNGULO ABOMBADO

Para cocinar o emplatar.

869610	6	6	3	0,03	Plazos de entrega : 3 a 4 semanas
869630	7	7	3	0,03	Plazos de entrega : 3 a 4 semanas
863260	19	19	4,5	0,21	Plazos de entrega : 3 a 4 semanas

17 TRIANGULAR CÓNCAVO

Para cocinar o emplatar.

869730	8	7,5	3	0,05	Plazos de entrega : 3 a 4 semanas
--------	---	-----	---	------	-----------------------------------

18 COMA

Para cocinar o emplatar.

868630	16	10	4,5	0,16	Plazos de entrega : 3 a 4 semanas
868640	20	13	4,5	0,19	Plazos de entrega : 3 a 4 semanas
868660	24	16	4,5	0,23	Plazos de entrega : 3 a 4 semanas
868680	28	19	4,5	0,28	Plazos de entrega : 3 a 4 semanas

Réf.

19 CAMISETA DE FÚTBOL

Para cocinar o emplatar.

883972	26,5	25,5	4,5	0,34	Bajo demanda
--------	------	------	-----	------	--------------

20 ESTRELLA

Para cocinar o emplatar.

884139	5	1,5	0,01	Plazos de entrega : 3 a 4 semanas	
896630	8	8	3	0,04	Plazos de entrega : 3 a 4 semanas
896635	10	9	4,5	0,07	Plazos de entrega : 3 a 4 semanas

21 CORAZÓN

Para cocinar o emplatar.

868510	6,5	6	3	0,07	Plazos de entrega : 3 a 4 semanas
883901	18	16	4,5	0,19	Plazos de entrega : 3 a 4 semanas
883902	23	20	4,5	0,24	Plazos de entrega : 3 a 4 semanas
883903	27,5	24	4,5	0,28	Plazos de entrega : 3 a 4 semanas

22 CORAZONES ENTRELAZADOS

Para cocinar o emplatar.

884023	14	8	3	0,07	Plazos de entrega : 3 a 4 semanas
--------	----	---	---	------	-----------------------------------

23 CORAZÓN ABOMBADO

Para cocinar o emplatar.

884032	8,5	8,5	3	0,04	Plazos de entrega : 3 a 4 semanas
--------	-----	-----	---	------	-----------------------------------

24 SÍMBOLO DE ARMIÑO (BRETAÑA)

Para cocinar o emplatar.

884018	10	7,5	3	0,05	Plazos de entrega : 3 a 4 semanas
--------	----	-----	---	------	-----------------------------------

25



26



27



28



29



30



31



32



33



34



35



36



Réf.

25 ZANAHORIA

Para cocinar o emplatar.

884035	12	4,5	3	0,05	Plazos de entrega : 3 a 4 semanas
884106	14	5,5	1,5	0,22	Plazos de entrega : 3 a 4 semanas

26 SETA

Para cocinar o emplatar.

868810	7	7	3	0,04	Plazos de entrega : 3 a 4 semanas
884034	12	12	1,5	0,08	Plazos de entrega : 3 a 4 semanas

27 NABO

Para cocinar o emplatar.

884105	10	10,5	1,5	0,02	Plazos de entrega : 3 a 4 semanas
--------	----	------	-----	------	-----------------------------------

28 PATATA

Para cocinar o emplatar.

884104	12,5	8	1,5	0,02	Plazos de entrega : 3 a 4 semanas
--------	------	---	-----	------	-----------------------------------

29 CHULETA DE CORDERO

Para cocinar o emplatar.

884013	10	5,5	3	0,04	Plazos de entrega : 3 a 4 semanas
884101	14	4,5	1,5	0,03	Plazos de entrega : 3 a 4 semanas

30 MUSLO DE POLLO

Para cocinar o emplatar.

884031	10	5	3	0,04	Plazos de entrega : 3 a 4 semanas
--------	----	---	---	------	-----------------------------------

Réf.

31 PESCADO

Para cocinar o emplatar.

884015	10	5	3	0,04	Plazos de entrega : 3 a 4 semanas
883907	30	18,5	4,5	0,3	Plazos de entrega : 3 a 4 semanas

32 PESCADO TROPICAL

Para cocinar o emplatar.

884012				0,04	
--------	--	--	--	------	--

33 CABALLO

Para cocinar o emplatar.

884129	16	15,5	1,5	0,07	Plazos de entrega : 3 a 4 semanas
--------	----	------	-----	------	-----------------------------------

34 OSITO DE PELUCHE

Para cocinar o emplatar.

884021	10,5	7,5	3		Plazos de entrega : 3 a 4 semanas
--------	------	-----	---	--	-----------------------------------

35 MARIPOSA

Para cocinar o emplatar.

884019	12	15	3		Plazos de entrega : 3 a 4 semanas
--------	----	----	---	--	-----------------------------------

36 CAJA DE 4 FORMAS DE NAVIDAD

Para cocinar o emplatar.

877310	26	13	3	0,23	Plazos de entrega : 3 a 4 semanas
--------	----	----	---	------	-----------------------------------

37

38

39

40

41

42

43

44

45

46

47

48

Réf.

37 **ÁNGEL**

Para cocinar o emplatar.

884004	8	7	3	0,04	Plazos de entrega : 3 a 4 semanas
--------	---	---	---	------	-----------------------------------

38 **BOTA DE SANTA CLAUS**

Para cocinar o emplatar.

884145	5,5	5	1,5	0,01	Plazos de entrega : 3 a 4 semanas
--------	-----	---	-----	------	-----------------------------------

39 **SURTIDO DE 6 CORTADORES «GALLETAS DE NAVIDAD»**

Con rafia + etiqueta Gobel con receta - acero inoxidable

884154				0,1	Plazos de entrega : 3 a 4 semanas
--------	--	--	--	-----	-----------------------------------

40 **MUÑECO DE NIEVE**

Para cocinar o emplatar.

896730	9	6,5	3	0,04	Plazos de entrega : 3 a 4 semanas
--------	---	-----	---	------	-----------------------------------

41 **MUÑECO DE JENGIBRE (ALSACIA)**

Para cocinar o emplatar.

884115	7,5	5	1,5	0,02	Plazos de entrega : 3 a 4 semanas
--------	-----	---	-----	------	-----------------------------------

884110	10,5	7	1,5	0,03	Plazos de entrega : 3 a 4 semanas
--------	------	---	-----	------	-----------------------------------

884002	14	12	3	0,07	Plazos de entrega : 3 a 4 semanas
--------	----	----	---	------	-----------------------------------

884120	19	14	1,5	0,07	Plazos de entrega : 3 a 4 semanas
--------	----	----	-----	------	-----------------------------------

42 **MUÑECA DE JENGIBRE (ALSACIA)**

Para cocinar o emplatar.

884111	10,5	7	1,5	0,03	Plazos de entrega : 3 a 4 semanas
--------	------	---	-----	------	-----------------------------------

Réf.

884121	19	14	1,5	0,22	Plazos de entrega : 3 a 4 semanas
--------	----	----	-----	------	-----------------------------------

43 **ESTRELLA FUGAZ**

Para cocinar o emplatar.

884141	10	3,5	1,5	0,02	Plazos de entrega : 3 a 4 semanas
--------	----	-----	-----	------	-----------------------------------

884007	14	6	3	0,05	Plazos de entrega : 3 a 4 semanas
--------	----	---	---	------	-----------------------------------

44 **SANTA CLAUS**

Para cocinar o emplatar.

884008	12	6,5	3	0,05	Plazos de entrega : 3 a 4 semanas
--------	----	-----	---	------	-----------------------------------

884128	18	13,2	1,5	0,06	Plazos de entrega : 3 a 4 semanas
--------	----	------	-----	------	-----------------------------------

45 **SAN NICOLÁS**

Para cocinar o emplatar.

884130	20	8,8	1,5	0,06	Plazos de entrega : 3 a 4 semanas
--------	----	-----	-----	------	-----------------------------------

46 **COPO DE NIEVE**

Para cocinar o emplatar.

884108	11,5	10,5	1,5	0,05	Plazos de entrega : 3 a 4 semanas
--------	------	------	-----	------	-----------------------------------

47 **CASITA**

Para cocinar o emplatar.

884142	5,5	5	1,5	0,01	Plazos de entrega : 3 a 4 semanas
--------	-----	---	-----	------	-----------------------------------

48 **RENO DE SANTA**

Para cocinar o emplatar.

884125	16	15,8	1,5	0,07	Plazos de entrega : 3 a 4 semanas
--------	----	------	-----	------	-----------------------------------

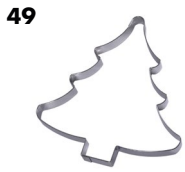

49



50



51



52



53



54



55



56

Réf.

49 **ÁRBOL DE NAVIDAD**

Para cocinar o emplatar.

884127	16	15,8	1,5	0,07	Plazos de entrega : 3 a 4 semanas
884144	6	4,5	1,5	0,01	Plazos de entrega : 3 a 4 semanas
896830	8	8	3	0,04	Plazos de entrega : 3 a 4 semanas
896840	10	10	3	0,05	Plazos de entrega : 3 a 4 semanas
896860	20	19,5	4,5	0,24	Plazos de entrega : 3 a 4 semanas

50 **BOLLO CUGNOLE / ARO CARAMELO**

Para cocinar o emplatar.

883908	26	9,5	4,5	0,21	Plazos de entrega : 3 a 4 semanas
883943	15	7	4,5	0,12	Plazos de entrega : 3 a 4 semanas
883944	32	11	4,5	0,26	Plazos de entrega : 3 a 4 semanas

51 **CAJA DE 4 ARO DE PASCUA**

Para cocinar o emplatar.

873220	26	13	4,5	0,17	Plazos de entrega : 3 a 4 semanas
--------	----	----	-----	------	-----------------------------------

52 **CONEJITO**

Para cocinar o emplatar.

884001	9,5	8,5	3	0,04	Plazos de entrega : 3 a 4 semanas
884132	18,5	10,5	1,5	0,06	Plazos de entrega : 3 a 4 semanas
884122	21	12	1,5	0,06	Plazos de entrega : 3 a 4 semanas

Réf.

53 **CAMPANA**

Para cocinar o emplatar.

896930	7	6,9	3	0,03	Plazos de entrega : 3 a 4 semanas
884123	15,5	15,5	1,5	0,05	Plazos de entrega : 3 a 4 semanas
898960	20	20	4,5	0,23	Plazos de entrega : 3 a 4 semanas

54 **HUEVO**

Para cocinar o emplatar.

884009	8	5,6	3	0,03	Plazos de entrega : 3 a 4 semanas
884131	15	11	1,5	0,04	Plazos de entrega : 3 a 4 semanas
883909	20	14	4,5	0,19	Plazos de entrega : 3 a 4 semanas
883910	30	21	4,5	0,28	Plazos de entrega : 3 a 4 semanas

55 **GALLINA**

Para cocinar o emplatar.

884005	9,5	9	3	0,04	Plazos de entrega : 3 a 4 semanas
884124	15,5	15,5	1,5	0,05	Plazos de entrega : 3 a 4 semanas

56 **GUADALUPE**

Para cocinar o emplatar.

884501	15	10	3	0,1	Plazos de entrega : 3 a 4 semanas
883918	35	23	4,5	0,42	Plazos de entrega : 3 a 4 semanas
883946	45	30	4,5	0,54	Plazos de entrega : 3 a 4 semanas
884712	60	36	6	1,15	Plazos de entrega : 3 a 4 semanas

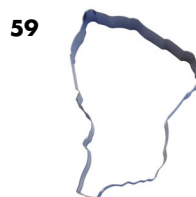
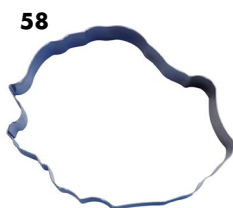

Réf.

57 MARTINICA

Para cocinar o emplatar.

884029	15	9,5	3	0,08	Plazos de entrega : 3 a 4 semanas
883926	25	16	4,5	0,26	Plazos de entrega : 3 a 4 semanas
883927	35	24,5	4,5	0,35	Plazos de entrega : 3 a 4 semanas
883945	45	29	4,5	0,43	Plazos de entrega : 3 a 4 semanas
884713	60	32	6	1,09	Plazos de entrega : 3 a 4 semanas

58 ISLA DE LA REUNIÓN

Para cocinar o emplatar.

884030	15	11,5	3	0,08	Plazos de entrega : 3 a 4 semanas
883924	25	20	4,5	0,25	Plazos de entrega : 3 a 4 semanas
883925	35	26,5	4,5	0,35	Plazos de entrega : 3 a 4 semanas

59 GUAYANA FRANCESA

Para cocinar o emplatar.

884028	15	12	3	0,09	Plazos de entrega : 3 a 4 semanas
883928	25	21,5	4,5	0,19	Plazos de entrega : 3 a 4 semanas
883929	36	27	4,5	0,37	Plazos de entrega : 3 a 4 semanas

60 CÓRCEGA

Para cocinar o emplatar.

884027	15	6	3	0,07	Plazos de entrega : 3 a 4 semanas
883922	25	12	4,5	0,22	Plazos de entrega : 3 a 4 semanas
883930	35	17,5	4,5	0,31	Plazos de entrega : 3 a 4 semanas

Réf.

61 FRANCIA

Para cocinar o emplatar.

883920	16	15	3	0,1	Plazos de entrega : 3 a 4 semanas
883921	27	25,5	4,5	0,32	Plazos de entrega : 3 a 4 semanas
883923	40	38	4,5	0,52	Plazos de entrega : 3 a 4 semanas

62 TORRE EIFFEL

Para cocinar o emplatar.

884107	14	6	1,5	0,03	Plazos de entrega : 3 a 4 semanas
884502	19	9	3	0,11	Plazos de entrega : 3 a 4 semanas
883933	34	15	4,5	0,34	Plazos de entrega : 3 a 4 semanas
883934	57	25	4,5	0,55	Plazos de entrega : 3 a 4 semanas
884709	120	47	6	1,85	Plazos de entrega : 3 a 4 semanas

63 CANADÁ

Para cocinar o emplatar.

883942	25	13	4,5	0,28	Plazos de entrega : 3 a 4 semanas
884711	60	29,5	6	1,1	Plazos de entrega : 3 a 4 semanas

64 ÁFRICA

Para cocinar o emplatar.

883953	35	32,5	4,5		Plazos de entrega : 3 a 4 semanas
--------	----	------	-----	--	-----------------------------------

MARCO A OPERA

Para cocinar o emplatar.

Acero inoxidable

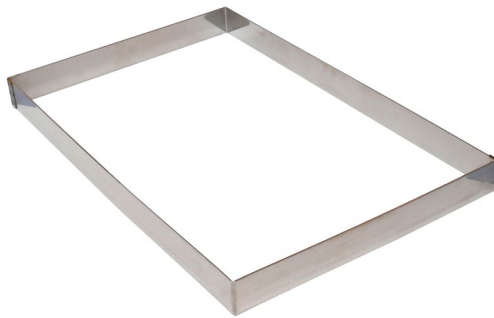

GOBEL

Réf.					
888580	56,5	36,5	6	2,1	20/10
888610	57	9	4,5	0,48	20/10
888620	36	26	4,5	0,87	20/10
888630	40	30	4,5	1,02	20/10
888645	49	29	4,5	1,06	20/10
888650	50,9	30,7	4,5	1,13	20/10
888660	59,5	39,5	4,5	1,6	20/10
888680	56,5	36,5	4,5	1,29	20/10
888750	33	33	3,5	0,7	20/10
888760	50,9	30,7	3,5	0,9	20/10
888780	56,5	36,5	3,5	0,97	20/10

MARCO A OPERA AJUSTABLE EXTENSIBLE

Para cocinar o emplatar. Ajustable de 2 cm a 2 cm.

Acero inoxidable



GOBEL

Réf.				
896470	28	16	4,5	0,56

MARCO CON SEPARADOR EXTRADABLE

Para cocinar o emplatar.

Acero inoxidable

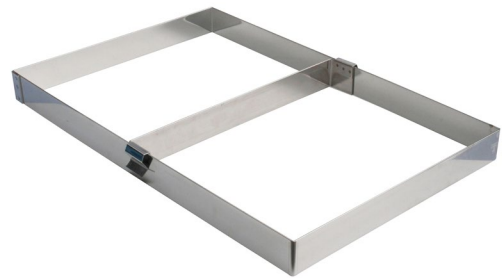

GOBEL

Réf.				
895710	56,5	36,5	4,5	20/10

MOLDE PARA «GÉNOISE»

Borde redondo reforzado

Acero inoxidable



GOBEL

Réf.					
825150	38,6/40	23,6/30	3,5	1	5/10
825160	58,8/60	38,8/40	5	1,42	5/10

MOLDE TRONCO REDONDO TARTA DE NAVIDAD



Folleto de 7 recetas **incluido**

Molde **hermético**

Patentado

Extremos sobremoldeados de silicona **desmontables y antideslizantes**

Fácil
de desmoldear

Compatible
con horno hasta 230°C

Gracias a sus boquillas de silicona, el canalón de acero inoxidable patentado Gobel permite un sencillo desmoldeo y es estanco. Este molde es indispensable para elaborar los troncos de Navidad. Se puede utilizar todo el año para he lados, terrinas, aspics, tejas, etc.

MOLDE TRONCO REDONDO - TARTA DE NAVIDAD

Patentado.
Estanca : fácil desmoldeado. Libreta con recetas incluido

Acero inoxidable



GOBEL



Ref.					
814570	30	8,5	6,8	0,39	1,5 L
814580	50	8,5	6,8	0,65	2,5 L

MOLDE DE NAVIDAD INOX. - FORMA U

1,5 L

Acero inoxidable



GOBEL



Ref.					
800710	30	9	7	0,4	6/10

RASCADORE PARA MOLDE TRONCO DE NAVIDAD 65 X 60 MM

Acero inoxidable



GOBEL



Ref.						
817931	6,5	6	0,1	0,05	L	814570 814580

RASCADORE PARA MOLDE TRONCO DE NAVIDAD 45X50 MM

Acero inoxidable



GOBEL



Ref.						
817932	4,5	5	0,1	0,04	M	814570 814580

RASCADORE PARA MOLDE TRONCO DE NAVIDAD 25X40 MM

Acero inoxidable



GOBEL



Ref.						
817933	2,5	4	0,1	0,03	S	814570 814580

LOTE DE 3 RASCADORES PARA MOLDE TRONCO DE NAVIDAD

Acero inoxidable



GOBEL



Ref.						
817930	6,5	6	0,3	0,12	Juego de las 3	814570 814580



BANDEJAS DE PASTELERÍA

BANDEJAS DE PASTELERÍA

267

BANDEJA DE PASTELERÍA PERFORADA

FRANCE 1827
GOBEL
 rien ne remplace le fait main



Micro perforación

Permite evacuar el exceso de humedad para la cocción de las masas congeladas y preserva el crujiente

Favorece la circulación de aire caliente en el horno y alrededor de las hojas de cocción

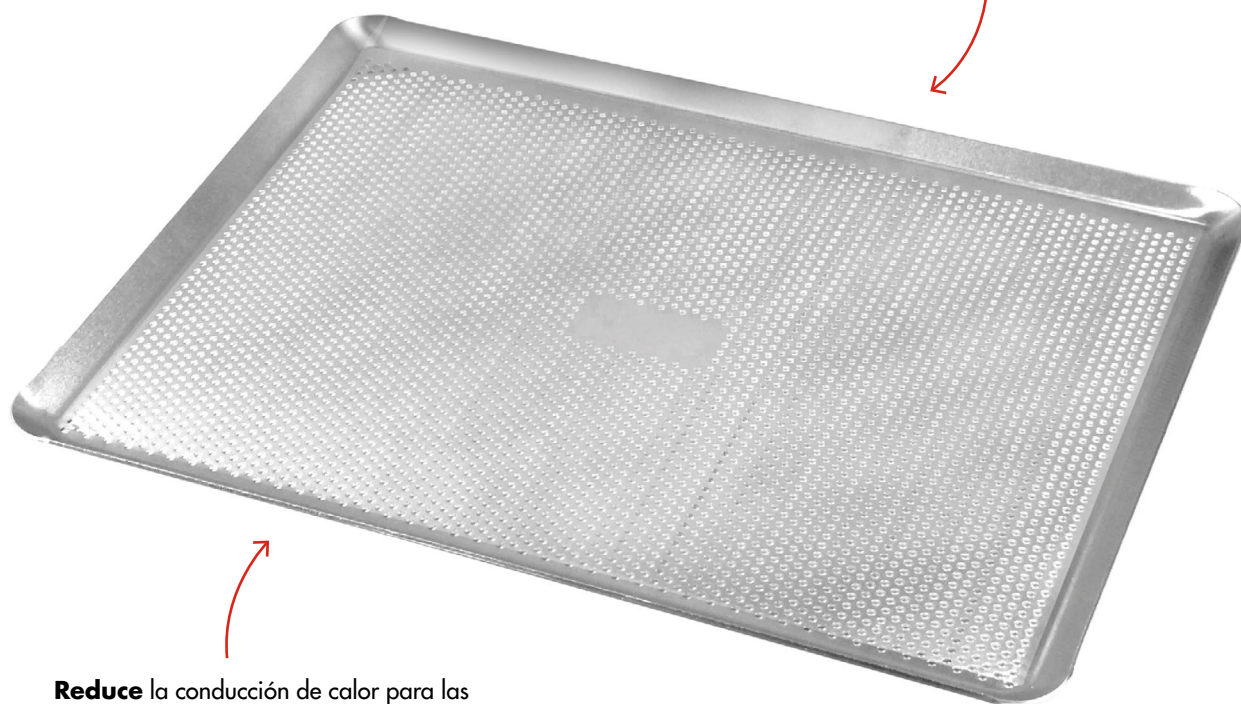

Reduce la conducción de calor para las preparaciones delicadas (macarrones)

Las placas de bordes pinzados de GOBEL están disponibles en acero inoxidable, aluminio y aluminio con revestimiento antiadherente.

Indispensables para la cocción en el horno, también sirven de soportes de preparación y de almacenamiento en los armarios fríos y las cámaras de fermentación.

BANDEJA DE PASTELERÍA INOX.

Las placas pastelería de acero inoxidable son aptas para el lavavajillas, el horno (temperatura máxima de cocción: 300°C/572°F) y el frigorífico (-20°C +6°C / -4°F +42,8°F). Son Ideales para almacenamiento.

Acero inoxidable



GOBEL



Réf.						> <
814550	40	30	1	0,9		10/10
814560	53	32,5	1	1,35	GN 1/1	10/10
814590	60	40	1	1,87		10/10

BANDEJA DE PASTELERÍA CON BORDES RECTOS

Imprescindible para cocinar.

Acero inoxidable



GOBEL



Réf.						> <
814565	53	32,5	2	1,6	GN 1/1	10/10
814595	60	40	3	2,05		10/10

BANDEJA DE PASTELERÍA - ALUMINIO

Aluminio



GOBEL



Réf.					> <
614530	40	30	1	0,64	8/10
614580	53	32,5	1	0,71	8/10
614590	60	40	1	1	8/10

BANDEJA DE PASTELERÍA ANTIADHERENTE

Las placas pasteleras de aluminio con revestimiento antiadherente combinan la conductividad del calor del aluminio y la excelente antiadherencia del revestimiento de 4 capas, sin PFOA, que hace innecesaria la utilización de papel de cocción. El grosor de estas placas, el material y la calidad del revestimiento le permitirán utilizarlas durante mucho tiempo y le darán una satisfacción permanente.

Aluminio revestido antiadherente



GOBEL



Réf.						> <
714510	30	15	1	0,25		18/10
714530		40	30	1	0,65	18/10
714560	53	32,5	1	0,92	GN 1/1	18/10
714590	60	40	1	1,17		18/10
714595	65	53	1	1,93		20/10

BANDEJA DE PASTELERÍA PERFORADA - ALUMINIO

Aluminio

GOBEL

Réf.					
615530	30	40	1	0,37	8/10
615580	53	32,5	1	0,54	8/10
615590	60	40	1	0,73	8/10

BANDEJA DE PASTELERÍA PERFORADA SIN BORDES

Aluminio

GOBEL

Réf.					
615535	30	40	0,1	0,38	8/10





GOBEL[®]

2.5QT — 2.5L
2.0QT — 2.0L

UTENSILIOS DE REPOSTERÍA

BOL PARA MEZCLAR	272
TELAS PARA HORNEAR Y RODILLOS DE REPOSTERÍA	273
BATIDORES, ESPÁTULAS, CUCHARAS Y BROCHAS	275
MANGAS PASTELERAS Y BOQUILLAS	278
SIFÓNES Y RECARGAS	283
ESPATULA CORTOPASTA	284
CORTAPASTA	286
CEDAZOS, ESPOLVOREADORES, DISPOSITIVOS DE DOSIFICACIÓN Y COLADOR «CHINO»	289
OTRAS HERRAMIENTAS	293

BOL SEMI-ESFÉRICO CON BASE ANTIDESLIZANTE

Base de silicona para un mejor agarre sobre el plan de trabajo.

Acero inoxidable y silicona

GOBEL

Réf.				
GL303	16	10,3	0,2	16 cm
GL20P004	20	12	0,28	20 cm
GL20P005	24	14	0,4	24 cm

BOL SEMI-ESFÉRICO - TAPADERA / BASE DE PP

Graduado. La tapa se convierte en base antideslizante.

4 L

Cubierta de base, gris hecha en Francia

Acero inoxidable, TPR

GOBEL

Réf.			
GL20P003	24	15	0,7

BOL DE FONDO REDONDO

Acero inoxidable

GOBEL

Réf.			
GL312	10	0,21	16
GL313	12	0,32	20
GL329	0,4	24	
GL314	17,5	0,9	30
GL315	24,5	1,55	40

BARREÑO DE FONDO PLANO

Acero inoxidable

GOBEL

Réf.			
GL316	8,5	0,21	16
GL317	10	0,33	20
GL318	11	0,5	24
GL319	12,5	0,61	28
GL320	14,5	0,71	32

JARRA GRADUADA

Con asa y pico vertedor. Graduación en cl y pt.

Acero inoxidable

0,10 l



Réf.				
NS007	15,5	14	0,24	1 L

TELAS PARA HORNEAR

Para cocción y preparación. Antideslizantes, antiadherentes.

Tela de vidrio recubierta de silicona platino

-40°C + 260°C / -40°F +500°F

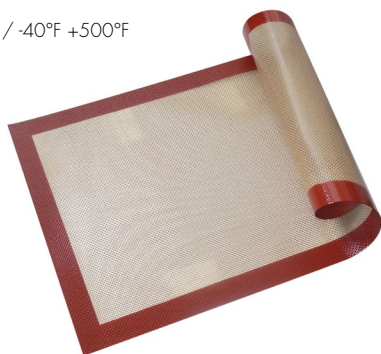

LOUIS TELLIER

Réf.				
NCS011	31	52	0,13	
NCS301		30	40	0,12
NCS601	38,5	58,5	0,19	

TELAS PARA HORNEAR - GOBEL

Para cocinar y preparar. Antideslizante y antiadherente.

Tela de vidrio recubierta de silicona platino

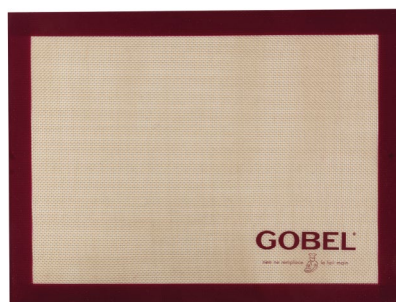

GOBEL

Réf.			
GL304	40	30	0,11
GL305	58	38,5	0,21
GL306	51,5	31	0,15

RODILLO DE REPOSTERÍA INOX.

Anchura útil: 25 cm. Pesado, calidad profesional.

Acero inoxidable



LOUIS TELLIER

Réf.			
N3720	6,5	1,8	Con mangos ovalados

RODILLO DE REPOSTERÍA DE HAYA

Madera maciza. Certificado PEFC.

Madera de haya - PEFC



GOBEL

Réf.			
NRP43	5	0,5	43 cm
NRP47	5	0,6	47 cm
NRP50	5	0,75	50 cm

RODILLO DE REPOSTERÍA DE HAYA - GOBEL

Ideal para retail tienda. Madera maciza.

Madera de haya



GOBEL

Réf.		
GB20P009	5	45 cm - Con vaina packaging

RODILLO DE REPOSTERÍA DE HDPE

Higiénico, fácil de limpiar.

HDPE



LOUIS TELLIER

Réf.			
NRPP45	5	0,64	45 cm
NRPP50	5	0,7	50 cm

BATIDOR PROFESIONAL

GRANDE 1882
GOBEL
rien ne remplace le fait main



Alambres de acero inoxidable que **no se separan** del mango **ni se retuercen**.

Gran resistencia al arrancamiento
(pruebas superiores a 80 kg).

La forma abombada* del mango permite el **paso** y la **evacuación** del líquido de lavado entre los alambres

Collarín **apoya batidor**

Estanqueidad* **perfecta y total** (conforme a las exigencias de higiene de los servicios de control). Sobremoldeado integral del mango.

Mango* **aislante microtáctil** agradable al tacto. Apto para el contacto alimentario

Forma octogonal* y ensanchada hacia arriba para una **sujeción máxima** : anti fatiga y anti crispación

Este batidor profesional es ligero, equilibrado y manejable. Responde a todas las exigencias en materia de higiene y limpieza. El mango ergonómico y est anco ofrece comodidad de utilización y resistencia. Duradero : adaptado a una utilización intensiva.

*Todas estas características son objeto de un registro de patente.

BATIDOR PROFESIONAL

Patentado, apto para lavavajilla. Mango estanco antideslizante. Ligero, equilibrado y manejable.

8 hilos

Hilo de acero inoxidable

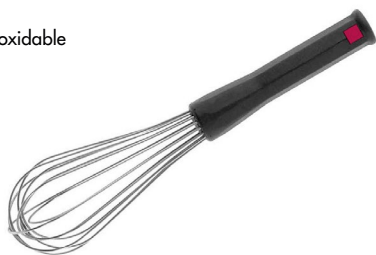

GOBEL

Réf.	↔	↙	📦	🔍
NC070	25	6	0,09	25 cm
NC071	30	8	0,11	30 cm
NC072	35	8	0,18	35 cm
NC073	40	9	0,2	40 cm
NC074	45	10	0,24	45 cm
NC075	50	11	0,26	50 cm

BATIDOR DE BOLA PARA CLARAS

Patentado, apto para lavavajilla. Mango estanco antideslizante.

8 hilos

Hilo de acero inoxidable



GOBEL

Réf.	↔	↙	📦	🔍
NC076	35	10	0,2	35 cm
NC077	45	12	0,22	45 cm

CUCHARA - ESPÁTULA DE SILICONA

La gama de espátulas «PASIÓN», en colores gourmet, para los aficionados de la cocina!

Silicona



GOBEL

Réf.	↔	↙	⊥	📦
GL19P013	27,5	6	1,4	0,08

ESPÁTULA GRANDE DE SILICONA

La gama de espátulas «PASIÓN», en colores gourmet, para los aficionados de la cocina!

Silicona



GOBEL

Réf.	↔	↙	⊥	📦
GL19P014	27,5	5,5	1,4	0,07

ESPÁTULA PEQUEÑA DE SILICONA

La gama de espátulas «PASIÓN», en colores gourmet, para los aficionados de la cocina!

Silicona



GOBEL

Réf.	↔	↙	⊥	📦
GL19P015	26,5	4	1,4	0,06

CEPILLO DE COCINA DE SILICONA

La gama de espátulas «PASIÓN», en colores gourmet, para los aficionados de la cocina!

Silicona



GOBEL

Réf.	↔	↙	⊥	📦
GL19P016	27,5	5,5	1,4	0,08





ESPÁTULA TORNEADA 30 CM MACIZA - GOBEL

Certificado PEFC.

 Madera de haya



GOBEL

Réf.				
GL307	30	7	0,5	0,03





ESPÁTULA TORNEADA CON ORIFICIO - GOBEL

Certificado PEFC.

 Madera de haya



GOBEL

Réf.				
GL308	30	6,7	0,5	0,04





ESPÁTULA TORNEADA CON RANURA - GOBEL

Certificado PEFC.

 Madera de haya



GOBEL

Réf.				
GL309	30	6,8	0,5	0,04





ESPÁTULA BISELADA - GOBEL

Certificado PEFC.

 Madera de haya



GOBEL

Réf.				
GL328	35	5	0,7	0,03





ESPÁTULA REDONDA - GOBEL

Certificado PEFC.

 Madera de haya



GOBEL

Réf.				
GL327	35	4,6	0,6	0,03





CUCHARA DE COCINA - GOBEL

Certificado PEFC.

 Madera de haya



GOBEL

Réf.				
GL326	35	4,8	1,5	0,05

PAR DE CUBIERTOS DE ENSALADA - GOBEL

Certificado PEFC.

Madera de haya



GOBEL

Réf.	↔	↗	⊥	📦
GL311	25,5	5,8	1,2	0,05

PINZA DE TOSTADA - GOBEL

Certificado PEFC.

Madera de haya



GOBEL

Réf.	↔	↗	⊥	📦
GL310	24	2,5	1,5	0,02

PINCEL PLANO

4 tamaños.

Mango de madera, seda natural, virola de acero inoxidable



GOBEL

Réf.	↔	📦	🔍
317020	22,5	0,02	Cerda 25 mm
317030	23,5	0,03	Cerda 35 mm
317040	24,5	0,04	Cerda 40 mm
317050	25,5	0,06	Cerda 50 mm

BROCHA DE SEDA MANGO DE MADERA

Cerda: 50 mm. Cerdas suave de seda natural.

Madera de haya, virola de acero inoxidable, cerdas de seda natural



Réf.	↔	📦	🔍
NP20-1	20,5	0,07	20 mm
NP25-1	21,5	0,09	25 mm
NP30-1	22,5	0,11	30 mm
NP35-1	23	0,17	35 mm
NP40-1	23,5	0,14	40 mm

BROCHA DE SILICONA

Limpieza fácil. Resistente hasta 230°C.

Silicona, mango de acero inoxidable



Réf.	↔	📦
NPS22	22	0,1

BOQUILLA ESTRELLA 5 MM - 6 RAMAS

Acero inoxidable

GOBEL

Réf.			
815310	0,5	0,01	6 ramas

BOQUILLA PARA RELLENO

Tubo : 40 mm. Punta biselada.

Acero inoxidable

GOBEL

Réf.			
815410	0,8	0,07	
815420	0,8	0,09	

BOQUILLA ESTRELLA 6 MM - 6 RAMAS

Acero inoxidable

GOBEL

Réf.		
815510	0,6	0,01

BOQUILLA CINTA ESTRELLA - 8 RAMAS

Acero inoxidable

GOBEL

Réf.			
815610	2	0,01	8 ramas

BOQUILLA ESTRELLA 6 MM - 8 RAMAS

Acero inoxidable

GOBEL

Réf.		
815810	0,6	0,01

BOQUILLA REDONDA 1 MM

Acero inoxidable

GOBEL

Réf.			
815210	0,1	0,01	∅ 1 mm

BOQUILLA REDONDA 8 MM

Acero inoxidable



GOBEL

Réf.			
815220	0,8	0,01	Ø 8 mm

BOQUILLA REDONDA 14 MM

Acero inoxidable



GOBEL

Réf.			
815230	0,14	0,01	Ø 14 mm

BOQUILLA «SAINT HONORÉ»

Acero inoxidable



GOBEL

Réf.	
815850	0,01

CAJA CRISTAL DE 6 BOQUILLAS

Juego de 6 boquillas de acero inoxidable : redonda 1 mm - redonda 8 mm - estrella 5 mm 6 ramas - estrella 6 mm 6 ramas - cinta estrella - estrella 6 mm 8 ramas

Acero inoxidable



GOBEL

Réf.		
888002	13 7 8,5	0,09

JUEGO DE 6 GRANDES BOQUILLAS PARA ESPECIALIDADES

Dim. (n°) PF10 - PF14 - Estrella 8 ramas - Flor - Redonda - Saint-Honoré

Tritan



GOBEL

Réf.	
308730	0,07

MANGA PASTELERA DE CUTÍ

Muy flexible y fácil de manejar.

Algodón de calidad alimentaria



GOBEL

Réf.		
313110	25	0,02
313120	30	0,02
313130	35	0,03
313140	40	0,03
313160	50	0,04

MANGA PASTELERA - ALGODÓN REVESTIDO

Algodón revestido

GOBEL

Réf.	↔
GL321	30
GL322	35
GL323	40
GL324	45
GL325	50

KIT PARA MASA «PÂTE À CHOUX»

Incluido : 1 boquilla redonda 8 mm + 1 boquilla estrella 5 mm + 1 boquilla para relleno corta + 1 manga de nylon 400 mm + recetas

Acero inoxidable y nylon

GOBEL

Réf.	📦
889030	0,06

CAJA REDONDA DE 6 BOQUILLAS INOX + 1 MANGA DE NYLON

Juego de 6 boquillas de acero inoxidable + 1 manga de nylon 300 mm

Acero inoxidable y nylon

GOBEL

Réf.	↔	⤴	📦
889052	12	4	0,11

CAJA CRISTAL DE 6 BOQUILLAS INOX + 1 MANGA DE NYLON

Juego de 6 boquillas de acero inoxidable + 1 manga de nylon 300 mm

Acero inoxidable y nylon

GOBEL

Réf.	↔	⤴	⤵	📦
889251	13	7	8,5	0,09

BLISTER DE DECORACIÓN

Juego de 6 boquillas inox + 1 manga de nylon 300 mm

Acero inoxidable y algodón

GOBEL

Réf.	↔	⤴	⤵	📦
889210	31,5	14,5	4	0,12

CAJA TRANSPARENTE DE 6 BOQUILLAS INOX + 1 MANGA DE CUTI

Juego de 6 boquillas de acero inoxidable + 1 manga de cuti 300 mm

Acero inoxidable y algodón

GOBEL

Réf.	↔	⤴	⤵	📦
889151	13	7	8,5	0,11

CAJA REDONDA DE 6 BOQUILLAS INOX + 1 MANGA DE CUTI

Juego de 6 boquillas de acero inoxidable + 1 manga de cuti 300 mm

Acero inoxidable y algodón



GOBEL



Réf.			
889002	12	4	0,11

BLISTER DE DECORACIÓN

Juego de 6 boquillas de acero inoxidable + 1 manga de cuti 250 mm

Acero inoxidable y algodón



GOBEL



Réf.				
889101	31,5	14,5	4	0,12

SIFÓN SEMI-PRO KAYSER

KAYSER



Para preparaciones calientes
máx. 70°C

Apto para
el **lavavajillas**

Para chantilly, salsas
y emulsiones calientes y frías,
saladas y dulces

Fabricado en **EU**





Herramientas indispensables de creatividad para los chefs y las empresas de catering, también es una forma de crear efecto por un menor coste : se necesita poca materia prima para elaborar cientos de vasitos. Útiles para todos los platos de la carta : aperitivos, vasitos, entrantes, acompañamientos, salsas, natas, mousses... a base de foie-gras, mariscos, verduras, nata infusionada.

Todas las piezas del cabezal se desmontan para una higiene óptima.

SIFÓN SEMI-PRO KAYSER

Para nata montada, salsas y espumas frías. El tanque es apto para lavavajillas. Todas las piezas del cabezal se limpian a mano.

 Tanque de acero inoxidable, aluminio

 + 1°C a +30°C / +33.8°F a +86°F



KAYSER

Ref.			
N4083X	31	0,65	0,5 L
N4084X	35	0,8	1 L

SIFÓN PRO KAYSER

Emulsiones creativas calientes, frías, saladas o dulces. Todas las piezas del tanque y del cabezal son aptas para lavavajillas.

 Acero inoxidable

 + 1°C a +70°C / +33.8°F a +158°F



KAYSER







Ref.			
N4086X	31	0,75	0,5 L
N4087X	 35	1	1 L

RECARGAS KAYSER PARA SIFÓN

 Acero reciclable



KAYSER

Ref.				
NK001	 0,18	0,18	0,65	x50
NK002	 0,18	0,18	0,65	x24
NK003	 2	2	6,5	x10

BICICLETTA CORTADORA AJUSTABLE - DIVISOR DE PASTA

Para cortar al mismo tiempo varias bandas regulares de pasta. Ancho flexible. Ajustable al tamaño deseado .

Acero inoxidable



Réf.		
N3703	0,52	6 ruedas
N37031	0,52	5 ruedas
N37032	0,52	7 ruedas

ESPÁTULA CORTAPASTA INOX.

Calidad de corte. Cuchillo : 15 cm.

Acero inoxidable



Réf.					
N3725	15	12	3	0,16	Cuchilla rigido graduado

ESPÁTULA CORTAPASTA - MANGO DE PP

Cuchilla de inox., mango de plastico. Calidad profesional.

Mango de PP, hoja de acero inoxidable



Réf.					
N3730	12,4	11	1,5	0,07	Cuchilla flexible
N3731	12,4	11	1,5	0,88	Cuchilla rigida

ESPÁTULA CORTAPASTA - MANGO DE PP - CUCHILLA FLEXIBLE

Cuchilla de inox., mango de plastico. Calidad profesional.

Mango de PP, hoja de acero inoxidable



Réf.					
N3738	11,5	11	3	0,66	Cuchilla flexible

ESPÁTULA BLANCA

Para raspar el fondo de un bol o bol y recuperar todo el material o traspasar una preparación de un recipiente a otro.

PP



Réf.				
317910	12	9	0,02	Blanco - Rigido

ESPÁTULA ROJA

Para raspar el fondo de un bol o bol y recuperar todo el material o traspasar una preparación de un recipiente a otro. También le permite cortar piezas de masa.

PP

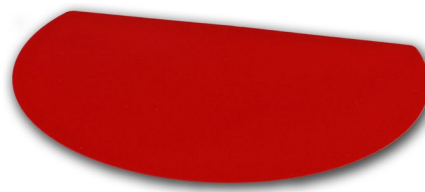

Réf.				
317920	16	12	0,02	Rojo - Flexible

RODILLO PINCHO

Calidad y productividad superiores. Ergonómicos.

ABS



Réf.				
N3726	22	10	7,5	0,22

PINZA PARA MASA INOX.

Acabado acanalado. Para pellizcar los bordes de las tartas.

Acero inoxidable



Réf.		
PAP3	9,5	0,3

CORTAPASTA CON MANGO

Acero inoxidable



GOBEL

Réf.						
896330	10	6,5	9	0,16	Corta-croissant modelo pequeño	
896350		20	10	9	0,24	Corta-croissant modelo grande

RODILLO PARA CRUASANES

Triangulos regulares de masa de hojaldre.

Acero inoxidable, mango de madera



LOUIS TELLIER

Réf.				
N3728	34	8	0,3	Mini-croissant
N3728-2	44	9,5	0,44	Croissant

CORTAPASTA REDONDO ACANALADO CON BORDE ENROLLADO

Para un corte limpio de cualquier tipo de masa (hojaldre, mantecados, bizcochos, etc.).

Acero inoxidable

GOBEL

Réf.	∅	I	Peso	Detalle
844910	3	3,6	0,01	Rizado
844920	4	3,6	0,02	Rizado
844930	5	3,6	0,02	Rizado
844940	6	3,6	0,02	Rizado
844950	7	3,6	0,03	Rizado
844960	8	3,6	0,03	Rizado
844970	9	3,6	0,04	Rizado
844980	10	3,6	0,05	Rizado

CORTAPASTA REDONDO LISO CON BORDE ENROLLADO

Para un corte limpio de cualquier tipo de masa (hojaldre, mantecados, bizcochos, etc.).

Acero inoxidable

GOBEL

Réf.	∅	I	Peso	Detalle
845010	3	3,6	0,01	Liso
845020	4	3,6	0,02	Liso
845030	5	3,6	0,02	Liso
845040	6	3,6	0,02	Liso
845050	7	3,6	0,03	Liso
845060	8	3,6	0,03	Liso
845070	9	3,6	0,04	Liso
845080	10	3,6	0,04	Liso
845090	11	3,6	0,05	Liso

CAJA DE 8 CORTAPASTAS REDONDOS ACANALADOS

Acero inoxidable

GOBEL

Réf.	∅	I	Peso	Detalle
880001	3 -> 10	4	0,25	Caja de 8 cortapastas rizados

CAJA DE 8 CORTAPASTAS REDONDOS LISOS

Acero inoxidable

GOBEL

Réf.	∅	I	Peso	Detalle
880101	3 -> 11	4	0,25	Caja de 8 cortapastas lisos

CAJAS Y LOTES DE CORTADORES

5 cortadores : 4,3 x 4,3 x 6,5 cm - 5,7 x 5,7 x 7 cm - 7 x 7 x 7,5 cm - 8 x 8 x 8 cm - 9,2 x 9,2 x 8,5 cm.

Mango

Acero inoxidable



Réf.	Peso	Detalle
887902	0,23	Estrellados

CORTAPASTA CON MANGO

Acero inoxidable

GOBEL

Réf.	∅	I	Peso	Detalle
845130	22	4,2	0,28	Roscón de Reyes
845140	24	4,2	0,3	Roscón de Reyes
845150	26	4,2	0,32	Roscón de Reyes
845160	28	4,2	0,34	Roscón de Reyes

CORTAPASTA CON MANGO PARA HOJALDRES RELLENOS DE MANZANA

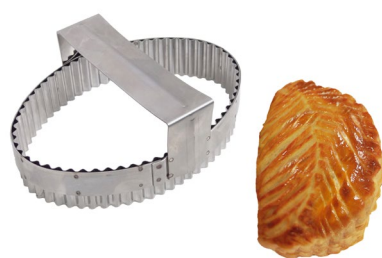
 Acero inoxidable







GOBEL

Réf.					
845170	17	12	0,6	0,2	Empanada de manzana

CORTAPASTA CON MANGO PARA HOJALDRES MOLINOS DE VIENTO

 Acero inoxidable

GOBEL





Réf.					
845180	11	11	9,5	0,23	Molino de viento

CORTAPASTA CON MANGO PARA BROWNIE

Para 42 unidades (25 x 25 mm).

 Acero inoxidable

GOBEL



Réf.				
845200	20	12,5	9,5	0,7

CORTADORES DE PASTEL

Para cortar 6 partes iguales a la vez.

 Acero inoxidable





GOBEL

Réf.			
N3716	25,5	0,33	6 secciones

CALISSON

 Acero inoxidable

GOBEL

Réf.				
884042	4,5	2,8	3	0,02
884043	5,3	5,3	3	0,02
884201	7	3,8	4	0,03
884202	8,3	4,7	4	0,04

TAMIZ DE 3 MALLAS

FRANCE 1887
GOBEL
 rien ne remplace le fait main

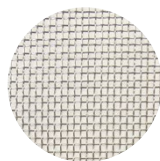

n°16



n°20

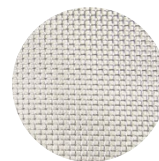

n°25

3 mallas **disponibles** :
 n°16, 20, 25

Acero inox.



Tamiz **desmontable** con
 telas **intercambiables**



Indispensable
 en pastelería

Tensión óptima de la malla en el
 interior de las dos piezas del tamiz
 gracias al **sistema de fijación**

Higiene

Este tamiz de 3 piezas de inox. es higiénico y fácil de usar.

La malla n°25 (vacío de malla de 0,9 mm) es una rejilla fina para el azúcar glas, la harina o el cacao.

La malla n°20 (vacío de malla de 1,1 mm) es una rejilla media para las almendras o las avellanas molidas.

La malla n°16 (vacío de malla de 1,4 mm) es una rejilla ancha para filtrar las salsas, coulis, gelatinas, y tamizar los purés o preparados para eliminar la espuma.

CEDAZO CON 3 MALLAS

3 mallas: paso 25 - fina, paso 20 - media y paso 16 - gruesa. Malla extraíble e intercambiable. Modelo doméstico.

Acero inoxidable



Réf.		
NC5062860	20	0,46

CEDAZO 1 PIEZA

Malla media - paso 20 (malla 1,1 mm). Tensión máxima de la malla, engastada sólidamente en la corona.

Acero inoxidable



Réf.				
NC014	20	0,25	Ø 20 cm	
NC015		30	0,27	Ø 30 cm

CEDAZO 3 PIEZAS

Tela intercambiable y tensión óptima.

Acero inoxidable



Réf.					
NC012		30	1	Malla media - paso 20	
NC5060760		30	1	Malla fina - paso 25	
NC5064660		40	1,18	Malla media - paso 20	
NC5064760		40	6	1,2	Malla fina - paso 25

TELA DE RECAMBIO

Acero inoxidable



Réf.				
NC013	30	0,02	Malla media - paso 20	NC012
NC5061760	30	0,24	Malla fina - paso 25	NC5060760
NC5065660	40	0,32	Malla media - paso 20	NC5064660
NC5065760	40	0,38	Malla fina - paso 25	NC5064760

ESPOLVOREADORES - TELA

Ideal azúcar glas o cacao. Tapa transparente.

Acero inoxidable



Réf.					
N3705		7	9,5	0,12	Tela

ESPOLVOREADORES - 2 MM

Ideal azúcar glas o cacao. Tapa transparente.

Acero inoxidable



Réf.				
N3707	7	9,5	0,12	Ø 2 mm

COLADOR «CHINO»

FRANCE 1887
GOBEL
 rien ne remplace le fait main

Made in France



Cono de tela fina **acero inoxidable** 304 tejido, abertura 0,45 x 0,45 mm

Muy robusto : fijación sólida de la tela al cuerpo por un **doble engaste**

Conjunto remachado

Estañado **profundo**

El gancho, el refuerzo y el mango son de una **sola** pieza.



El colador Gobel es la herramienta profesional imprescindible para la filtración de todas las preparaciones (caldos, coulis, emulsiones, sopas, salsas, etc.) y obtener una textura ideal sin residuos.

Está disponible un mortero de madera de haya, que se vende por separado, para facilitar el paso de preparativos.

CEDAZO PARA HARINA

Acero inoxidable



Réf.			
N3711	10,5	14,5	0,22

JARRA GRADUADA

Con asa y pico vertedor. Graduación en cl y pt.

Acero inoxidable

0,10 l



Réf.				
NS008	18	20	0,39	2 l

VASO DOSIFICADOR

5 escalas: líquidos, harina, azúcar, sémola, fécula.

250 ml

PP



Réf.	
DO1250	0,04

COLADOR «CHINO» - ESTAÑADO

Le permite filtrar salsas, sopas, jarabes, etc.

Hojalata



GOBEL

Réf.				
114010	20	22	0,38	Sin refuerzo - sin gancho

COLADOR «CHINO» - CON GANCHO - ESTAÑADO

Le permite filtrar salsas, sopas, jarabes, etc.

Hojalata



GOBEL



Réf.			
114110	20	22	0,4

COLADOR «CHINO» - CON REFUERZO Y GANCHO - ESTAÑADO

Le permite filtrar salsas, sopas, jarabes, etc.

Hojalata



GOBEL



Réf.				
114410	20	26,5	0,56	Con refuerzo - con gancho

COLADOR «CHINO» - CON REFUERZO Y GANCHO - INOX.

Con refuerzo y gancho de acero inoxidable - cuerpo y cola de acero inoxidable

Acero inoxidable

GOBEL

Ref.		
814410	20	0,55

SOPORTE PARA COLADORES CHINOS

Adaptado para los chinos coladores Ø 20 cm.

Hilo de acero inoxidable



Ref.			
N3020	18	28	0,3

PISÓN DE MADERA PARA COLADOR «CHINO»

Certificado PEFC.

Madera de haya

GOBEL

Ref.		
317310	3,74	0,46

SOPLETE DE COCINA

Rellenable. Botón de bloqueo. Modo continuo y intensidad regulable.

Base extraíble

Acero inoxidable, ABS



GOBEL

Réf.				
N3924	12,5	12,5	17	0,33

ANTORCHA SOPLETE PROFESIONAL

Soplete de gas. Botón de encendido, atenuador y cierre de seguridad. Para asar, caramelizar, derretir ...

Acero, nylon



GOBEL

Réf.					
GL19P011	13	6,5	6,5	0,16	Botella de gas no incluida

REJILLA TEJIDA REDONDA PARA TARTAS - INOX.

Para enfriar tartas y pasteles a la salida del horno: para quitar humedad e impedir ablandamiento. Ideales para rebozar, glazear, pulverizar o escurrir.

Acero inoxidable



LOUIS TELLIER

Réf.			
NC007	24	0,1	Ø 24 mm

REJILLA TEJIDA REDONDA

Para enfriar tartas y pasteles a la salida del horno: para quitar humedad e impedir ablandamiento. Ideales para rebozar, glazear, pulverizar o escurrir.

Acero inoxidable



LOUIS TELLIER

Réf.				
NC008	28	2,5	0,1	Ø 28 mm
NC009	32	0,18		Ø 32 mm
NC027	20	0,1		Ø 20 mm
NC028	36	3,5	0,26	Ø 36 mm

REJILLA TEJIDA CUADRADA

Adecuadas para los moldes para tartas y los moldes de manqué rectangulares o cuadrados. Ideal para rebozar, glazear, pulverizar o escurrir.

Acero inoxidable

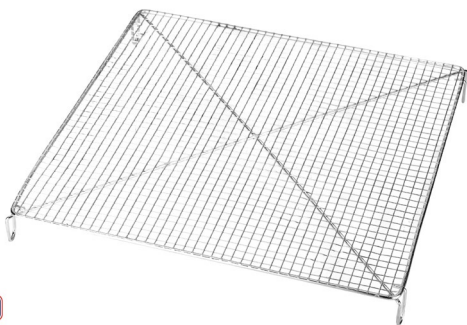

LOUIS TELLIER

Réf.				
NC1053860	26	26	0,18	Cuadrada

REJILLA TEJIDA RECTANGULAR PARA TARTAS

Adecuadas para los moldes para tartas y los moldes de manqué rectangulares o cuadrados. Ideal para rebozar, glazear, pulverizar o escurrir.

Acero inoxidable

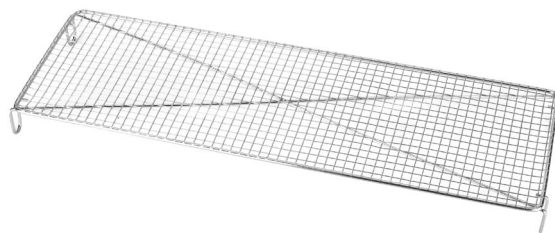

LOUIS TELLIER

Réf.				
NC1053960	36	12	0,13	Rectangular

REJILLA TEJIDA RECTANGULAR

Adecuadas para los moldes para tartas y los moldes de manqué rectangulares o cuadrados. Ideal para rebozar, glazear, pulverizar o escurrir.

Acero inoxidable

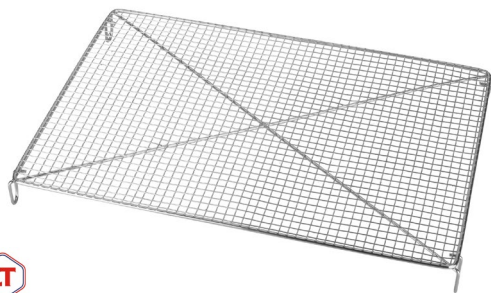

Réf.				
NC1054060	30,5	22	0,16	Rectangular

EMBUDO AUTOMÁTICO DOSIFICADOR

Muy útil para llenar moldes, matrices y vasos de líquidos (almíbar, crema, masa fluida, chocolate, salsas). 3 boquillas adaptadas a la consistencia variable. Porcionar al presionar el mango. Se queda estanco cuando está cerrado.

1,3 L

Con soporte, 3 enchufes

Acero inoxidable



Réf.			
N3715	18,5	0,97	Cono de 16 cm

TENEDORES PARA CHOCOLATE

Para coger, bañar o marcar los chocolates redondos, rectangulares o cuadrados. Se pueden retorcer si se necesita.

Acero inoxidable, mango de ABS



Réf.						
ID5000			0,12	Juego de 4 modelos		
ID5001		18	2	2	0,25	Redonda
ID5002		20	3	2	0,24	Espiral
ID5003		19	2	1,5	0,22	2 dientes
ID5004					0,25	3 dientes

PRENSA PARA GALLETAS IMPERIA

Dosificaciones calibradas: raciones iguales y con el mismo peso. Empuñadura pistola: con una sola mano.

0,3L

4 boquillas y 14 discos de patrones creativos

Aluminio



Réf.		
N7919	5	0,7

SPRAY DE FÁCIL DESMOLDEO

Sin sabor ni olor. Basado en aceite de colza. Ideal para todo tipo de moldes, platos, esteras para hornear y equipos de cocina (sartén, planchas...) sin riesgo de salpicaduras de aceite.

250 ml

Aceite vegetal

220°C



GOBEL



Réf.		
GL19P017	5,3	23,5

CUENTAS PARA MASA DE TARTAS

Ideales para hornear las bases de tartas evitando que la masa se infle.

Acero inoxidable



Réf.		
NC5020760	10,5	11,5

EMBUDO AUTOMÁTICO DE ÉMBOLO



El embudo automático de émbolo facilita el llenado de los moldes, formas y verrinas líquidas (fondant, chocolate, sirope, coulis, crema, masa líquida, salsas).

Incluye 1 soporte y 3 boquillas (para adaptarse a la consistencia de los preparados).

FRANCE 1887
GOBEL
rien ne remplace le fait main
ORIGINE

MATÉRIAU 100% BIODÉGRADABLE
Moule en **papier naturel**
Compostable à la maison*

DÉMOULAGE FACILE ET RAPIDE
• Sans matière grasse, démoulage parfait
• Qualité professionnelle
• Le moule naturel utilisé en **boulangerie**
enfin **accessible** au grand public

EXCELLENT CONDUCTEUR DE CHALEUR
• Cuisson parfaite et homogène
• Montée de la chaleur rapide, jusqu'à 220°C
* Moule tarte et tartelette

LE CONSEIL DU CHEF
Idéal pour vos événements (pique-nique, anniversaire...)
pour des recettes sucrées et salées!

UTILISATION
• Usage unique
• Cuisson au four et au micro-onde
• Réfrigérateur et congélateur
• Éviter l'humidité

LOUIS TELLIER
www.louistellier.fr
Distribué par Louis Tellier

FRANCE 1887
GOBEL
rien ne remplace le fait main

PAPIER J
ORIG
" LA PRA

DÉMOULAGE FACILE ET RAPIDE
• Sans matière grasse, démoulage parfait
• Revêtement antiadhérent **bi-couche**, qualité professionnelle

TRÈS BONNE DIFFUSION DE LA CHALEUR
• Cuisson impeccable et uniforme
• Bonne conduction par son matériau d'acier* revêtu d'antiadhérent

RÉSISTE AUX TEMPÉRATURES ÉLEVÉES
• Température de chauffe allant jusqu'à 250°C
*Matériau en alu revêtu d'antiadhérent possible pour certain moule.

LE CONSEIL DU CHEF
Pour conserver un antiadhérent de qualité, éviter les rayures. Ainsi privilégier une découpe de la préparation en dehors du moule.

ENTRETIEN
• Nettoyer avant la 1^{ère} utilisation
• Ne pas passer au lave-vaisselle
• Laver à l'eau savonneuse

LOUIS TELLIER
www.louistellier.fr
Gobel une marque du Groupe Louis Tellier

L'ANTIADHÉRE
" LA FACILITÉ "



Après nettoyage au lave-vaisselle, éviter les produits abrasifs

LOUIS TELLIER
www.louistellier.fr
Gobel une marque du Groupe Louis Tellier

ESPOSITORES Y SOPORTE DE VENTAS



ESPOSITORES, CABALLETTE, REGARGA RECETAS Y POSTER

298

ESPOSITOR PARA PASTÉIS DE NATA

Se ofrece para configurar 24 moldes para pastéis de nata.

Cartón

GOBEL

Réf.				
307138	26	20	36	196517

ESPOSITOR VACÍO PARA MOLDES ACANALADOS

Se ofrece para montar 24 canelés bordeleses, todos los modelos combinados.

Cartón

GOBEL

Réf.					
307130	26	20	36	0,28	729510 / 729520 / 729530

ESPOSITOR VACÍO PARA INDIVIDUALES MOLDES CAKE

Se ofrece para configurar 24 moldes de pastel individuales.

Cartón

GOBEL

Réf.				
307140	26	20	36	307140

ESPOSITOR VACÍO PARA EMPUJADORES DE MASA

Se ofrece para configurar 12 empujadores de masa.

Madera y cartón

GOBEL

Réf.			
307131	16,5	1	319110

CABALLETTE PORTA-RECETAS BANDEJA BARQUITAS

Póngase en contacto con su representante.

GOBEL

Réf.			
307132	17	17	298410

CABALLETTE PORTA-RECETAS DE PAN CASERO

Póngase en contacto con su representante.

Cartón

GOBEL

Réf.			
307136	17	17	234010 / 223690 / 134000 / 123690

«MINI HAMBURGUESA» CABALLETTE

Póngase en contacto con su representante.

Cartón



GOBEL



Réf.	
307146	40 30

RECARGA DE RECETAS 50 PIEZAS

Papel



GOBEL



Réf.		
305253	Canelés bordelais	307130
305255	Pastéis de nata	307138
305256	Barquitas	307132
305257	Brioche	307139
305258	Mini cakes	307140
305254	Pan casero	307136

CLIP GOBEL DE MERCHANDISING

PP

GOBEL



Réf.	
GL19P010	5,5 3,5 1 0,01

SOPORTE EXPOSITOR PARA MOLDES

Acero inoxidable

GOBEL



Réf.	
813710	22 15,5 6 0,24

POSTER « LA CUISINE »

Rollo de cartón individual

Papel brillante



LOUIS TELLIER

Réf.		
PB1	30 44,5 0,06	S
PB2	63 90,5 0,08	L

Las dimensiones se expresan en cm, el peso en kg.
www.louistellier.fr

Familia	Ref.	Designación			
MAQUINAS DE RACLETTE					
BREZ	BREZ-B-12	Manija - lote de 12	BREZ01 / BREZ01C / BREZ02 / BREZ02C / BREZ03 / BREZ04 / BREZ01BA / BREZ01NX		
	BREZ-RDRG	Resistencia de calentamiento (izquierda y derecha)	BREZ01 / BREZ01C / BREZ02 / BREZ02C / BREZ03 / BREZ04 / BREZ01BA / BREZ01NX		
	BREZ01-S	Soporte queso - inox	BREZ01 / BREZ01C / BREZ02 / BREZ02C / BREZ03 / BREZ04 / BREZ01BA / BREZ01NX		
	5005	Cable de alimentación US / BREZ02 / BREZ02C / RACL02 / RACL02C	BREZ02 / BREZ02C / RACL02 / RACL02C		
	5007	Cable de alimentación 230v	BREZ01C / BREZ01BA / BREZ01NX		
	5010	Cable de alimentación UK / BREZ03 / RACL03	BREZ03		
	5004	Cable de alimentación CH / BREZ04	BREZ04		
	5032	Interruptor - excepto BREZ02 / BREZ02C	BREZ01 / BREZ01C / BREZ01BA / BREZ01NX / BREZ03 / BREZ04		
	BREZ05-P	Mango de madera / BREZ01NX	BREZ01NX		
	CAR01	Cuchillo especial Raclette	BREZ01 / BREZ01C / BREZ02 / BREZ02C / BREZ03 / BREZ04 / BREZ01BA / BREZ01NX		
RACL	5005	Cable de alimentación US / BREZ02 / BREZ02C / RACL02 / RACL02C	BREZ02 / BREZ02C		
	5007	Cable de alimentación 230v	RACPN01X / RACL01 / RACL01BA / RACL01NX		
	5010	Cable de alimentación UK / BREZ03 / RACL03	RACL03		
	5012-5	Botón de maniobra - lote del 5	RACL01 / RACL02 / RACL02C / RACL03 / RACL01BA / RACL01NX		
	5006	Resistencia de calentamiento	RACL01 / RACL02 / RACL02C / RACL03 / RACL01BA / RACL01NX		
	5019	Kit soporte queso + bola negra	RACL01 / RACL02 / RACL02C / RACL03 / RACL01BA / RACL01NX		
	5020-5	Bola negra sola - lote del 5	RACL01 / RACL02 / RACL02C / RACL03 / RACL01BA / RACL01NX		
	5018	Cremallera	RACL01 / RACL02 / RACL02C / RACL03 / RACL01BA / RACL01NX		
	5001-10	Pasador para botón de maniobra - lote del 10	RACL01 / RACL02 / RACL02C / RACL03 / RACL01BA / RACL01NX		
	5027	Mango de madera / RACL01NX	RACL01NX		
	CAR01	Cuchillo especial Raclette	RACL01 / RACL02 / RACL02C / RACL03 / RACL01BA / RACL01NX		
	5021	Corredera izquierda soporte para queso	RACL01 / RACL02 / RACL02C / RACL03 / RACL01BA / RACL01NX		
	5023	Corredera derecha soporte para queso	RACL01 / RACL02 / RACL02C / RACL03 / RACL01BA / RACL01NX		
	RACPN01X	5033	lote de 4 poelones	RACPN01X	
		5007	cable de alimentación	RACPN01X	
5034		Resistencia de calentamiento	RACPN01X		
5035		Placa superior	RACPN01X		
5037		Placa inferior - soporte para poelones	RACPN01X		
MAQUINAS DE RACLETTE TTM					
TTM	BRU01-2	Quemador alcohol - lote de 2	TTM03 / TTM80AL		
	TTM05BC	Calefactor completo 230v / TTM05	TTM05		
	TTM05R	Resistencia 230v / TTM05	TTM05		
	TTM05E	Base para / TTM05 (sin botón)	TTM05 / TTM05C-110		
	TTM05B	Botón de atornillar negro / TTM	TTM05 / TTM10 / TTM20 / TTM05C-110 / TTM10C-110 / TTM20C-110		
	TTM05BA	Brazo articulado / TTM05	TTM05 / TTM05C-110		
	TTM05PF	Porta queso	TTM05 / TTM05C-110		
	TTM05COR	Cable de alimentación 230v / TTM05	TTM05		
	TTM10BC	Calefactor completo 230v / TTM10 / TTM20	TTM10 / TTM20 / TTM30		
	TTM10R	Resistencia 230v / TTM10 / TTM20 / TTM30	TTM10 / TTM20		
	TTM10JNT	Interruptor / TTM10 / TTM20	TTM10 / TTM20 / TTM10C-110 / TTM20C-110		
	TTM10SF	Soporte de queso completo / TTM10 / TTM20	TTM10 / TTM20 / TTM10C-110 / TTM20C-110		
	TTM10P	Mango de goma	TTM10 / TTM20 / TTM10C-110 / TTM20C-110		
	TTM10COR	Cable de alimentación 230v / TTM10	TTM10 / TTM20		
	TTM30SF	Soporte de queso completo / TTM30	TTM30		
	TTM30VIS-MPF	Tornillo montaje porta queso	TTM30		
	TTM30TF	Varilla roscada central / TTM30	TTM30		
	TTM30-BTTF	Botón negro para varilla roscada / TTM30	TTM30		
	TTM30-T	Termostato + botón / TTM30	TTM30		
	TTM40CER	Resistencia 230v / TTM40CE	TTM40CE		
	TTM40CEP	Sartén triangular, mango de madera / TTM40CE	TTM40CE		
	TTM80EB	Base eléctrica 230v / TTM80E	TTM80E		
	TTM80ECH	Sombrero solo / TTM80E	TTM80E		
	TTM80ECP	Sartén, mango de madera / TTM80E	TTM80E		
	TTM80ES	Soporte circular de acero cromado del sombrero / TTM80E	TTM80E		

Familia	Ref.	Designación			
MOLINO DE TOMATE					
CT3X CT3X-EL	CT3-M	Manivela / CT3X		CT3X/CT3X-EL	
	CT3-OPTHV5	Opción picadora rejilla 6 mm / CTX5 / CT3X-EL		CT3X/CT3X-EL	
	CT3-PI-M	Pivote de transmisión / CT3P / CT3X		CT3X	
	CT3-VIS	Eje sin fin de plástico / CT3X / CT3X-EL		CT3X-CT3X-EL	
	CT3X-CME	Tapa + engranajes para motor / CT3X		CT3X	
	CT3X-CORPS	Cuerpo de hierro fundido completo / CT3X / CT3P		CT3X	
	CT3X-E	Embudo inox / CT3X		CT3X	
	CT3X-EG	Escurreidor de acero inoxidable / CT3X		CT3X	
	CT3X-ELPC	Protección contra proyecciones / CT3X-EL		CT3X-EL	
	CT3X-ELCORPS	Cuerpo de hierro fundido / CT3X-EL		CT3X-EL	
	CT3X-ELJ	Junta de embudo / CT3X-EL		CT3X-EL	
	CT3X-F	Filtro inox estándar (Ø 1,5 mm)		CT3X	
	CT3X-FS	Filtro inox especial grosellas (Ø 1 mm)		CT3X	
	CT3X-FSG	Filtro inox (Ø 2,5 mm)		CT3X	
	CT3X-PAT	Patín fijación brida / CT3X		CT3X	
	CT3X-PIE	Pivote de transmisión / CT3X-EL		CT3X-EL	
	BALANZAS ELECTRONICAS				
	N3697	N3697-PLT	Bandeja inox / N3697		N3697
N3697-S		Soporte plástico para bandeja inox / N3697		N3697	
N3697-PP		Protección plástica + panel frontal		N3697	
N3697-CS		Tapa superior		N3697	
N3697-PCB		Tarjeta electrónica + pantalla LCD		N3697	
N3697-CAP		Sensor de peso		N3697	
N3697-J		Junta de estanqueidad / N3697		N3697	
N3697-B		Batería recargable		N3697	
N3697-CP		Tapa de la batería		N3697	
N3697-A		Adaptador de alimentación / N3697		N3697	
N3697-PI4		Lote de 4 pies		N3697	
N3670 N3671 N3672	N3670-PLTX	Bandeja inox / N3670 / N3671 / N3672 / N3673		N3670/N3671/N3672/N3673	
	N3670-P	Bandeja de plástico / N3670 / N3671 / N3672 / N3673		N3670	
	N3670-PP	Panel frontal / N3670		N3670	
	N3671-PP	Panel frontal / N3671		N3671	
	N3672-PP	Panel frontal / N3672		N3672	
	N3673-PP	Panel frontal / N3673		N3673	
	N3671-PK	Panel de control / N3670 / N3671 / N3672 / N3673		N3670/N3671/N3672/N3673	
	N3670-CAP	Sensor de peso / N3670		N3670	
	N3671-CAP	Sensor de peso / N3671		N3671	
	N3672-CAP	Sensor de peso / N3672		N3672	
	N3673-CAP	Sensor de peso / N3673		N3673	
	N3670-PCB	Tarjeta electrónica + pantalla LCD / N3670		N3670	
	N3671-PCB	Tarjeta electrónica + pantalla LCD / N3671		N3671	
	N3672-PCB	Tarjeta electrónica + pantalla LCD / N3672		N3672	
	N3673-PCB	Tarjeta electrónica + pantalla LCD / N3673		N3673	
	N3670-CP	Tapa de la batería / N3670 / N3671 / N3672 / N3673		N3670/N3671/N3672/N3673	
	N3670-PI4	Lote de 4 pies / N3670 / N3671 / N3672 / N3673		N3670/N3671/N3672/N3673	
	N3670-A	Adaptador de alimentación / N3670 / N3671 / N3672 / N3673		N3670/N3671/N3672/N3673	
N3693 N3694	N3694-PLT	Tapa inox superior / N3693 / N3694		N3693/N3694	
	N3694-P	Bandeja de plástico / N3693 / N3694		N3693/N3694	
	N3693-CP	Tapa de la batería / N3693 / N3694		N3693	
	N3693-PP	Panel frontal / N3693		N3693	
	N3694-PP	Panel frontal / N3694		N3694	
	N3693-PI4	Lote de 4 pies / N3693 / N3694		N3693/N3694	
	N3693-CAP	Sensor de peso / N3693		N3693	
	N3694-CAP	Sensor de peso / N3694		N3694	
	N3693-PCB	Tarjeta electrónica + pantalla LCD / N3693		N3693	
	N3694-PCB	Tarjeta electrónica + pantalla LCD / N3694		N3694	
	N3693-A	Adaptador de alimentación / N3693 / N3694		N3693/N3694	

Familia	Ref.	Designación		
N3681 N3682	N3681-PLTX	Bandeja inox / N3681 / N3682		N3681/N3682
	N3681-JS	Junta de silicona - lote de 4 / N3681 / N3682		N3681/N3682
	N3682-PP	Panel frontal / N3682		N3682
	N3681-PP	Panel frontal / N3681		N3681
	N3681-PI4	Lote de 4 pies / N3681 / N3682		N3681/N3682
N3684 N3685 N3686	N3684-BAT	Batería recargable / N3684 / N3685 / N3686		N3684/N3685/N3686
	N3684-FUS	Fusible / N3684 / N3685 / N3686		N3684/N3685/N3686
	N3684-PCB	Tarjeta electrónica (sin pantalla LCD) / N3684		N3684
	N3685-PCB	Tarjeta electrónica (sin pantalla LCD) / N3685		N3685
	N3686-PCB	Tarjeta electrónica (sin pantalla LCD) / N3686		N3686
	N3684-PP	Panel frontal / N3684 / N3685 / N3686		N3684/N3685/N3686
	N3684-PK	Panel de control / N3684 / N3685 / N3686		N3684/N3685/N3686
	N3684-COR	Cable de alimentación 230v / N3684 / N3685 / N3686		N3684/N3685/N3686
	N3685-9	T de conexión / N3684 / N3685 / N3686		N3684/N3685/N3686
	N3684-C	Columna soporte caja / N3684 / N3685		N3684/N3685
	N3685-E	Pantalla LCD / N3684 - N3685 - N3686		N3684/N3685/N3686
	N3684-B	Caja eléctrica completa / N3684		N3684
	N3685-B	Caja eléctrica completa / N3685		N3685
	N3686-B	Caja eléctrica completa / N3686		N3686
	N3686-C	Columna soporte caja / N3686		N3686
	N3684-P	Bandeja inox / N3684 / N3685		N3684/N3685
	N3686-P	Bandeja inox / N3686		N3686
	N3684-CAP	Sensor de peso / N3684		N3684
	N3685-CAP	Sensor de peso / N3685		N3685
	N3686-CAP	Sensor de peso / N3686		N3686
N3684-PI4	Lote de 4 pies / N3684 / N3685 / N3686		N3684/N3685/N3686	

BBQ DE LA MESA

BRAS	GRIL-BRX	Rejilla para brasero		BRAS01 / BRASI-O / BRASI-F
	BRAS01-F	Foco de acero		BRAS01 / BRASI-O / BRASI-F
	BRAS01-PC	Placa cenicero de acero / BRAS01		BRAS01
	BRAS-POI	Mango de transporte / foco del brasero		BRAS01 / BRASI-O / BRASI-F
	CEND-BRX	Cenicero / BRASI-O / BRASI-F		BRASI-O / BRASI-F
	SOLE-BRX	Fondo / BRASI-O / BRASI-F		BRASI-O / BRASI-F

LICUADORA ELECTRICA

CEN426	CEN-BROS	Cepillo / CEN426		CEN426
	CEN-C	Condensador / CEN426		CEN426
	CEN-E	Entrenador / CEN426		CEN426
	CEN-ES	Tuerca especial entrenador / CEN426		CEN426
	CEN-I	Interruptor on-off / CEN426		CEN426
	CEN-R	Disco para el entrenador / CEN426		CEN426
	CEN422B	Recipiente de pulpa / CEN426		CEN426
	CEN422F	Filtro / CEN426		CEN426
	CEN422R	Recipiente de jugo / CEN426		CEN426
	CEN426BM	Motor completo / CEN426 (arco redondo)		CEN426
	CEN426BOL	Recipiente graduado de jugo / CEN426		CEN426
	CEN426C	Tapa / CEN426		CEN426
	CEN426CA	Calota / CEN426		CEN426
	CEN426P	Pulsador / CEN426		CEN426
	CEN426TI	Varilla de fijación de la tapa / CEN426		CEN426

CHOCOLATERA

N4905	N4905-P21PP	Tapa plástico		N4905
	N4905-P28-1	Tapa del grifo / N4905		N4905
	N4905-P22	Batidor / N4905		N4905
	N4905-P22-1	Parte de batidor / N4905		N4905
	N4905-P23	Arbol de la cuba / N4905		N4905
	N4905-JA	Junta tórica para árbol de la cuba / N4905		N4905
	N4905-P25	Fondo de cuba inox / N4905		N4905
	N4905-P26	Tuerca del árbol de cuba / N4905		N4905
	N4905-JC	Junta de la cuba / N4905		N4905
	N4905-P	Pistón del grifo / N4905		N4905

Familia	Ref.	Designación		
N4905	N4905-JR	Junta para el pistón del grifo / N4905		N4905
	N4905-L	Palanca del grifo / N4905		N4905
	N4905-R	Muelle del grifo / N4905		N4905
	N4905-GR	Pasador del palanca del grifo / N4905		N4905
	N4905-P33	Cuba plástica / N4905		N4905
	N4905-TC	Junta tórica de la cuba / N4905		N4905
	N4905-P18	Cubeta recogergotas / N4905		N4905
	N4905-P17	Rejilla para cubeta recogergotas / N4905		N4905
	N4905-C	Cuba de plástico con grifo completo / N4905		N4905
	N4905-P1	Boquilla de entrenamiento / N4905		N4905
	N4905-P39	Tubo teflon / N4905		N4905
	N4905-P38	Arbol central / N4905		N4905
	N4905-P2	Cárter de bandeja de calentamiento / N4905		N4905
	N4905-P4	Termocontacto / N4905		N4905
	N4905-P5	Muelle / N4905		N4905
	N4905-P6	Bandeja de calentamiento / N4905		N4905
	N4905-P7	Limitador / N4905		N4905
	N4905-P36	Cojinete / N4905		N4905
	N4905-M	Motor 230v 50hz / N4905		N4905
	N4905-P10	Cuerpo / N4905		N4905
	N4905-P12	Interruptor / N4905		N4905
	N4905-P40	Botón del termostato lateral / N4905		N4905
	N4905-P13	Termostato O° - 90° C		N4905
	N4905-TH2	Termostato O° - 120° C		N4905
	N4905-P15	Base		N4905
	N4905-P16	Pie de goma		N4905
	N4905-P41	Botón del termostato		N4905
	N4905-P20	Caja de conexión		N4905
N4905-P19	Paso cable de alimentación / N4905		N4905	
N4905-P21SS	Tapa de acero inox		N4905	

CORTADOR EN BASTONCILLOS

CC08 CC10	CF308	Cuchilla de acero inoxidable 8 x 8 mm	CC08 / CC10
	CF310	Cuchilla de acero inoxidable 10 x 10 mm	CC08 / CC10
	CC208.	Empujador 8 x 8 mm / CC	CC08 / CC10
	CC210.	Empujador 10 x 10 mm / CC	CC08 / CC10
	CAX020	juego de 3 pies altos	CC08 / CC10
	GX016-12	Ventosa y anillo - lote de 12	CC08 / CC10
	CAX023-10CC	Muelles de columna CC - lote del 10	CC08 / CC10
	CCGP5	Pasador del empujador - lote de 5	CC08 / CC10
	CF0005X-2	Muelle inox con moleta - lote de 3	CC08 / CC10
	CF0006	Biela (sin atornillar)	CC08 / CC10

CORTADOR DE 1/2 O 1/4 DE RODAJAS DE LIMON

CDX	CAX017	Platina plástica superior con asas	CDX4 / CDX7 / CDX40 / CDX70 / CDX47
	CAX018	Platina plástica inferior sin asas	CDX4 / CDX7 / CDX40 / CDX70 / CDX47
	GX016-12	Ventosa y anillo - lote de 12	CDX4 / CDX7 / CDX40 / CDX70 / CDX47
	CAX019	Juego de 2 columnas de acero inoxidable	CDX4 / CDX7 / CDX40 / CDX70 / CDX47
	CAX021	Pie corto (3 uds.)	CDX4 / CDX7 / CDX40 / CDX70 / CDX47
	CDX004	Bloque de corte solo 12 mm	CDX4 / CDX7 / CDX40 / CDX70 / CDX47
	CDX007	Bloque de corte solo 6 mm	CDX4 / CDX7 / CDX40 / CDX70 / CDX47
	CDX40	Bloque de corte completo hoja 12 mm / CDX	CDX4 / CDX7 / CDX40 / CDX70 / CDX47
	CDX70	Bloque de corte completo hoja 6 mm / CDX	CDX4 / CDX7 / CDX40 / CDX70 / CDX47

DISPENSADOR PARA FILM TRANSPARENTE Y ALUMINIO

DFV300 DFV450	GX016-12	Ventosa y anillo - lote de 12	DFV300 / DFV450
	GX017-4	Pie de acero inox corto - lote de 4	DFV300 / DFV451
	DF030	Regleta de corte 30 cm / DFV300	DFV300
	DF045	Regleta de corte 45 cm / DFV450	DFV450
	DF300T	Varilla central / DFV300	DFV300
	DF450T	Varilla central / DFV450	DFV450

Familia	Ref.	Designación			
CORTA PATATAS PROFESSIONAL					
CX	CF306	Cuchilla de acero inoxidable 6 x 6 mm	CX00 / CX06 / CX08 / CX10 / CX13		
	CF308	Cuchilla de acero inoxidable 8 x 8 mm	CX00 / CX06 / CX08 / CX10 / CX13		
	CF310	Cuchilla de acero inoxidable 10 x 10 mm	CX00 / CX06 / CX08 / CX10 / CX13		
	CF313	Cuchilla de acero inoxidable 13 x 13 mm	CX00 / CX06 / CX08 / CX10 / CX13		
	CF206	Empujador 6 x 6 mm para corta patatas	CX00 / CX06 / CX08 / CX10 / CX13		
	CF208	Empujador 8 x 8 mm para corta patatas	CX00 / CX06 / CX08 / CX10 / CX13		
	CF210	Empujador 10 x 10 mm / 10 x 20 mm / 20 x 20 mm para corta patatas	CX00 / CX06 / CX08 / CX10 / CX13		
	CF213	Empujador 13 x 13 mm para corta patatas	CX00 / CX06 / CX08 / CX10 / CX13		
	C006X	Kit cuchilla inox + empujador 6 x 6 mm para corta patatas inox	CX00 / CX06 / CX08 / CX10 / CX13		
	C008X	Kit cuchilla inox + empujador 8 x 8 mm para corta patatas inox	CX00 / CX06 / CX08 / CX10 / CX13		
	C010X	Kit cuchilla inox + empujador 10 x 10 mm para corta patatas inox	CX00 / CX06 / CX08 / CX10 / CX13		
	C013X	Kit cuchilla inox + empujador 13 x 13 mm para corta patatas inox	CX00 / CX06 / CX08 / CX10 / CX13		
	CF0005X-2	Muelle inox con moleta - lote de 3	CX00 / CX06 / CX08 / CX10 / CX13		
	CF0007	Corredera para corta patatas profesional	CX00 / CX06 / CX08 / CX10 / CX13		
	CF0018-3	Pie para base - lote de 9	CX00 / CX06 / CX08 / CX10 / CX13		
	CX020	Base inox - sin pie	CX00 / CX06 / CX08 / CX10 / CX13		
	CF0003	Bola para mango	CX00 / CX06 / CX08 / CX10 / CX13		
	CF0004	Canalón porta cuchilla + muelle con moleta	CX00 / CX06 / CX08 / CX10 / CX13		
	CF0006	Biela (sin atornillar)	CX00 / CX06 / CX08 / CX10 / CX13		
	CX-P	CF306	Cuchilla de acero inoxidable 6 x 6 mm	CX00-P / CX06-P / CX08-P / CX10-P / CX13-P	
		CF308	Cuchilla de acero inoxidable 8 x 8 mm	CX00-P / CX06-P / CX08-P / CX10-P / CX13-P	
		CF310	Cuchilla de acero inoxidable 10 x 10 mm	CX00-P / CX06-P / CX08-P / CX10-P / CX13-P	
		CF313	Cuchilla de acero inoxidable 13 x 13 mm	CX00-P / CX06-P / CX08-P / CX10-P / CX13-P	
		CF206	Empujador 6 x 6 mm para corta patatas	CX00-P / CX06-P / CX08-P / CX10-P / CX13-P	
		CF208	Empujador 8 x 8 mm para corta patatas	CX00-P / CX06-P / CX08-P / CX10-P / CX13-P	
		CF210	Empujador 10 x 10 mm / 10 x 20 mm / 20 x 20 mm para corta patatas	CX00-P / CX06-P / CX08-P / CX10-P / CX13-P	
		CF213	Empujador 13 x 13 mm para corta patatas	CX00-P / CX06-P / CX08-P / CX10-P / CX13-P	
C006X		Kit cuchilla inox + empujador 6 x 6 mm para corta patatas inox	CX00-P / CX06-P / CX08-P / CX10-P / CX13-P		
C008X		Kit cuchilla inox + empujador 8 x 8 mm para corta patatas inox	CX00-P / CX06-P / CX08-P / CX10-P / CX13-P		
C010X		Kit cuchilla inox + empujador 10 x 10 mm para corta patatas inox	CX00-P / CX06-P / CX08-P / CX10-P / CX13-P		
C013X		Kit cuchilla inox + empujador 13 x 13 mm para corta patatas inox	CX00-P / CX06-P / CX08-P / CX10-P / CX13-P		
CF0005X-2		Muelle inox con moleta - lote de 3	CX00-P / CX06-P / CX08-P / CX10-P / CX13-P		
CF0007		Corredera para corta patatas profesional	CX00-P / CX06-P / CX08-P / CX10-P / CX13-P		
GX017-4		Pie de acero inox corto - lote de 4	CX00-P / CX06-P / CX08-P / CX10-P / CX13-P		
GX016-12		Ventosa y anillo - lote de 12	CX00-P / CX06-P / CX08-P / CX10-P / CX13-P		
CF0006		Biela (sin atornillar)	CX00-P / CX06-P / CX08-P / CX10-P / CX13-P		
CF0004		Canalón porta cuchilla + muelle con moleta	CX00-P / CX06-P / CX08-P / CX10-P / CX13-P		
CF0003		bola para mango	CX00-P / CX06-P / CX08-P / CX10-P / CX13-P		
CS		CF106	Cuchilla estañada 6 x 6 mm para corta patatas	CS00 / CS06 / CS08 / CS10 / CS13	
		CF108	Cuchilla estañada 8 x 8 mm para corta patatas	CS00 / CS06 / CS08 / CS10 / CS13	
		CF110	Cuchilla estañada 10 x 10 mm para corta patatas	CS00 / CS06 / CS08 / CS10 / CS13	
		CF113	Cuchilla estañada 13 x 13 mm para corta patatas	CS00 / CS06 / CS08 / CS10 / CS13	
		CF120	Cuchilla estañada de 10 x 20 mm para corta patatas	CS00 / CS06 / CS08 / CS10 / CS13	
		CF122	Cuchilla estañada de 20 x 20 mm para corta patatas	CS00 / CS06 / CS08 / CS10 / CS13	
		CF1K	Cuchilla estañada 6 secciones para corta patatas	CS00 / CS06 / CS08 / CS10 / CS13	
		CF206	Empujador 6 x 6 mm para corta patatas	CS00 / CS06 / CS08 / CS10 / CS13	
	CF208	Empujador 8 x 8 mm para corta patatas	CS00 / CS06 / CS08 / CS10 / CS13		
	CF210	Empujador 10 x 10 mm / 10 x 20 mm / 20 x 20 mm para corta patatas	CS00 / CS06 / CS08 / CS10 / CS13		
	CF213	Empujador 13 x 13 mm para corta patatas	CS00 / CS06 / CS08 / CS10 / CS13		
	CF2K	Empujador 6 secciones para corta patatas	CS00 / CS06 / CS08 / CS10 / CS13		
	C006	Kit cuchilla estañada - empujador 6 x 6 mm	CS00 / CS06 / CS08 / CS10 / CS13		
	C008	Kit cuchilla estañada - empujador 8 x 8 mm	CS00 / CS06 / CS08 / CS10 / CS13		
	C010	Kit cuchilla estañada - empujador 10 x 10 mm	CS00 / CS06 / CS08 / CS10 / CS13		
	C013	Kit cuchilla estañada - empujador 13 x 13 mm	CS00 / CS06 / CS08 / CS10 / CS13		
	C020	Kit cuchilla estañada - empujador 10 x 20 mm	CS00 / CS06 / CS08 / CS10 / CS13		
	C022	Kit cuchilla estañada - empujador 20 x 20 mm	CS00 / CS06 / CS08 / CS10 / CS13		
	C00K	Kit cuchilla estañada - empujador 6 secciones	CS00 / CS06 / CS08 / CS10 / CS13		
	CF0005-2	Muelle con moleta - lote de 2	CS00 / CS06 / CS08 / CS10 / CS13		
	CF0007	Corredera para corta patatas profesional	CS00 / CS06 / CS08 / CS10 / CS13		
	CF0018-3	Pie para base - lote de 9	CS00 / CS06 / CS08 / CS10 / CS13		
	CF0009	Base pesada epoxy (sin pie)	CS00 / CS06 / CS08 / CS10 / CS13		
	CF0008	Base pesada epoxy (sin pie) - export	CS00 / CS06 / CS08 / CS10 / CS13		

Familia	Ref.	Designación		
CS	CF0004	Canalón porta cuchilla + muelle con moleta	CS00 / CS06 / CS08 / CS10 / CS13	
	CF0006	Biela (sin atornillar)	CS00 / CS06 / CS08 / CS10 / CS13	
	CF0003	Bola para mango	CS00 / CS06 / CS08 / CS10 / CS13	
	CF0016	Kit tornillo fijación base	CS00 / CS06 / CS08 / CS10 / CS13	
CP	CF106	Cuchilla estañada 6 x 6 mm para corta patatas	CP00 / CP06 / CP08 / CP10 / CP13	
	CF108	Cuchilla estañada 8 x 8 mm para corta patatas	CP00 / CP06 / CP08 / CP10 / CP13	
	CF110	Cuchilla estañada 10 x 10 mm para corta patatas	CP00 / CP06 / CP08 / CP10 / CP13	
	CF113	Cuchilla estañada 13 x 13 mm para corta patatas	CP00 / CP06 / CP08 / CP10 / CP13	
	CF120	Cuchilla estañada de 10 x 20 mm para corta patatas	CP00 / CP06 / CP08 / CP10 / CP13	
	CF122	Cuchilla estañada de 20 x 20 mm para corta patatas	CP00 / CP06 / CP08 / CP10 / CP13	
	CF1K	Cuchilla estañada 6 secciones para corta patatas	CP00 / CP06 / CP08 / CP10 / CP13	
	CF206	Empujador 6 x 6 mm para corta patatas	CP00 / CP06 / CP08 / CP10 / CP13	
	CF208	Empujador 8 x 8 mm para corta patatas	CP00 / CP06 / CP08 / CP10 / CP13	
	CF210	Empujador 10 x 10 mm / 10 x 20 mm / 20 x 20 mm para corta patatas	CP00 / CP06 / CP08 / CP10 / CP13	
	CF213	Empujador 13 x 13 mm para corta patatas	CP00 / CP06 / CP08 / CP10 / CP13	
	CF2K	Empujador 6 secciones para corta patatas	CP00 / CP06 / CP08 / CP10 / CP13	
	C006	Kit cuchilla estañada - empujador 6 x 6 mm	CP00 / CP06 / CP08 / CP10 / CP13	
	C008	Kit cuchilla estañada - empujador 8 x 8 mm	CP00 / CP06 / CP08 / CP10 / CP13	
	C010	Kit cuchilla estañada - empujador 10 x 10 mm	CP00 / CP06 / CP08 / CP10 / CP13	
	C013	Kit cuchilla estañada - empujador 13 x 13 mm	CP00 / CP06 / CP08 / CP10 / CP13	
	C020	Kit cuchilla estañada - empujador 10 x 20 mm	CP00 / CP06 / CP08 / CP10 / CP13	
	C022	Kit cuchilla estañada - empujador 20 x 20 mm	CP00 / CP06 / CP08 / CP10 / CP13	
	C00K	Kit cuchilla estañada - empujador 6 secciones	CP00 / CP06 / CP08 / CP10 / CP13	
	CF0005-2	Muelle con moleta - lote de 2	CP00 / CP06 / CP08 / CP10 / CP13	
CF0007	Corredera para corta patats profesional	CP00 / CP06 / CP08 / CP10 / CP13		
CF0010	Pie tubo	CP00 / CP06 / CP08 / CP10 / CP13		
C00	CF0004	Canalón porta cuchilla + muelle con moleta	CP00 / CP06 / CP08 / CP10 / CP13	
	CF0006	Biela (sin atornillar)	CP00 / CP06 / CP08 / CP10 / CP13	
	CF0003	Bola para mango	CP00 / CP06 / CP08 / CP10 / CP13	
	CF106	Cuchilla estañada 6 x 6 mm para corta patatas	C00 / C06 / C08 / C10 / C13	
	CF108	Cuchilla estañada 8 x 8 mm para corta patatas	C00 / C06 / C08 / C10 / C13	
	CF110	Cuchilla estañada 10 x 10 mm para corta patatas	C00 / C06 / C08 / C10 / C13	
	CF113	Cuchilla estañada 13 x 13 mm para corta patatas	C00 / C06 / C08 / C10 / C13	
	CF120	Cuchilla estañada de 10 x 20 mm para corta patatas	C00 / C06 / C08 / C10 / C13	
	CF122	Cuchilla estañada de 20 x 20 mm para corta patatas	C00 / C06 / C08 / C10 / C13	
	CF1K	Cuchilla estañada 6 secciones para corta patatas	C00 / C06 / C08 / C10 / C13	
	CF206	Empujador 6 x 6 mm para corta patatas	C00 / C06 / C08 / C10 / C13	
	CF208	Empujador 8 x 8 mm para corta patatas	C00 / C06 / C08 / C10 / C13	
	CF210	Empujador 10 x 10 mm / 10 x 20 mm / 20 x 20 mm para corta patatas	C00 / C06 / C08 / C10 / C13	
	CF213	Empujador 13 x 13 mm para corta patatas	C00 / C06 / C08 / C10 / C13	
	CF2K	Empujador 6 secciones para corta patatas	C00 / C06 / C08 / C10 / C13	
	C006	Kit cuchilla estañada - empujador 6 x 6 mm	C00 / C06 / C08 / C10 / C13	
	C008	Kit cuchilla estañada - empujador 8 x 8 mm	C00 / C06 / C08 / C10 / C13	
	C010	Kit cuchilla estañada - empujador 10 x 10 mm	C00 / C06 / C08 / C10 / C13	
	C013	Kit cuchilla estañada - empujador 13 x 13 mm	C00 / C06 / C08 / C10 / C13	
	C020	Kit cuchilla estañada - empujador 10 x 20 mm	C00 / C06 / C08 / C10 / C13	
C022	Kit cuchilla estañada - empujador 20 x 20 mm	C00 / C06 / C08 / C10 / C13		
C00K	Kit cuchilla estañada - empujador 6 secciones	C00 / C06 / C08 / C10 / C13		
CF0005-2	Muelle con moleta - lote de 2	C00 / C06 / C08 / C10 / C13		
CF0007	Corredera para corta patats profesional	C00 / C06 / C08 / C10 / C13		
CM	CF0004	Canalón porta cuchilla + muelle con moleta	C00 / C06 / C08 / C10 / C13	
	CF0006	Biela (sin atornillar)	C00 / C06 / C08 / C10 / C13	
	CF0003	Bola para mango	C00 / C06 / C08 / C10 / C13	
	CF106	Cuchilla estañada 6 x 6 mm para corta patatas	CM00 / CM06 / CM08 / CM10 / CM13	
	CF108	Cuchilla estañada 8 x 8 mm para corta patatas	CM00 / CM06 / CM08 / CM10 / CM13	
	CF110	Cuchilla estañada 10 x 10 mm para corta patatas	CM00 / CM06 / CM08 / CM10 / CM13	
	CF113	Cuchilla estañada 13 x 13 mm para corta patatas	CM00 / CM06 / CM08 / CM10 / CM13	
	CF120	Cuchilla estañada de 10 x 20 mm para corta patatas	CM00 / CM06 / CM08 / CM10 / CM13	
	CF122	Cuchilla estañada de 20 x 20 mm para corta patatas	CM00 / CM06 / CM08 / CM10 / CM13	
	CF1K	Cuchilla estañada 6 secciones para corta patatas	CM00 / CM06 / CM08 / CM10 / CM13	
	CF206	Empujador 6 x 6 mm para corta patatas	CM00 / CM06 / CM08 / CM10 / CM13	
	CF208	Empujador 8 x 8 mm para corta patatas	CM00 / CM06 / CM08 / CM10 / CM13	
	CF210	Empujador 10 x 10 mm / 10 x 20 mm / 20 x 20 mm para corta patatas	CM00 / CM06 / CM08 / CM10 / CM13	
	CF213	Empujador 13 x 13 mm para corta patatas	CM00 / CM06 / CM08 / CM10 / CM13	

Familia	Ref.	Designación			
CM	CF2K	Empujador 6 secciones para corta patatas	CM00 / CM06 / CM08 / CM10 / CM13		
	C006	Kit cuchilla estañada - empujador 6 x 6 mm	CM00 / CM06 / CM08 / CM10 / CM13		
	C008	Kit cuchilla estañada - empujador 8 x 8 mm	CM00 / CM06 / CM08 / CM10 / CM13		
	C010	Kit cuchilla estañada - empujador 10 x 10 mm	CM00 / CM06 / CM08 / CM10 / CM13		
	C013	Kit cuchilla estañada - empujador 13 x 13 mm	CM00 / CM06 / CM08 / CM10 / CM13		
	C020	Kit cuchilla estañada - empujador 10 x 20 mm	CM00 / CM06 / CM08 / CM10 / CM13		
	C022	Kit cuchilla estañada - empujador 20 x 20 mm	CM00 / CM06 / CM08 / CM10 / CM13		
	C00K	Kit cuchilla estañada - empujador 6 secciones	CM00 / CM06 / CM08 / CM10 / CM13		
	CF0005-2	Muelle con moleta - lote de 2	CM00 / CM06 / CM08 / CM10 / CM13		
	CF0007	Corredera para corta patatas profesional	CM00 / CM06 / CM08 / CM10 / CM13		
	CF0011	Fijación mural	CM00 / CM06 / CM08 / CM10 / CM13		
	CF0004	Canalón porta cuchilla + muelle con moleta	CM00 / CM06 / CM08 / CM10 / CM13		
	CF0006	Biela (sin atornillar)	CM00 / CM06 / CM08 / CM10 / CM13		
	CF0003	Bola para mango	CM00 / CM06 / CM08 / CM10 / CM13		
	CSP10	VLT12	Pie ventosa x12	CSP10	
		LT20A009	Kit cuchilla + empujador 10 x 10 mm	CSP10	
		LT20A010	Corredera de plástico	CSP10	
LT20S001		Porta cuchilla + 2 tornillos de fijación	CSP10		
CFPN	CF310	Cuchilla de acero inoxidable 10 x 10 mm	CFPN10/CFPN08		
	CF308	Cuchilla de acero inoxidable 8 x 8 mm	CFPN10/CFPN08		
	CC210.	Empujador 10 x 10 mm / CC	CFPN10/CFPN08		
	CC208.	Empujador 8 x 8 mm / CC	CFPN10/CFPN08		

CORTADOR EN TIRAS

CLAN	4051-1	Manivela (eje redondo)	CLANX / CLANX-05	
	8010	Eje de arrastre con aletas	CLANX / CLANX-05	
	8005	Eje de arrastre largo con aletas - legumbres blandas	CLANX / CLANX-05	
	8001	Caja de corte 1mm (fino)	CLANX / CLANX-05	
	8002	Caja de corte 1,5mm (estandar)	CLANX / CLANX-05	
	8003	Caja de corte 2,3mm (grueso)	CLANX / CLANX-05	
	VLT12	Pie ventosa x12	CLANX / CLANX-05	
	8009	Tubo de centrado	CLANX / CLANX-05	
	8006	Cuchilla corta 1 mm	CLANX / CLANX-05	
	8007	Cuchilla corta 1,5 mm	CLANX / CLANX-05	
	8008	Cuchilla corta 2,3 mm	CLANX / CLANX-05	

CORTADOR DE VERDURAS JAPONES

CLAN	CLAN03-LAP	Hoja plana / CLAN03	CLAN03	
	CLAN-GRV	Garra de enganche verde / CLAN01 / CLAN02 / CLAN03	CLAN01 / CLAN02 / CLAN03	
	CLAN-M	Manivela para CLAN01 / CLAN02 / CLAN03	CLAN01 / CLAN02 / CLAN03	
	CLAN-AXE	Eje + 2 garras de enganche + boquilla / CLAN01 / CLAN02	CLAN01 / CLAN02	
	CLAN-B	Botón de bloqueo / CLAN01 / CLAN02 / CLAN03	CLAN01 / CLAN02 / CLAN03	
	CLAN-BAN	Caja de corte en tiras + hoja / CLAN01 / CLAN02	CLAN01 / CLAN02	
	CLAN-BE	Anillo de entrenamiento bloque de corte / CLAN01 / CLAN02	CLAN01 / CLAN02	
	CLAN-FI	Bloque de cortar "red" / CLAN01 / CLAN02	CLAN01 / CLAN02	
	CLAN-LAP	Hoja plana / CLAN01 / CLAN02 / CLAN04 + 2 tornillos	CLAN01 / CLAN02 / CLAN04	
	CLAN-MAN	Eje de entrenamiento / CLAN01	CLAN01	
	CLAN-SPA	Bloque de cortar espagueti / CLAN01 / CLAN02	CLAN01 / CLAN02	
	CLAN-SUP	Soporte de hoja / CLAN01 / CLAN02	CLAN01 / CLAN02	
	CLAN-VIS	2 tornillos para hoja plana / CLAN01 / CLAN02 / CLAN03 / CLAN04	CLAN01 / CLAN02 / CLAN03 / CLAN04	
	CLAN01-E19A	Tuerca de eje (junto manivela) - plástico verde / CLAN01	CLAN01	
	CLAN01-E19B	Tuerca de eje (opuesta manivela) - plástico verde / CLAN01	CLAN01	
	CLAN01-FLG	Carcasa izquierda (opuesta manivela) / CLAN01	CLAN01	
	CLAN01-TI	Varilla + tornillo / CLAN01	CLAN01	
	CLAN01-TM	Cabeza del eje de entrenamiento / CLAN01	CLAN01	
	CLAN01-V18A	Tornillo de eje (junto manivela) - plástico verde / CLAN01	CLAN01	
	CLAN01-V18B	Tornillo de eje (opuesta manivela) - plástico verde / CLAN01	CLAN01	
	CLAN02-AXE	Eje centrado / CLAN02 / antiguo modelo	CLAN02	
	CLAN02-B	Pin / CLAN01 / CLAN02	CLAN02	
	CLAN02-BAR	Barra de sujeción / CLAN02	CLAN02	
	CLAN02-E13A	Tuerca de eje (junto manivela) - plástico marrón / CLAN02	CLAN02	
	CLAN02-E13B	Tuerca de eje (opuesta manivela) - plástico marrón / CLAN02	CLAN02	
	CLAN02-ENG	2 engranajes grande y pequeño + clip / CLAN01 / CLAN02	CLAN02	
	CLAN02-G	Garra de entrenamiento marrón (antiguo modelo) / CLAN02	CLAN02	

Familia	Ref.	Designación		
CLAN	CLAN02-V12A	Tornillo de eje (junto manivela) - plástico marrón / CLAN02		CLAN02
	CLAN02-V12B	Tornillo de eje (opuesta manivela) - plástico marrón / CLAN02		CLAN02
	CLAN03-AXE	Eje de entrenamiento completo / CLAN03		CLAN03
	CLAN03-SPA	Bloque de cortar espagueti / CLAN03		CLAN03

CORTADOR DE VERDURAS

N2994 N2997	N2994-13.6	Cuchilla + pulsador 13,6 mm / N2994		N2994
	N2994-6.8	Cuchilla + pulsador 6,8 mm / N2994		N2994
	N2994T6.8	Cuchilla de corte 6,8 mm / N2994		N2994
	N2997-06	Cuchilla + pulsador 6 mm / N2997		N2997
	N2997-06L	Cuchilla de corte 6 mm / N2997		N2997
	N2997-06-P	Peine de limpieza 6 mm / N2996 - N2997		N2997
	N2997-09	Cuchilla + pulsador 9 mm / N2997		N2997
	N2997-09-P	Peine de limpieza 9 mm / N2997		N2997
	N2997-B	Recipiente / N2996 / N2997		N2997
N3011	N3011MX-N	Rejilla de limpieza / N3011MX		N3011MX
	N3011X-03-N	Rejilla de limpieza - plástico negro 3 mm / N3011X		N3011X
	N3011X-03-P	Empujador para rejilla 3 mm / N3011X		N3011X
	N3011X-06-N	Rejilla de limpieza - plástico negro 6 mm / N3011X		N3011X
	N3011X-09-N	Rejilla de limpieza - plástico negro 9 mm / N3011X		N3011X

CORTADOR DE VERDURAS ROUET JAPONES

4500CLR 3000CLR	4500CLR-L	Hoja plana / 4500CLR		4500CLR
	4500CLR-LF	Peine de cortar fino 1 mm / 4500CLR / 3000CLR		4500CLR / 3000CLR
	4500CLR-LL	Peine de cortar largo 4 mm / 4500CLR / 3000CLR		4500CLR / 3000CLR
	4500CLR-C	Bloque de cortar (sin hoja) / 4500CLR		4500CLR
	4500CLR-CE	Carro + escuadra / 4500CLR		4500CLR
	4500CLR-E	Escuadra / 4500CLR		4500CLR
	4500CLR-LM	Peine de cortar medio 2 mm / 4500CLR / 3000CLR		4500CLR / 3000CLR
	4500CLR-RP	Rueda con pinchos / 4500CLR		4500CLR

SECCIONADOR DE MELON

SM01	SM006	Cuchilla inox 6 secciones		SM01 / SM06 / SM08
SM06	SM008	Cuchilla inox 8 secciones		SM01 / SM06 / SM08
SM08	SM007	Soporte completo		SM01 / SM06 / SM08

CORTADOR DE PAN

703S	GX017-4	Pie de acero inox corto - lote de 4		703SF1 / 703SF1P / 703SX
	GX016-12	Ventosa y anillo - lote de 12		703SF1 / 703SF1P / 703SX
	753CP	Protección plástica + tornillo		703SF1 / 703SF1P / 703SX
	723CP	Tornillo de reglado espesor de corte		703SF1 / 703SF1P / 703SX
	716CP	Cuchilla redonda con mango de madera		703SF1
	717CP	Cuchilla redonda con mango de plástico		703SF1P / 703SX
	734CP	Tope de ajuste espesor de corte		703SF1 / 703SF1P / 703SX
	720CP	Mango de madera		703SF1
	733CP	Eje completo		703SF1 / 703SF1P / 703SX
	35CPX	190CL-20	Pie antideslizante / tope - lote de 20	
35CPX-NP		Protección plástica		35CPX
35CPX-NL		Cuchilla + mango		35CPX

CORTADOR DE ENSALADA

CSA CSAL CSAM	CSA01	Juego de cuchillas montadas 23 x 23 mm / CSA		CSA / CSAL
	CSA02	Empujador 23 x 23 mm / CSA		CSA
	CSAL01	Juego de cuchillas montadas tiras 12 x 100 mm / CSAL		CSAL
	CSAL02	Empujador 12 x 100 mm / CSAL		CSA / CSAL
	CSA05	Tuerca moleteada - lote de 2		CSA / CSAL
	EA-GP-5	Pasador del pulsador - lote de 5		CSA / CSAL / CSAM
	GX017-4	Pie de acero inox corto - lote de 4		CSA / CSAL
	GX016-12	Ventosa y anillo - lote de 12		CSA / CSAL / CSAM
	CSAM01	Cuchilla 25 x 25 mm / CSAM		CSAM
	CSAM02	Empujador 25 x 25 mm / CSAM		CSAM
	CSAM04	Tuerca moleteada - lote de 2		CSAM
	OE29046	Mango para palanca		CSA / CSAL

Familia	Ref.	Designación		
CORTADOR DE PATES				
CTER	GX017-4	Pie de acero inox corto - lote de 4	CTER01 / CTER02	
	GX016-12	Ventosa y anillo - lote de 12	CTER01 / CTER02	
	CTER01F	Juego de 2 hilos acero inox (3,1 m) / CTER01	CTER01	
	CTER02F	Juego de 2 hilos acero inox (4,2 m) / CTER02	CTER02	
	4062	Soporte plano 10 mm / CTER	CTER01 / CTER02	
	4063	Soporte plano 7 mm / CTER	CTER01 / CTER02	
	4064	Marco de corte 7 mm / CTER	CTER01 / CTER02	
	4065	Marco de corte 10 mm / CTER	CTER01 / CTER02	
	4066-2	Empuñadura negra - lote de 2	CTER01 / CTER02	
	4061	Muelles inox - lote de 2 / CTER	CTER01 / CTER02	
	4070	Anilla de guía - lote de 4	CTER01 / CTER02	
CORTADOR DE TOMATES/ MANZANAS / AGRIOS				
CAX 104 CAX106 CAX108 CAX112 CAX104P CAX106P CAX108P	CAX004	Cuchilla inox 4 secciones	CAX104 / CAX104P	
	CAX006	Cuchilla inox 6 secciones	CAX106 / CAX106P	
	CAX008	Cuchilla inox 8 secciones	CAX108 / CAX108P	
	CAX012	Cuchilla inox 12 secciones	CAX112 / CAX212	
	CAX004P	Cuchilla inox descorazonadora 4 secciones (manzana)	CAX104 / CAX104P	
	CAX006P	Cuchilla inox descorazonadora 6 secciones (manzana)	CAX106 / CAX106P	
	CAX008P	Cuchilla inox descorazonadora 8 secciones (manzana)	CAX108 / CAX108P	
	CAX015	Empujador/soporte 4 - 8 secciones	CAX104 / CAX104P / CAX108P / CAX108	
	CAX016	Empujador/soporte 6 - 12 secciones	CAX106 / CAX106P / CAX112	
	CAX017	Platina plástica superior con asas	CAX104 / CAX106 / CAX108 / CAX112 / CAX104P / CAX106P / CAX108P	
	CAX018	Platina plástica inferior sin asas	CAX104 / CAX106 / CAX108 / CAX112 / CAX104P / CAX106P / CAX108P	
	GX016-12	Ventosa y anillo - lote de 12	CAX104 / CAX106 / CAX108 / CAX112 / CAX104P / CAX106P / CAX108P	
	CAX019	Juego de 2 columnas de acero inoxidable	CAX104 / CAX106 / CAX108 / CAX112 / CAX104P / CAX106P / CAX108P	
	CAX023-10	Muelles de columna CAX - lote del 10	CAX104 / CAX106 / CAX108 / CAX112 / CAX104P / CAX106P / CAX108P	
	CAX020	Juego de 3 pies altos	CAX104 / CAX108 / CAX112 / CAX104P / CAX106P / CAX108P	
	CAX025-5	Adorno - lote de 5	CAX104 / CAX106 / CAX108 / CAX112 / CAX104P / CAX106P / CAX108P	
	CAX024-20	Estribo de bloqueo del empujador - lote de 20	CAX104 / CAX106 / CAX108 / CAX112 / CAX104P / CAX106P / CAX108P	
	CAX022	Tornillería completa / CAX	CAX104 / CAX106 / CAX108 / CAX112 / CAX104P / CAX106P / CAX108P	
	CAX204 CAX206 CAX208 CAX212	CAX004	Cuchilla inox 4 secciones	CAX204
		CAX006	Cuchilla inox 6 secciones	CAX106 / CAX106P
CAX008		Cuchilla inox 8 secciones	CAX108 / CAX108P	
CAX012		Cuchilla inox 12 secciones	CAX212	
CAX015		Empujador/soporte 4 - 8 secciones	CAX204 / CAX208	
CAX016		Empujador/soporte 6 - 12 secciones	CAX206 / CAX212	
CAX025-5		Adorno - lote de 5	CAX204 / CAX206 / CAX208 / CAX212	
CAX017		Platina plástica superior con asas	CAX204 / CAX206 / CAX208 / CAX212	
CAX018		Platina plástica inferior sin asas	CAX204 / CAX206 / CAX208 / CAX212	
GX016-12		Ventosa y anillo - lote de 12	CAX204 / CAX206 / CAX208 / CAX212	
CAX019		Juego de 2 columnas de acero inoxidable	CAX204 / CAX206 / CAX208 / CAX212	
CAX021		Pie corto (3 uds.)	CAX204 / CAX206 / CAX208 / CAX212	
CAX022		Tornillería completa / CAX	CAX204 / CAX206 / CAX208 / CAX212	
CORTADOR DE TOMATES EN RODAJAS				
CTXM55	GX016-12	Ventosa y anillo - lote de 12	CTXM55	
	GX017-4	Pie de acero inox corto - lote de 4	CTXM55	
	CTXM08	Juego de 8 cuchillas	CTXM55	
	CTXM010-10	Arandela blanca - lote de 10	CTXM55	
	CTXM011-2	2 varillas roscadas & soportes + tornillería	CTXM55	
	OE29046	Mango para palanca	CTXM55	
	CTX019	Mango completo (con eje + tornillos)	CTXM55	
	CTXM07	Mango + 2 tornillos	CTXM55	
	CTXM09	Placa inox del pulsador	CTXM55	
	CTXM014	Corredera blanca HD	CTXM55	
	CTXM10	Soporte del brazo pulsador	CTXM55	

Familia	Ref.	Designación			
CTX	CTX016	Placa de plástico / pulsador - lote del 11		CTX	
	CTX012M	Juego de 11 cuchillas montadas + tornillos		CTX	
	CTX012	Juego de 11 cuchillas		CTX	
	GX017-4	Pie de acero inox corto - lote de 4		CTX	
	GX016-12	Ventosa y anillo - lote de 12		CTX	
	190CL-20	Pie antideslizante / tope - lote de 20		CTX	
	CTX24-2	Pasador de seguridad + cadena - x2		CTX	
	OE29046	Mango para palanca		CTX	
	CTX019	Mango completo (con eje + tornillos)		CTX	
	CTX22	8 tornillos para cuchillas (tensión)		CTX	
	CTX25	Soporte del brazo pulsador (sin tornillos)		CTX	
	CTX014	Brazo pulsador - sin mango - sin placa pulsadora		CTX	
	CTX032-2	Eje de cuchilla - lote de 2		CTX	
	CTX026	Barra guía soporte pulsador - x1		CTX	
	CTX028	Separador/ arandela inox del pulsador		CTX	
	CTX20-8	Arandela inox perforada / cuchilla - lote de 8		CTX	
	CTX21-16	Arandela inox / cuchilla - lote de 16		CTX	
	CTX031	Porta cuchillas		CTX	
	CTX030	Base inox		CTX	
	CTX40	GX017-4	Pie de acero inox corto - lote de 4		CTX40
GX016-12		Ventosa y anillo - lote de 12		CTX40	
190CL-20		Pie antideslizante / tope - lote de 20		CTX40	
CTX015		Juego de 14 cuchillas		CTX40	
CTX030		Base inox		CTX40	
CTX25		Soporte del brazo pulsador (sin tornillos)		CTX40	
CTX026		Barra guía soporte pulsador - x1		CTX40	
CTX24-2		Pasador de seguridad + cadena - x2		CTX40	
CTX019		Mango completo (con eje + tornillos)		CTX40	
OE29046		Mango para palanca		CTX40	
CTX027		Placa pulsadora inox - calado		CTX40	
CTX014		Brazo pulsador - sin mango - sin placa pulsadora		CTX40	
CTX029-2		Eje para el mantenimiento de las cuchillas x2		CTX40	
CT-MZ	GX017-4	Pie de acero inox corto - lote de 4		CT-MZ	
	GX016-12	Ventosa y anillo - lote de 12		CT-MZ	
	190CL-20	Pie antideslizante / tope - lote de 20		CT-MZ	
	LT20S006	Juego de 11 cuchillas montadas + tornillos		CT-MZ	
	LT20S007	Juego de 11 cuchillas		CT-MZ	
	LT20S004	Placa del pulsador x12 + tornillos		CT-MZ	
	OE29046	Mango para palanca		CT-MZ	
	CTX019	Mango completo (con eje + tornillos)		CT-MZ	
	CTX030	Base inox		CT-MZ	
	CTX031	Porta cuchillas		CT-MZ	
	CTX026	Barra guía soporte pulsador - x1		CT-MZ	
	CTX24-2	Pasador de seguridad + cadena - x2		CT-MZ	
	LT20S005	Brazo pulsador + mango - sin placa pulsadora		CT-MZ	
	CTX20-8	Arandela inox perforada / cuchilla - lote de 8		CT-MZ	
	CTX21-16	Arandela inox / cuchilla - lote de 16		CT-MZ	
	CTX032-2	Eje de cuchilla - lote de 2		CT-MZ	
	CTX22	8 tornillos para cuchillas (tensión)		CT-MZ	
	COCEDOR DE ARROZ				
	N8900	N8900-CU	Recipiente removible		N8900
		N8900-03	Termostato magnético / N8900		N8900
N8900-09		Fusible		N8900	
N8900-10		Termostato 68° C		N8900	
N8900-15		Interruptor principal		N8900	
N8900-04		Base caliente		N8900	
N8900-06		Elemento caliente circular / N8900		N8900	
N8900-08		Conmutador eléctrico / N8900		N8900	

Familia	Ref.	Designación		
N8094	N8094-CU	Interruptor / N8094		N8094
	N8094-T	Termostato		N8094
	N8094-TC	Termocontacto / N8094		N8094
	N8094-R	Resistencia de calentamiento		N8094
	N8094-B	Interruptor on-off		N8094
	N8094-C	Recipiente de aluminio anti adherente		N8094
	N8094-CO	Tapa		N8094
	N8094-HB	Base caliente		N8094

PELADOR DE PINAS MANUAL

EA	EA001	Cuchilla de acero inox Ø 89 mm / EA		EA. / EA95 / EA105
	EA002	Empujador Ø 89 mm / EA		EA. / EA95 / EA105
	EA003	Cuchilla de acero inox Ø 74 mm / EA		EA. / EA95 / EA105
	EA004	Empujador Ø 74 mm / EA		EA. / EA95 / EA105
	EA005	Cuchilla de acero inox Ø 102 mm / EA		EA. / EA95 / EA105
	EA006	Empujador Ø 102 mm / EA		EA. / EA95 / EA105
	EA007	Cuchilla de acero inox Ø 95 mm / EA		EA. / EA95 / EA105
	EA008	Empujador Ø 95 mm / EA		EA. / EA95 / EA105
	EA009	Cuchilla de acero inox para mango		EA. / EA95 / EA105
	EA010	Empujador para mango		EA. / EA95 / EA105
	EA013	Cuchilla de acero inox 6 secciones / EA		EA. / EA95 / EA105
	EA014	Empujador 6 secciones / EA		EA. / EA95 / EA105
	EA-GP-5	Pasador del pulsador - lote de 5		EA. / EA95 / EA105
	EA35089-2	Tornillo de cuchilla - lote de 2		EA. / EA95 / EA105
	GX016-12	Ventosa y anillo - lote de 12		EA. / EA95 / EA105
	GX017-4	Pie de acero inox corto - lote de 4		EA. / EA95 / EA105
	EA35060	2 topes de sujeción de la cuchilla (anterior y posterior)		EA. / EA95 / EA105
	OE29046	Mango para palanca		EA. / EA95 / EA105

PELADOR DE PINAS ELECTRICA

EA-EL	EA001	Cuchilla de acero inox Ø 89 mm / EA		EA-EL
	EA002	Empujador Ø 89 mm / EA		EA-EL
	EA003	Cuchilla de acero inox Ø 74 mm / EA		EA-EL
	EA004	Empujador Ø 74 mm / EA		EA-EL
	EA005	Cuchilla de acero inox Ø 102 mm / EA		EA-EL
	EA006	Empujador Ø 102 mm / EA		EA-EL
	EA007	Cuchilla de acero inox Ø 95 mm / EA		EA-EL
	EA008	Empujador Ø 95 mm / EA		EA-EL
	EA009	Cuchilla de acero inox para mango		EA-EL
	EA010	Empujador para mango		EA-EL
	EA013	Cuchilla de acero inox 6 secciones / EA		EA-EL
	EA014	Empujador 6 secciones / EA		EA-EL
	EA-GP-5	Pasador del pulsador - lote de 5		EA-EL
	EA35089-2	Tornillo de cuchilla - lote de 2		EA-EL
	GX016-12	Ventosa y anillo - lote de 12		EA-EL
	GX017-4	Pie de acero inox corto - lote de 4		EA-EL
	EA-ELS01	Botón on-off - lote de 2		EA-EL
	EA-ELS02	Motor lineal completo		EA-EL
EA-ELS03	Caja de alimentación cableada		EA-EL	
EA-ELS04	Distribución por cable		EA-EL	
EA35060	2 topes de sujeción de la cuchilla (anterior y posterior)		EA-EL	

PELADOR

EP EPX ESJX EM EMX	E0010.	Cabeza + pulsador / zanahorias		EMX001 à EMX004 / EM001 à EM004 / EPX001 à EPX004 / EP001 à EP004 / ESJX001 à ESJX04
	E0011.	Cabeza + pulsador / zanahorias grandes		EMX001 à EMX004 / EM001 à EM004 / EPX001 à EPX004 / EP001 à EP004 / ESJX001 à ESJX05
	E0012.	Cabeza pepinos		EMX001 à EMX004 / EM001 à EM004 / EPX001 à EPX004 / EP001 à EP004 / ESJX001 à ESJX06
	E0015	Pie epoxy		EP001 / EP002 / EP003 / EP004
	EX0015	Pie de acero inox		EPX001 / EPX002 / EPX003 / EPX004
	E0014	Fijación mural epoxy		EM001 / EM002 / EM003 / EM004
	EX0014	Fijación mural inox		EMX001 / EMX002 / EMX003 / EMX004
	PSJX	Fijación brida inox		ESJX001 / ESJX002 / ESJX003 / ESJX004
	N5121	Cuchilla zanahorias x6		EMX001 / EM001 / EPX001 / EP001 / ESJX001

Familia	Ref.	Designación	
	N5122	Cuchilla pepinos x6	EMX003 / EM003 / EPX003 / EP003 / ESJX003
	N5127	Cuchilla zanahorias grandes x6	EMX002 / EM002 / EPX002 / EP002 / ESJX002
	E0017	Platina de plástico / zanahoria	EMX001 / EM001 / EPX001 / EP001 / ESJX001
	E0018	Platina de plástico / zanahoria grande - pepino	EMX002 / EM002 / EPX002 / EP002 / ESJX002
	E0016.	Pulsador zanahorias / zanahorias grandes	EMX001 / EMX002 / EM001 / EM002 / EPX001 / EPX002 / ESJX001 / ESJX002
	N5124	Juego de 6 muelles para zanahorias / zanahorias grandes / pepinos	EMX001 à EMX003 / EM001 à EM003 / EPX001 à EPX003 / EP001 à EP003 / ESJX001 à ESJX003
	N5140	Soporte corto x2 / zanahorias grandes - pepinos	EMX002 / EMX003 / EM002 / EM003 / EPX002 / EPX003 / ESJX002 / ESJX003 / EP002 / EP003
	N5141	Soporte mediano x2 / zanahorias grandes - pepinos	EMX002 / EMX003 / EM002 / EM003 / EPX002 / EPX003 / ESJX002 / ESJX003 / EP002 / EP003
EP EPX ESJX EM EMX	N5142	Soporte largo x2 / zanahorias grandes - pepinos	EMX002 / EMX003 / EM002 / EM003 / EPX002 / EPX003 / ESJX002 / ESJX003 / EP002 / EP003
	N5130	Soporte corto x2 / zanahorias	EMX001 / EM001 / EPX001 / EP001 / ESJX001
	N5131	Soporte mediano x2 / zanahorias	EMX001 / EM001 / EPX001 / EP001 / ESJX001
	N5132	Soporte largo x2 / zanahorias	EMX001 / EM001 / EPX001 / EP001 / ESJX001
	E0019.	Cabeza espárragos	EMX001 à EMX004 / EM001 à EM004 / EPX001 à EPX004 / EP001 à EP004 / ESJX001 à ESJX004
	N5120	Cuchilla espárragos x2	MLT.
	N5125	Juego de 6 muelles para espárragos	EMX004 / EM004 / EPX004 / EP004 / ESJX004
	N5143	Soporte corto x2 / espárragos	EMX004 / EM004 / EPX004 / EP004 / ESJX004
	N5144	Soporte mediano x2 / espárragos	EMX004 / EM004 / EPX004 / EP004 / ESJX004
	N5145	Soporte largo x2 / espárragos	EMX004 / EM004 / EPX004 / EP004 / ESJX004
	E0015	Pie epoxy	EP001 / EP002 / EP003 / EP004
	EX0015	Pie de acero inox	EPX001 / EPX002 / EPX003 / EPX004

PELADORES

	N4220-B	Brazo de sujeción / N4220	N4220
	N4220-BC	Brazo circular completo / N4220 / N4221	N4220 / N4221
	N4220-CI	Tapón del interruptor / N4220 / N4221	N4220
	N4220-COR	Cable de alimentación / N4220 / N4221	N4220 / N4221
N4220 N4221	N4220-DI	Interruptor 2 velocidades / N4220 / N4221	N4220 / N4221
	N4220-I	Interruptor - rojo / N4220 / N4221	N4220 / N4221
	N4220-PIT	Piñon de entrenamiento para tridente / N4220 / N4221	N4220 / N4221
	N4221-PI	Punta de plástico para brazo de sujeción / N4221	N4221
	N4220-PL	Punta inox para brazo de sujeción / N4220	N4220
N4225	N4225-M	Manivela / N4225	N4225
	N4225-MP	Soporte plástico amarillo del fruto / N4225	N4225

CORTABAGUET

	F001	Hoja inox	FVX1
FVX1	O2898	Tornillo inox para soporte brida con barrita blanca	FVX1
	O2879-10	Barrita blanca para tornillo de soporte brida - lote de 10	FVX1
	F003	Muelle para compresión	FVX1

AHUMADERO

FAF FAFR	FAF01	Resistencia de calentamiento	FAF/FAFR
----------	-------	------------------------------	----------

GUIARA

	GX011	Bloque de corte 5 mm	GX01 / GX02 / GX03 / GX04 / GX05 / GX06
	GX013	Bloque de corte 10 mm	GX01 / GX02 / GX03 / GX04 / GX05 / GX06
	GX051	Bloque de corte 7 mm	GX01 / GX02 / GX03 / GX04 / GX05 / GX06
	GX012	Soporte redondo 5 mm	GX01 / GX02 / GX03 / GX04 / GX05 / GX06
	GX014	Soporte redondo 10 mm	GX01 / GX02 / GX03 / GX04 / GX05 / GX06
	GX052	Soporte redondo 7 mm	GX01 / GX02 / GX03 / GX04 / GX05 / GX06
GX	GX022	Soporte plano 5 mm	GX01 / GX02 / GX03 / GX04 / GX05 / GX06
	GX024	Soporte plano 10 mm	GX01 / GX02 / GX03 / GX04 / GX05 / GX06
	GX053	Soporte plano 7 mm	GX01 / GX02 / GX03 / GX04 / GX05 / GX06
	GX015-2	Juego de hilos inox de repuesto - 8 x 2	GX01 / GX02 / GX03 / GX04 / GX05 / GX06
	GX017-4	Pie de acero inox corto - lote de 4	GX01 / GX02 / GX03 / GX04 / GX05 / GX06
	GX016-12	Ventosa y anillo - lote de 12	GX01 / GX02 / GX03 / GX04 / GX05 / GX06
	OE7518	Tornillo de bloqueo	GX01 / GX02 / GX03 / GX04 / GX05 / GX06

Familia	Ref.	Designación		
GXM	GXM013	Bloque de corte 10 mm		GXM03 / GXM04 / GXM05 / GXM06
	GXM051	Bloque de corte 7 mm		GXM03 / GXM04 / GXM05 / GXM06
	GXM012	Soporte redondo 10 mm		GXM03 / GXM04 / GXM05 / GXM06
	GXM052	Soporte redondo 7 mm		GXM03 / GXM04 / GXM05 / GXM06
	GXM022	Soporte plano 10 mm		GXM03 / GXM04 / GXM05 / GXM06
	GXM053	Soporte plano 7 mm		GXM03 / GXM04 / GXM05 / GXM06
	GXM015-2	Juego de hilos inox de repuesto - 4 x 6		GXM03 / GXM04 / GXM05 / GXM06
	GX017-4	Pie de acero inox corto - lote de 4		GX01 / GX02 / GX03 / GX04 / GX05 / GX06
	GX016-12	Ventosa y anillo - lote de 12		GX01 / GX02 / GX03 / GX04 / GX05 / GX06
	GXM016-6	Tornillo tensor para GXM - lote de 6		GXM03 / GXM04 / GXM05 / GXM06
	OE7518	Tornillo de bloqueo		GX01 / GX02 / GX03 / GX04 / GX05 / GX06

PICADORA

HV5 HV12 HV22 HV12-EL HV5-EL HV22-EL HV22-XEL	HV1222CT5-ENG	Juego de 3 piñones ára motor / HV12 / HV22 / CT5		HV12 / HV22 / CT5
	HV1222J	Junta / HV12 / HV22		HV12 / HV22
	HV1222-PIL	Pilón empujador / HV12 / HV22		HV12 / HV22
	HV1222-PL	Bandeja / HV12 / HV22		HV12 / HV22
	HV1222-SOC	Base para HV12 / HV22 / CTX5-EL		HV12 / HV22
	HV12-C	Cuchilla / HV12		HV12
	HV12-CAP-HEL	Capó helice para motor 0,40 / HV12 / CT5X-EL4		HV12 / CT5X-EL4
	HV12-CARRE	Cuadrado de tornillo sin fin / HV12-EL		HV12-EL
	HV12-CO	Condensador / HV12-EL		HV12-EL
	HV12-CORPS	Cuerpo de fundición / HV12		HV12
	HV12-COUR	Tuerca plástica para embolsar		HV12
	HV12-CR	Tapa reductor / HV12 / HV22 + anilla lubricante		HV12 / HV22
	HV12-CRJ	Junta brida reductor / HV12 / HV22		HV12 / HV22
	HV12-ELM	Motor / HV12-EL		V12-EL
	HV12-ENT15	Embudo salchichas 1,5 cm / HV12		HV12
	HV12-ENT25	Embudo salchichas 2,5 cm / HV12		HV12
	HV12-G10	Rejilla 10 mm / HV12		HV12
	HV12-G12	Rejilla 12 mm / HV12		HV12
	HV12-G14	Rejilla 14 mm / HV12		HV12
	HV12-G16	Rejilla 16 mm / HV12		HV12
	HV12-G18	Rejilla 18 mm / HV12		HV12
	HV12-G20	Rejilla 20 mm / HV12		HV12
	HV12-G3	Rejilla 3 mm / HV12		HV12
	HV12-G4.5	Rejilla 4,5 mm / HV12		HV12
	HV12-G6	Rejilla 6 mm / HV12		HV12
	HV12-G8	Rejilla 8 mm / HV12		HV12
	HV12-HEL	Helice / HV12		HV12
	HV12-JNT	Interruptor on-off / HV12-EL / HV5-EL		HV12-EL / HV5-EL
	HV12-VIR	Virola / HV12-EL		HV12-EL
	HV12-VIS	Tornillo sin fin / HV12		HV12
	HV22-C	Cuchilla / HV22		HV22
	HV22-CAP-HEL	Capó helice / HV22-EL		HV22-EL
	HV22-CARRE	Cuadrado del eje sin fin / HV22-EL		HV22-EL
	HV22-CO	Condensador / HV22-EL		HV22
	HV22-CORPS	Cuerpo de fundición / HV22		HV22
	HV22-COUR	Tuerca plástica para embolsar		HV22-EL / HV22-XEL
	HV22-CX	Cuchilla / HV22-XEL		HV22-XEL
	HV22-ELM	Motor / HV22-EL		HV22-EL
	HV22-ENT15	Embudo de salchichas 1,5 cm / HV22		HV22
	HV22-ENT20	Embudo de salchichas 2 cm / HV22		HV22
	HV22-ENT25	Embudo de salchichas 2,5 cm / HV22		HV22
	HV22-G10	Rejilla 10 mm / HV22		HV22
	HV22-G12	Rejilla 12 mm / HV22		HV22
	HV22-G14	Rejilla 14 mm / HV22		HV22
	HV22-G16	Rejilla 16 mm / HV22		HV22
	HV22-G18	Rejilla 18 mm / HV22		HV22
	HV22-G20	Rejilla 20 mm / HV22		HV22
	HV22-G3	Rejilla 3 mm / HV22		HV22
	HV22-G4.5	Rejilla 4,5 mm / HV22		HV22
	HV22-G6	Rejilla 6 mm / HV22		HV22

Familia	Ref.	Designación		
	HV22-G8	Rejilla 8 mm / HV22		HV22
	HV22-GX10	Rejilla inox 10 mm / HV22-XEL		HV22-XEL
	HV22-GX12	Rejilla inox 12 mm / HV22-XEL		HV22-XEL
	HV22-GX14	Rejilla inox 14 mm / HV22-XEL		HV22-XEL
	HV22-GX16	Rejilla inox 16 mm / HV22-XEL		HV22-XEL
	HV22-GX18	Rejilla inox 18 mm / HV22-XEL		HV22-XEL
	HV22-GX20	Rejilla inox 20 mm / HV22-XEL		HV22-XEL
	HV22-GX4.5	Rejilla inox 4,5 mm / HV22-XEL		HV22-XEL
	HV22-GX6	Rejilla inox 6 mm / HV22-XEL		HV22-XEL
	HV22-GX8	Rejilla inox 8 mm / HV22-XEL		HV22-XEL
	HV22-HEL	Helice / HV22		HV22
	HV22-INT	Interruptor on-off / HV22-EL		HV22-EL
	HV22-PE	Prensa estopa / HV22-EL		HV5-EL
	HV22-VIR	Virola / HV22		HV22
	HV22-VIS	Tornillo sin fin / HV22		HV22
	HV5-C	Cuchilla / HV5		HV5
	HV5-CAP-HEL	Capó helice / HV5-EL		HV5-EL
	HV5-CORPS	Cuerpo de fundición / HV5		HV5
HV5	HV5-COUR	Tuerca plástica para embolsar		HV5
HV12	HV5-CR	Tapa reductor + anillo lubricante		HV5
HV22	HV5-CR-J	Junta brida reductor / HV5		HV5
HV12-EL	HV5CT3-ENG	2 engranajes para motor / HV5 / CT3		HV5 / CT3
HV5-EL	HV5-ELM	Motor / HV5-EL		HV5-EL
HV22-EL	HV5-ENG-P	Engranaje pequeño / HV5		HV5
HV22-XEL	HV5-ENT15	Embudo de salchichas 1,5 cm / HV5		HV5
	HV5-ENT20	Embudo de salchichas 2 cm / HV5		HV5
	HV5-ENT25	Embudo de salchichas 2,5 cm / HV5		HV5
	HV5-G10	Rejilla 10 mm / HV5		HV5
	HV5-G4.5	Rejilla 4,5 mm / HV5		HV5
	HV5-G6	Rejilla 6 mm / HV5		HV5
	HV5-G8	Rejilla 8 mm / HV5		HV5
	HV5-HEL	Helice / HV5		HV5
	HV5-INT	interruptor on-off / HV5-EL		HV5
	HV5-J	Junta de sellado para el tapa del reductor / HV5-EL		HV5-EL
	HV5-PIL	Pilón empujador / HV5		HV5
	HV5-PL	Bandeja para HV5		R HV5
	HV5-SOC	Base / HV5		HV5
	HV5-VIR	Virola / HV5-EL		HV5
	HV5-VIS	Eje sin fin + cuadrado del eje / HV5-EL		HV5-EL
	HVCT-HUILE	Aceite para motoreductor / HV		HV22
	N5600-A	Anillo junta / N5600		N5600
	N5600-AC	Eje de la cuchilla / N5600		N5600
	N5600-AX	Eje de salida motor / N5600		N5600
	N5600-B	Collar de ajuste / N5600		N5600
	N5600-CAD	Cuadro de fundo / N5600		N5600
	N5600-CAP	Carcasa plástico sola / N5600		N5600
	N5600-E	Empujador de carne plástico / N5600		N5600
N5600	N5600-IC	Interruptor completo / N5600		N5600
	N5600-M	Motor / N5600		N5600
	N5600-P	Bandeja / N5600		N5600
	N5600-PI	Piñon de salida / N5600		N5600
	N5600-PM	Piñon metalico intermedio / N5600		N5600
	N5600-PP	Piñon plástico de fondo / N5600		N5600
	N5600-T	Cabeza del picador / N5600		N5600
	N5600-V	Tornillo sin fin / N5600		N5600
PICADORAS MANUAL HOJELATAS				
	N40504C	Rejilla Ø 4,5 mm / N4005C		N4005C
	N40506C	Rejilla Ø 6,5 mm / N4005C		N4005C
N4005C	N40508C	Rejilla Ø 8 mm / N4005C		N4005C
N4008C	N40804C	Rejilla Ø 4,5 mm / N4008C		N4008C
N4010C	N40806C	Rejilla Ø 6,5 mm / N4008C		N4008C
	N40808C	Rejilla Ø 8 mm / N4008C		N4008C
	N40812C	Rejilla Ø 12 mm / N4008C		N4008C

Familia	Ref.	Designación			
N4005C N4008C N4010C	N40104C	Rejilla Ø 4,5 mm / N4010C		N4010C	
	N40106C	Rejilla Ø 6,5 mm / N4010C		N4010C	
	N40108C	Rejilla Ø 8 mm / N4010C		N4010C	
	N40112C	Rejilla Ø 12 mm / N4010C		N4010C	
	N40115C	Rejilla Ø 15 mm / N4010C		N4010C	
	N4005C-B	Anillo de ajuste / N4005C		N4005C	
	N40051C	Cuchilla / N4005C		N4005C	
	N4005C-BP	Anillo de plástico para tornillo sin fin / N4005C		N4005C	
	N4005C-M	Manivela / N4005C		N4005C	
	N4005C-VF	Tornillo de fijación de la manivela / N4005C		N4005C	
	N4005C-V	Tornillo sin fin / N4005C		N4005C	
	N4008C-B	Anillo de ajuste / N4008C		N4008C	
	N40081C	Cuchilla 4 brazos / N4008C		N4008C	
	N4008C-BP	Anillo de plástico para tornillo sin fin / N4008C		N4008C	
	N4008C-M	Manivela / N4008C		N4008C	
	N4008C-VF	Tornillo de fijación de la manivela / N4008C		N4008C	
	N4008C-V	Tornillo sin fin / N4008C		N4008C	
	N4010C-B	Anillo de ajuste / N4010C		N4010C	
	N40101C	Cuchilla 4 brazos / N4010C		N4010C	
	N4010C-BP	Anillo de plástico para tornillo sin fin / N4010C		N4010C	
	N4010C-M	Manivela / N4010C		N4010C	
	N4010C-VF	Tornillo de fijación de la manivela / N4010C		N4010C	
	N4010C-V	Tornillo sin fin / N4010C		N4010C	
	N4005C-S	3 embudos de salchichas Ø13, 17 & 19 mm / N4005C		N4005C	
	N4008C-S	3 embudos de salchichas Ø13, 17 & 19 mm / N4008C		N4008C	
	N4010C-S	3 embudos de salchichas Ø13, 17 & 19 mm / N4010C		N4010C	
	N4022C N4032C	N40204C	Rejilla Ø 4,5 mm / N4022C		N4022C
		N40206C	Rejilla Ø 6,5 mm / N4022C		N4022C
		N40208C	Rejilla Ø 8 mm / N4022C		N4022C
		N40212C	Rejilla Ø 12 mm / N4022C		N4022C
		N40215C	Rejilla Ø 15 mm / N4022C		N4022C
		N40221C	Cuchilla / N4022C		N4022C
		N4022C-B	Anillo de ajuste / N4022C		N4022C
N4022C-BP		Anillo de plástico para tornillo sin fin / N4022C		N4022C	
N4022C-M		Manivela / N4022C		N4022C	
N4022C-S		Embudos de salchichas Ø13, 17 & 19 mm / N4022C		N4022C	
N4022C-V		Tornillo sin fin / N4022C		N4022C	
N4022C-VF		Tornillo de fijación de la manivela / N4022C		N4022C	
N40304C		Rejilla Ø 4,5 mm / N4032C		N4032C	
N40306C		Rejilla Ø 6,5 mm / N4032C		N4032C	
N40308C		Rejilla Ø 8 mm / N4032C		N4032C	
N40312C		Rejilla Ø 12 mm / N4032C		N4032C	
N40315C		Rejilla Ø 15 mm / N4032C		N4032C	
N40321C		Cuchilla / N4032C		N4032C	
N4032C-B		Anillo de ajuste / N4032C		N4032C	
N4032C-BP		Anillo de plástico para tornillo sin fin / N4032C		N4032C	
N4032C-M		Manivela / N4032C		N4032C	
N4032C-S		Embudos de salchichas Ø13, 17 & 19 mm / N4032C		N4032C	
N4032C-V		Tornillo sin fin / N4032C		N4032C	
N4032C-VF	Tornillo de fijación de la manivela / N4032C		N4032C		
PICADORAS MANUAL ACERO INOXIDABLE					
N4008CX N4010CX	N40081CX	Cuchilla inox / N4008CX		N4008CX	
	N4008CX-B	Anillo de ajuste / N4008CX		N4008CX	
	N4008CX-M	Manivela / N4008CX		N4008CX	
	N40101CX	Cuchilla inox / N4010CX		N4010CX	
	N40104CX	Rejilla inox Ø 4,5 mm / N4010CX		N4010CX	
	N40106CX	Rejilla inox Ø 6,5 mm / N4010CX		N4010CX	
	N40108CX	Rejilla inox Ø 8 mm / N4010CX		N4010CX	
	N4010CX-B	Anillo de ajuste / N4010CX		N4010CX	
	N4010CX-M	Manivela / N4010CX		N4010CX	
	N40112CX	Rejilla inox Ø 12 mm / N4010CX		N4010CX	
	N40115CX	Rejilla inox Ø 15 mm / N4010CX		N4010CX	
	N40804CX	Rejilla inox Ø 4,5 mm / N4008CX		N4008CX	

Familia	Ref.	Designación			
N4008CX N4010CX	N40806CX	Rejilla inox Ø 6,5 mm / N4008CX		N4008CX	
	N40808CX	Rejilla inox Ø 8 mm / N4008CX		N4008CX	
	N40812CX	Rejilla inox Ø 12 mm / N4008CX		N4008CX	
	N4008CX-V	Tornillo sin fin / N4008CX		N4008CX	
	N4010CX-V	Tornillo sin fin / N4010CX		N4010CX	
ENVASADORA AL VACIO					
	NV400-8	Junta de sellado (espuma) / NV400		NV400	
	NV400-C	Tarjeta electrónica / NV400		NV400	
MAQUINA TALLADORA DE HORTALIZAS					
MLT	GX017-4	Pie de acero inox corto - lote de 4		MLT.	
	GX016-12	Ventosa y anillo - lote de 12		MLT.	
	MLT01.	Cuchilla inox de repuesto		MLT.	
	MLT02-3	Tornillo de hoja - lote de 6		MLT.	
	MLT03	Juego porta cuchilla izquierda y derecha		MLT.	
	MLT04-2	Rueda regulación de la hoja + arandela - lote de 2		MLT.	
	O2873-5	Arandela courbhane + arandela de metal - lote de 5		MLT.	
	MLT05	Punta / soporte		MLT.	
	MLT06	Ajuste de tope de la cuchilla		MLT.	
	MLT07	Botón moleteado / rotación		MLT.	
	MLT37585-7	Rodamiento de bolas x7		MLT.	
	MLT37530	Palanca giratoria portacuchilla x2		MLT.	
MAQUINA DE PASTA					
N8001 N8001C N8004 N8005 N7994	N8001-ACC	Accesorio doble (spaghetti + tagliatelle) / N8001 / N7994		N8001 / N7994	
	N8001C-ACC	Accesorio doble (spaghetti + tagliatelle) / N8001C		N8001C	
	N8001-V	Fijación brida / N8001		N8001	
	N8004T	Embudo plástico para accesorio ravioli N8004		N8004	
	N8005P	Piñon / N8005		N8005	
N7900	N7900-M	Manivela / N7900		N7900	
	N7900-P	Lote de 4 pies / N7900		N7900	
	N7900-SJ	Fijación brida / N7900		N7900	
MANDOLINA					
10000 15000 25000	10201	Pulsador de seguridad (plástico negro)		15000 / 25000	
	15210	Cuchilla central gofrada (ondulada)		15000	
	10216	Cuchilla central lisa + tuerca moleteada		15000 / 10000	
	10202	Bloque de corte 2 mm		15000 / 10000 / 25000	
	10210	Bloque de corte 10 mm		15000 / 10000 / 25000	
	10201-3	Bloque de corte 1 mm		15000 / 10000 / 25000	
	15020-N	Pie desmontable / reversible negro)		15000	
	10211	Caja con 4 bloques de corte (2 - 4 - 7 & 10 mm)		15000 / 10000 / 25000	
	10213	Caja con 3 bloques de corte (1 - 2 & 4 mm)		15000 / 10000 / 25000	
	10204	Bloque de corte 4 mm		15000 / 10000 / 25000	
	10207	Bloque de corte 7 mm		15000 / 10000 / 25000	
	10201-LV	Pulsador de seguridad (plástico rojo)		10000	
	15020-LV	Pie desmontable / reversible (rojo)		10000	
	10207	Bloque de corte 7 mm		15000 / 10000 / 25000	
	190CL-20	Pie antideslizante / tope - lote de 20		25000	
	181CL-5	Apoyo de borde de mesa - lote de 5		25000	
	30300	Carro protector armazón inox - mango plástico		25000	
	30400	Carro protector armazón inox - mango de madera		25000	
	10215	Placa de cuchillos liso y gofre		25000	
	166CL	le pegable inox (sin apoyo borde de mesa)		25000	
	20638B 20644B 20660B 20638CHB 20644CHB 20660CHB 20638CHBB 20644CHBB 20660CHBB 21038 21044 21060	190CL-20	Pie antideslizante / tope - lote de 20		20638B-44B-60B-38CHB-44CHB-60CHB-38CHBB-44CHBB-60CHBB-21038 / 21044 / 21060
		176CL	Cuchilla central / hoja lisa		20638B-44B-60B-38CHB-44CHB-60CHB-38CHBB-44CHBB-60CHBB-21038 / 21044 / 21060
		30300	Carro protector armazón inox - mango plástico		20638B-44B-60B-38CHB-44CHB-60CHB-38CHBB-44CHBB-60CHBB-21038 / 21044 / 21060
		30400	Carro protector armazón inox - mango de madera		20638B-44B-60B-38CHB-44CHB-60CHB-38CHBB-44CHBB-60CHBB-21038 / 21044 / 21060
		10201	Pulsador de seguridad (plástico negro)		20638B-44B-60B-38CHB-44CHB-60CHB-38CHBB-44CHBB-60CHBB-21038 / 21044 / 21060
	19638	Peine para mandolina 38 hojas (3 y 10 mm) - sin manivella		20638B-44B-60B-38CHB-44CHB-60CHB-38CHBB-44CHBB-60CHBB-21038 / 21044 / 21060	

Familia	Ref.	Designación		
20638B 20644B 20660B 20638CHB 20644CHB 20660 CHB 20638CHBB 20644CHBB 20660CHBB 21038 21044 21060	10644	Peine para mandolina 44 hojas (3 y 7 mm) - sin manivella	20638B-44B-60B-38CHB-44CHB-60CHB-38CHBB-44CHBB-60CHBB-21038 / 21044 / 21060	
	11660	Peine para mandolina 60 hojas (2 y 4,5 mm) - sin manivella	20638B-44B-60B-38CHB-44CHB-60CHB-38CHBB-44CHBB-60CHBB-21038 / 21044 / 21060	
	183CL	Manivela para peine	20638B-44B-60B-38CHB-44CHB-60CHB-38CHBB-44CHBB-60CHBB-21038 / 21044 / 21060	
	126CL	Placa cuchilla gofre	20638B-44B-60B-38CHB-44CHB-60CHB-38CHBB-44CHBB-60CHBB-21038 / 21044 / 21060	
	181CL-5	Poyo de borde de mesa - lote de 5	20638B-44B-60B-38CHB-44CHB-60CHB-38CHBB-44CHBB-60CHBB-21038 / 21044 / 21060	
	146CL	Placa superior	20638B-44B-60B-38CHB-44CHB-60CHB-38CHBB-44CHBB-60CHBB-21038 / 21044 / 21060	
	166CL	Pie pegable inox (sin apoyo borde de mesa)	20638B-44B-60B-38CHB-44CHB-60CHB-38CHBB-44CHBB-60CHBB-21038 / 21044 / 21060	
MANDOLINA PAR TRUFAS				
1010CT	1070CT	Cuchilla inox + tornillo de fijación + llave		1010CT
	1042CT	Kit regulador de espesor de corte : botón moleta + pata + 2 tornillos		1010CT
MANDOLINA JAPONESA				
120JB 95JB 8485JAPGN 64JB 8486JAPP 8490JAPP	120FL	Hoja plana / 120JB / 95JB / 8484JAPJ		120JB / 95JB / 8485JAPGN
	120PO	Empujador / 120JB / 8484JAPJ		120JB / 8485JAPGN
	64FL	Hoja plana / 64JB		64JB
	64PO	Empujador / 64JB / 8486JAPP		64JB / 8486JAPP
	8485BR	Tornillo reglado - dorado - redondo (antiguo modelo) / 8485JAPG		8485JAPGN
	8485BS	Tornillo triangular de sujeción para hoja (antiguo modelo) / 8485JAPG		8485JAPG
	8485FL	Hoja plana / 8485JAPG / 95JB		8485JAPGN / 95JB
	8485LA	Hoja laminadora larga / 8485JAPG / 95JB		8485JAPGN / 95JB
	8485MO	Hoja laminadora mediana / 8485JAPG / 95JB		8485JAPGN / 95JB
	8485PL	Placa (semi) triangular plástico / 8485JAPGN		8485JAPGN
	8485PO	Empujador / 8485JAPG		8485JAPGN
	8485V	Tornillo de fijación hoja plana / 8485JAPGN		8485JAPGN
	8486BR*	Tornillo reglado plástico - redondo - bajo (antiguo model) / 8486JAPP		8486JAPP
	8486BS*	Tornillo plástico triangular sujeción de peine / 8486JAPP		8486JAPP
	8486FI	Hoja laminadora fina / 8486JAPP / 8490JAPP / 64JB		8486JAPP / 8490JAPP / 64JB
	8486FL	Hoja plana / 8486JAPP		8486JAPP
	8486LA	Hoja laminadora larga / 8486JAPP / 8490JAPP / 64JB		8486JAPP / 8490JAPP / 64JB
	8486MO	Hoja laminadora mediana / 8486JAPP / 8490JAPP / 64JB		8486JAPP / 8490JAPP / 64JB
	8486PO	Empujador / 8486JAPP		8486JAPP
	848BRN	Botón de regulación metalico - abajo / 8485JAPG / 8486JAPP		8485JAPGN / 8486JAPP
	848BSN	Tornillo de fijación metalico (nuevo model)		8486JAPP/8490JAPP/8485JAPGN/64JB/95JB
	95PO	Empujador / 95JB / 8485JAPG		8485JAPGN / 95JB
	MARMITA DE SOPA			
N8060	N8060-06	Resistencia de calentamiento		N8060
	N8060-08	Termostato		N8060
	N8060-09	Fusible 133°C		N8060
	N8060-10	Recipiente de aluminio		N8060
	N8060-13	Indicador luminoso verde / N8060		N8060
	N8060-14	Termostato regulador de temperatura / N8060		N8060
	N8060-15	Interruptor / N8060		N8060
	N8060-18	Recipiente de acero inoxidable		N8060
	N8060-19	Tapa inox		N8060
	N8060-17	Collar superior del recipiente / N8060		N8060
MOLINOS				
S3	S3002	Arbol - manivela - traviesa - mango / S3		S3
	S3003-3	4 gomas de protección - lote de 3 (12 uds.) / N°3		S3
	S3004-2	Lote 2 mangos y 2 arandelas + 5 clips / S3		S3
	S3015	Rejilla estañada Ø 1,5 mm / S3		S3
	S3025	Rejilla estañada Ø 2,5 mm / S3		S3
	S3040	Rejilla estañada Ø 4 mm / S3		S3
	S3006-10	Clip x10 / N°3		S3
	S3001	Cono / S3		S3

Familia	Ref.	Designación		
X3-F	X3002	Arbol - manivela - traviesa - mango / X3		X3-F
	S3003-3	4 gomas de protección - lote de 3 (12 uds.) / N°3		X3-F
	X3004-2	Lote 2 mangos y 2 arandelas + 5 clips / X3		X3-F
	X3015	Rejilla inox Ø 1,5 mm para X3		X3-F
	X3025	Rejilla inox Ø 2,5 mm para X3		X3-F
	X3040	Rejilla inox Ø 4 mm para X3		X3-F
	S3006-10	Clip x10 / N°3		X3-F
	X3001	Cono / X3		X3-F
M5	M5002	Arbol - manivela - traviesa - mango / M5		M500 / M510 / M515 / M520 / M530 / M540
	X5003-4	Muelle de enganche - lote de 4 / N°5		M500 / M510 / M515 / M520 / M530 / M540
	M5005-2	Lote de 2 mangos y 2 arandelas + 5 clips		M500 / M510 / M515 / M520 / M530 / M540
	M5010	Rejilla estañada Ø 1 mm / M5		M500 / M510 / M515 / M520 / M530 / M540
	M5015	Rejilla estañada Ø 1,5 mm / M5		M500 / M510 / M515 / M520 / M530 / M540
	M5020	Rejilla estañada Ø 2 mm / M5		M500 / M510 / M515 / M520 / M530 / M540
	M5030	Rejilla estañada Ø 3 mm / M5		M500 / M510 / M515 / M520 / M530 / M540
	M5040	Rejilla estañada Ø 4 mm / M5		M500 / M510 / M515 / M520 / M530 / M540
	M5006-10	Clip x10 / M5 / X5 / P10		M500 / M510 / M515 / M520 / M530 / M540
	M5001	Cono estañado / M5		M500 / M510 / M515 / M520 / M530 / M540
	M5004	Soposte estañado / M5		M500 / M510 / M515 / M520 / M530 / M540
X5	X5002	Arbol - manivela - traviesa - mango / X5		X500 / X510 / X515 / X520 / X530 / X540
	X5003-4	Muelle de enganche - lote de 4 / N°5		X500 / X510 / X515 / X520 / X530 / X540
	X5005-2	Lote 2 mangos + 5 clips / X5		X500 / X510 / X515 / X520 / X530 / X540
	X5010	Rejilla inox Ø 1 mm / X5		X500 / X510 / X515 / X520 / X530 / X540
	X5015	Rejilla inox Ø 1,5 mm / X5		X500 / X510 / X515 / X520 / X530 / X540
	X5020	Rejilla inox Ø 2 mm / X5		X500 / X510 / X515 / X520 / X530 / X540
	X5030	Rejilla inox Ø 3 mm / X5		X500 / X510 / X515 / X520 / X530 / X540
	X5040	Rejilla inox Ø 4 mm / X5		X500 / X510 / X515 / X520 / X530 / X540
	M5006-10	Clip x10 / M5 / X5 / P10		X500 / X510 / X515 / X520 / X530 / X540
	X5001	Cono / X5		X500 / X510 / X515 / X520 / X530 / X540
	P10	P10001	Cono / P10	
P10002		Arbol / P10		P1000 / P1010 / P1015 / P1020 / P1030 / P1040
P10003-5		Muelle central - lote de 5		P1000 / P1010 / P1015 / P1020 / P1030 / P1040
X5003-4		Muelle de enganche - lote de 4 / N°5		P1000 / P1010 / P1015 / P1020 / P1030 / P1040
P10004		Cárter / P10		P1000 / P1010 / P1015 / P1020 / P1030 / P1040
P10005		Traviesa / P10		P1000 / P1010 / P1015 / P1020 / P1030 / P1040
P10006		Manivela + arandela + mango + clip / P10		P1000 / P1010 / P1015 / P1020 / P1030 / P1040
ONS01		Lote 2 mangos y 2 arandelas + 5 clips		P1000 / P1010 / P1015 / P1020 / P1030 / P1040
P10007		Pie tubo		P1000 / P1010 / P1015 / P1020 / P1030 / P1040
P10010		Rejilla estañada Ø 1 mm / P10		P1000 / P1010 / P1015 / P1020 / P1030 / P1040
P10015		Rejilla estañada Ø 1,5 mm / P10		P1000 / P1010 / P1015 / P1020 / P1030 / P1040
EX5	P10020	Rejilla estañada Ø 2 mm / P10		P1000 / P1010 / P1015 / P1020 / P1030 / P1040
	P10030	Rejilla estañada Ø 3 mm / P10		P1000 / P1010 / P1015 / P1020 / P1030 / P1040
	P10040	Rejilla estañada Ø 4 mm / P10		P1000 / P1010 / P1015 / P1020 / P1030 / P1040
	M5006-10	Clip x10 / M5 / X5 / P10		P1000 / P1010 / P1015 / P1020 / P1030 / P1040
	EX5010	Rejilla inox Ø 1 mm / EX5		EX5M100 / EX5M130 / EX5T100 / EX5T130
	EX5015	Rejilla inox Ø 1,5 mm / EX5		EX5M100 / EX5M130 / EX5T100 / EX5T130
	EX5020	Rejilla inox Ø 2 mm / EX5		EX5M100 / EX5M130 / EX5T100 / EX5T130
	EX5030	Rejilla inox Ø 3 mm / EX5		EX5M100 / EX5M130 / EX5T100 / EX5T130
	EX5040	Rejilla inox Ø 4 mm / EX5		EX5M100 / EX5M130 / EX5T100 / EX5T130
	E5055	Motor reductor monofásico 220v / EX5		EX5M100 / EX5M130
	E5074	Motor reductor monofásico 110v / EX5		EX5M100 / EX5M130
E5059	Motor reductor trifásico 380v / EX5		EX5T100 / EX5T130	
E5073	Interruptor monofásico con inversor		EX5M100 / EX5M130	
E5072	Interruptor trifásico con inversor		EX5T100 / EX5T130	
E5068	Botón interruptor		EX5M100 / EX5M130 / EX5T100 / EX5T130	
E5063	Reductor completo del motor - sin casquillo de aluminio		EX5M100 / EX5M130 / EX5T100 / EX5T130	
E5064	Rueda de bronce		EX5M100 / EX5M130 / EX5T100 / EX5T130	
E5065	Tornillo sin fin		EX5M100 / EX5M130 / EX5T100 / EX5T130	
E5071	Eje hexagonal hueco		EX5M100 / EX5M130 / EX5T100 / EX5T130	
EX5053	Embudo aluminio (casquillo) / EX5		EX5M100 / EX5M130 / EX5T100 / EX5T130	
EX5051	Arbol -sin muelle central / EX5		EX5M100 / EX5M130 / EX5T100 / EX5T130	
X5003-4	Muelle de enganche - lote de 4 / N°5		EX5M100 / EX5M130 / EX5T100 / EX5T130	
EX5052	Traviesa - casquillo - protección / EX5		EX5M100 / EX5M130 / EX5T100 / EX5T130	
EX5070	Soposte pie tubo inox + soporte motor		EX5M100 / EX5M130 / EX5T100 / EX5T130	

Familia	Ref.	Designación		
EX5	P10003-5	Muelle central - lote de 5		EX5M100 / EX5M130 / EX5T100 / EX5T130
	EX5050	Carter de protección		EX5M100 / EX5M130 / EX5T100 / EX5T130
	EX5069	Aro soporte		EX5M100 / EX5M130 / EX5T100 / EX5T130
	E5053	Condensador / EX5		EX5M100 / EX5M130 / EX5T100 / EX5T130
	E5054	Klixon / EX5		EX5M100 / EX5M130 / EX5T100 / EX5T130
	E5066	Embudo aluminio / EX5 (modelo viejo)		EX5M100 / EX5M130 / EX5T100 / EX5T130
	EX5001	Cono inox / EX5		EX5M100 / EX5M130 / EX5T100 / EX5T130
	E5056	Interruptor monofásico con inversor / modelo antes 2009 / EX5		EX5M100 / EX5M130
	E5057	Interruptor monofásico (sin inversor) / EX5		EX5M100 / EX5M130
	E5061	Interruptor trifásico (sin inversor) / EX5		EX5T100 / EX5T130

ABRELATAS ELECTRICOS

OEXTC	GX017-4	Pie de acero inox corto - lote de 4		OEXTC
	GX016-12	Ventosa y anillo - lote de 12		OEXTC
	OE7417	Guía corredera		OEXTC
	OE7489-2	Mango regulable de altura - lote de 2		OEXTC
	OE7492	Gato		OEXTC
	OE7518	Tornillo de bloqueo		OEXTC
	OE7554-2	Moleta Ø 36 mm - lote de 2		OEXTC
	O2830-5	Hoja inox - lote de 5		OEXTC
	OE896	Lit : hoja inox, moleta, arandelas, cepillo, llave de desmontaje		OEXTC
	OE7432	U y eje de articulación + pasador cuchilla + tornillo reglaje		OEXTC
	OE50021	Cuadrado con arandelas		OEXTC
	OE7441	Palanca con mango		OEXTC
	OE7520	Tornillo imperable con arandela		OEXTC
	OE50012	Tapa inferior		OEXTC
	OE7426	Tapa superior		OEXTC
	OE7435	Interruptor (sin capuchón)		OEXTC
	OE7434-5	Capuchón interruptor - lote del 5		OEXTC
	OE7445	Imán de retención tapa		OEXTC
	OE7551	Arandela plástico de cabeza x2		OEXTC
	OE7589	llave de desmontaje para moleta		OEXTC
	OE57257	Cable de alimentación		OEXTC
	OE50011	Eje de rotación		OEXTC
	OE7459-3	Tornillo de hoja - lote de 3		OEXTC
	OE50020	Motor - sin carcasa		OEXTC
	OE50014	Carcasa motor		OEXTC
	OE7491	Columna inox		OEXTC
	OE7405	Base inox - sin pie		OEXTC
	OEX821	Cepillo metálico Inox		OEXTC
	OE50030	Carta electrónica + filtro		OEXTC
	O2873-5	Arandela courbhane + arandela de metal - lote de 5		OEXTC
	OE7559-3	Tornillo mariposa/palanca - lote de 3		OEXTC
	OE50065	Piñon grande / reductor		OEXTC
	OE50075	Piñon pequeño / reductor		OEXTC
OE50070	Piñon intermedio / reductor		OEXTC	
OE50018	Tope de caja		OEXTC	
OE7231	Pasador de cuchilla		OEXTC	
OE7404	Eje de articulación		OEXTC	
OE50080	Carbones		OEXTC	
OE29046	Mango para palanca		OEXTC	
OE7237	Tornillo para ajustar U hoja/moleta		OEXTC	
OE50029	Soporte cabeza		OEXTC	
OE750	OE7518	Tornillo de bloqueo		OE750M / OE750T / OE750M-110
	OE7543	Gato		OE750M / OE750T / OE750M-110
	OE7502	Moletas Ø 36 & 70 mm - hoja inox - cepillo - llave de desmontaje		OE750M / OE750T / OE750M-110
	OE7575	U y eje de articulación + pasador cuchilla + barette sube palanca		OE750M / OE750T / OE750M-110
	OE7576	Palanca con mango		OE750M / OE750T / OE750M-110
	OE7565	Pulsador completo / palanca		OE750M / OE750T / OE750M-110
	OE7551	Arandela plástico de cabeza x2		OE750M / OE750T / OE750M-110
	OE7552	Eje de rotación		OE750M / OE750T / OE750M-110

Familia	Ref.	Designación		
OE750	OE7516	Motor monofásico 220v - sin carcasa		OE750M
	OE7516T	Motor trifásico 380v - sin carcasa		OE750T
	OE7534-2	Anillo de bronce guía - lote de 2		OE750M / OE750T / OE750M-110
	OE7553	Moleta Ø 70 mm		OE750M / OE750T / OE750M-110
	O2830-5	Hoja inox - lote de 5		OE750M / OE750T / OE750M-110
	OE7559-3	Tornillo mariposa/palanca - lote de 3		OE750M / OE750T / OE750M-110
	OE7520	Tornillo imperable con arandela		OE750M / OE750T / OE750M-110
	OE7524	Interruptor monofásico		OE750M / OE750M-110
	OE7610	Interruptor trifásico (caja exterior de conexión)		OE750T
	OE7554-2	Moleta Ø 36 mm - lote de 2		OE750M / OE750T / OE750M-110
	OE7589	llave de desmontaje para moleta		OE750M / OE750T / OE750M-110
	OE7503	Pedal neumático (para modelo monofásico)		OE750M / OE750M-110
	OE7506-3	Conexión tubo salida - motor / pedal de control - x 3 (monofásico)		OE750M / OE750M-110
	OE7507	Tubo salida motor / control (para modelo monofásico)		OE750M / OE750M-110
	OE7521	Imán + eje soporte imán		OE750M / OE750T / OE750M-110
	OE7556	Tornillo de hoja		OE750M / OE750T / OE750M-110
	OE7555	Cuña de hoja		OE750M / OE750T / OE750M-110
	OE7548	Cuadrado con arandelas		OE750M / OE750T / OE750M-110
	OE7598	Tope de caja		OE750M / OE750T / OE750M-110
	OE7529	Tapa inferior		OE750M / OE750T / OE750M-110
	OE7525	Tapa superior		OE750M / OE750T / OE750M-110
	OE7231	Pasador de cuchilla		OE750M / OE750T / OE750M-110
	OE7571	Columna de acero inoxidable x2		OE750M / OE750T / OE750M-110
	OE7504	Tubo inox para gato		OE750M / OE750T / OE750M-110
	OE7535	Tope de subida / motor		OE750M / OE750T / OE750M-110
	OE7562	Base inox		OE750M / OE750T / OE750M-110
	OEX821	Cepillo metálico Inox		OE750M / OE750T / OE750M-110
	OE7528	Carcasa motor		OE750M / OE750T / OE750M-110
	OE7557	Soporte cabeza		OE750M / OE750T / OE750M-110
	OE7578	Eje de articulación		OE750M / OE750T / OE750M-110
	OE7537	Condensador / OE750		OE750M / OE750T / OE750M-110
	OE29046	Mango para palanca		OE750M / OE750T / OE750M-110
	OE7567	Eje para elevación de la palanca		OE750M / OE750T / OE750M-110
	OE7570	Cable de alimentación - monofásico		OE750M / OE750T / OE750M-110

ABRELATAS MANUAL

O2P55 O2V55	O2895	Hoja, moleta, arandela rilsan, arandelas, herramienta de desmontaje	O2V55 / O2P55	
	O2830-5	Hoja inox - lote de 5	O2V55 / O2P55	
	O2870-5	Arandela de rilsan - lote de 5 / O2 / OX / OBSX	O2V55 / O2P55	
	O2877-5	Tornillo de hoja - lote de 5 / O2 / O3	O2V55 / O2P55	
	O2872-5	Placa - lote de 5 / O2 / O3	O2V55 / O2P55	
	ONS01	Lote 2 mangos y 2 arandelas + 5 clips	O2V55 / O2P55	
	O2880	Base placa para atornillar - epoxy	O2P55	
	O2890	Soporte brida - epoxy	O2V55	
	O2898	Tornillo inox para soporte brida con barrita blanca	O2V55	
	O2879-10	Barrita blanca para tornillo de soporte brida - lote de 10	O2V55	
	O2873-5	Arandela courbhane + arandela de metal - lote de 5	O2V55 / O2P55	
	O2820-2	Moleta Ø 36 mm - lote de 2	O2V55 / O2P55	
	M5006-10	Clip x10 / M5 / X5 / P10	O2V55 / O2P55	
	O2840	Manivela + mango + arandela + clip	O2V55 / O2P55	
	O2805	Cuadrado solo + 2 tornillos de fijación (sin hoja y sin moleta)	O2V55 / O2P55	
	OXP55 OXV55	O2895	Hoja, moleta, arandela rilsan, arandelas, herramienta de desmontaje	OXP55 / OXV55
		O2870-5	Arandela de rilsan - lote de 5 / O2 / OX / OBSX	OXP55 / OXV55
O2830-5		Hoja inox - lote de 5	OXP55 / OXV55	
O2820-2		Moleta Ø 36 mm - lote de 2	OXP55 / OXV55	
OXS02		Juego de 2 mangos + 3 tornillos	OXP55 / OXV55	
OXS01		Lote 2 mangos + 5 clips / OX (antes 2019) / OX5	OXP55 / OXV55	
OX875-5		Tornillo mariposa / OX - lote de 5	OXP55 / OXV55	
OX880		Base placa para atornillar - inox - con forro de plástico	OXP55	
OX890		Soporte brida - inox - con forro de plástico	OXV55	
O2898		Tornillo inox para soporte brida con barrita blanca	OXV55	
O2879-10		Barrita blanca para tornillo de soporte brida - lote de 10	OXV55	

Familia	Ref.	Designación			
OXP55 OXV55	O2873-5	Arandela courbhane + arandela de metal - lote de 5		OXV55 / OXP55	
	O2891-5	Forro plástico / OX / OBSX - lote de 5		OXV55 / OXP55	
	M5006-10	Clip x10 / M5 / X5 / P10		OXV55 / OXP55	
	O2871-4	Tope inox de caja x4		OXV55 / OXP55	
	OX840	Manivela + mango + tornillos		OXV55 / OXP55 / OBSXP55 / OBSXV55	
O3P40 O3V40	O3895	Hoja, moleta, arandela rilsan, arandelas, herramienta de desmontaje		O3V40 / O3P40	
	O3870-5	Arandela de rilsan - lote de 5 / O3 / O5 / OX5		O3V40 / O3P40	
	O2877-5	Tornillo de hoja - lote de 5 / O2 / O3		O3V40 / O3P40	
	O2872-5	Placa - lote de 5 / O2 / O3		O3V40 / O3P40	
	ONS01	Lote 2 mangos y 2 arandelas + 5 clips		O3V40 / O3P40	
	O2880	Base placa para atornillar - epoxy		O3P40	
	O2890	Soporte brida - epoxy		O3V40	
	O2898	Tornillo inox para soporte brida con barrita blanca		O3V40	
	O2879-10	Barrita blanca para tornillo de soporte brida - lote de 10		O3V40	
	O2873-5	Arandela courbhane + arandela de metal - lote de 5		O3V40 / O3P40	
	O2820-2	Moleta Ø 36 mm - lote de 2		O3V40 / O3P40	
	O2830-5	Hoja inox - lote de 5		O3V40 / O3P40	
	M5006-10	Clip x10 / M5 / X5 / P10		O3V40 / O3P40	
	O3840	Manivela + mango + arandela + clip		O3V40 / O3P40	
	OX5P55 OX5V55	O3895	Hoja, moleta, arandela rilsan, arandelas, herramienta de desmontaje		OX5V55 / OX5P55
O3870-5		Arandela de rilsan - lote de 5 / O3 / O5 / OX5		OX5V55 / OX5P55	
OX501		Lote 2 mangos + 5 clips / OX (antes 2019) / OX5		OX5V55 / OX5P55	
OX5880		Base placa para atornillar - inox / OX5		OX5P55	
OX5890		Soporte brida - inox / OX5		OX5V55	
O2820-2		Moleta Ø 36 mm - lote de 2		OX5V55 / OX5P55	
O2830-5		Hoja inox - lote de 5		OX5V55 / OX5P55	
O2898		Tornillo inox para soporte brida con barrita blanca		OX5V55	
O2879-10		Barrita blanca para tornillo de soporte brida - lote de 10		OX5V55	
O2873-5		Arandela courbhane + arandela de metal - lote de 5		OX5V55 / OX5P55	
M5006-10		Clip x10 / M5 / X5 / P10		OX5P55	
O2871-4		Tope inox de caja x4		OX5V55 / OX5P55	
OX5840		Manivela + mango + clip		OX5V55 / OX5P55	
O5P55 O5V55		O3895	Hoja, moleta, arandela rilsan, arandelas, herramienta de desmontaje		O5V55 / O5P55
		O3870-5	Arandela de rilsan - lote de 5 / O3 / O5 / OX5		O5V55 / O5P55
	ONS01	Lote 2 mangos y 2 arandelas + 5 clips		O5V55 / O5P55	
	O2880	Base placa para atornillar - epoxy		O5P55	
	O2890	Soporte brida - epoxy		O5V55	
	O2820-2	Moleta Ø 36 mm - lote de 2		O5V55 / O5P55	
	O2830-5	Hoja inox - lote de 5		O5V55 / O5P55	
	O2898	Tornillo inox para soporte brida con barrita blanca		O5V55	
	O2879-10	Barrita blanca para tornillo de soporte brida - lote de 10		O5V55	
	O2873-5	Arandela courbhane + arandela de metal - lote de 5		O5V55 / O5P55	
	M5006-10	Clip x10 / M5 / X5 / P10		O5V55 / O5P55	
	O2871-4	Tope inox de caja x4		O5V55 / O5P55	
	O3840	Manivela + mango + arandela + clip		O5V55 / O5P55	
	OBSX	O2870-5	Arandela de rilsan - lote de 5 / O2 / OX / OBSX		OBSXV55 / OBSXP55
		OBSXS01	2 moletas + 1 herramienta de desmontaje		OBSXP55 / OBSXV55
OBSX-28066		Soporte brida inox		OBSXV55	
OBSX-28061		Base placa inox para atornillar		OBSXP55	
OXS02		Juego de 2 mangos + 3 tornillos		OXV55 / OXP55 / OX5P55 / OX5V55	
O2898		Tornillo inox para soporte brida con barrita blanca		OBSXV55	
O2879-10		Barrita blanca para tornillo de soporte brida - lote de 10		OBSXV55	
O2891-5		Forro plástico / OX / OBSX - lote de 5		OBSXP55 / OBSXV55	
OBSXS04		Rodamientos - juego de 2		OBSXP55 / OBSXV55	
OBSXS02		Kit cuchilla, tornillo de cuchilla, soporte de cuchilla		OBSXP55 / OBSXV55	
OBSXS03		Kit mecanismo de cuchilla (bloqueo superior + conector + rodamientos)		OBSXP55 / OBSXV55	
OX840		Manivela + mango + tornillos		OBSXP55 / OBSXV55	

Familia Ref. Designación



PELADOR DE MANZANAS PROFESSIONAL KALI

N4230	N6107	Eje sin fin - sin pin tridente - sin manivela / N4230	N4230
	N6113	Tornillo 6x10 - muelle plano / N4230	N4230
	N6111	Tornillo de ajuste / N4230	N4230
	N6104	Arco / N4230	N4230
	N6105	Muelle de arco / N4230	N4230
	N6114	Leva / N4230	N4230
	N6118-V	Eje sin fin - rodajas finas / N4230	N4230
	N6106	Manivela / N4230	N4230
	N6115	Muelle plano / N4230	N4230
	N6108	Pinza / N4230	N4230
	N6117	Pie - lote de 2 / N4230	N4230
	N6116	forro de plástico	N4230
	N6110	Tornillo de hoja cortadora / N4230	N4230
	N6101	Hoja cortadora y descorazonadora / N4230	N4230
	N6102	Pelador completo / N4230	N4230
N6103	Pin tridente / N4230	N4230	

CAFETERA DE BUFFET

N5308 N5312 N5316	N5308-23	Cesta filtro / N5308	N5308
	N5312-23	Cesta filtro / N5312 - N5316	N5312/N5316
	N5308-22	Tubo elevación de agua / N5308	N5308
	N5312-22	Tubo elevación de agua / N5312	N5312
	N5316-22	Tubo elevación de agua / N5316	N5316
	N5308-14	Termostato de calentamiento 88°C / N5308 / N5312 / N5316	N5308/N5312/N5316
	N5308-12	Fusible + cableado eléctrico / N5308 / N5312 / N5316	N5308/N5312/N5316
	N5308-5	Mango del tanque x2 / N5308 / N5312 / N5316	N5308/N5312/N5316
	N5308-13	Termostato de seguridad 160° C / N5308 / N5312 / N5316	N5308/N5312/N5316
	N5308-19	Grifo completo / N5308 / N5312 / N5316	N5308/N5312/N5316
	N5308-28	Interruptor on-off - N5308 / N5312 / N5316	N5308/N5312/N5316
	N5308-32	Lámparas rojo y naranja + cableado / N5308	N5308
	N5316-32	Lámparas rojo y naranja + cableado / N5312 / N5316	N5312/N5316
	N5316-30	Resistencia de mantenimiento T° + soporte / N5308 / N5312 / N5316	N5308/N5312/N5316
	N5308-33	Resistencia de calentamiento + junta silicona / N5308	N5308
	N5316-31	Resistencia de calentamiento + junta silicona / N5312 / N5316	N5312/N5316
	N5312-COUV	Tapa completa / N5312 / N5316	N5312/N5316
	N5308-COUV	Tapa completa / N5308	N5308
	N5308-31	Base completa / N5308	N5308
	N5316-33	Base completa / N5312 / N5316	N5312/N5316
	N5308-30	Indicador nivel del agua / N5308	N5308
	N5312-30	Indicador nivel del agua / N5312	N5312
	N5316-34	Indicador nivel del agua / N5316	N5316

JARRAS ISOTERMICAS

N5076 N5077 N5078	N5076-B	Tapón / N5076	N5076
	N5076-J	Junta de tapón / N5076	N5076
	N5077-B	Tapón / N5077	N5077
	N5077-J	Junta de tapón / N5077	N5077
	N5078-B	Tapón / N5078	N5078
N5084 N5085 N5089 N5088	N5084-B	Tapón / N5084 - N5085	N5084 / N5085
	N5084T	Tubo de subida / N5084 (antiguo modelo)	N5084
	N5085T	Tubo de subida / N5085	N5085
	N5088-B	Tapón / N5088 / N5089	N5088 / N5089
	N5088-BN	Tapón / N5088 - N5089 (nuevo modelo)	N5088 / N5089
	N5088-T	Tubo de subida / N5088 (antiguo modelo)	N5088
	N5088-TNM	Tubo de subida / N5088 (nuevo modelo)	N5088
N5069 N5070 N5071 N5072	N5089-TNM	Tubo de subida / N5089	N5089
	N5069-B	Tapón / N5069	N5069
	N5072-B	Tapón / N5070 / N5071 / N5072	N5070 / N5071 / N5072
	N5072-BN	Tapón / N5070 / N5071 / N5072 (nuevo modelo)	N5070 / N5071 / N5072

Familia	Ref.	Designación	
PLANCHETTA			
PLAN	PLAN-DAR-2	Vasito inox recuperadora de jugo x2	PLAN01 / PLAN02
	PLAN-PEP	Placa esmaltada agujereada 20 x 30 cm	PLAN01 / PLAN02
	PLAN-P	Pinza inox para placa esmaltada	PLAN05 / PLAN01 / PLAN02
	190CL-20	Pie antideslizante / tope - lote de 20	PLAN02
	BRU01-2	Quemador alcohol - lote de 2	PLAN01 / PLAN05 / PLAN02
	PLAN05-PEP	Placa esmaltada 15 x 30 cm / PLAN05	PLAN05
PINZA PORTA FICHAS			
N8030 N8031	N8032-10	Lote de 10 muelles + tornillos / N8030 / N8031	N8030 / N8031
CORTADOR A GAJOS PARA QUESO			
PF	PF006	Cuchilla inox 6 secciones	PF01 / PF06 / PF08
	PF008	Cuchilla inox 8 secciones	PF01 / PF06 / PF08
	PF001	Bandeja con canaleta 6 y 8 secciones (reversible)	PF01 / PF06 / PF08
	PF010	Plato base montado reversible 6/8 secciones + 2 columnas	PF01 / PF06 / PF08
EMBUTIDORAS			
N5750	N5700-B	Anillo de ajuste / N5700 / N5750	N5700 / N5750
	N5700-C	Cuba / N5700 / N5750	N5700 / N5750
	N5750-GA	Eje (largo) para manivela / N5750	N5750
	N5700-PM	Placa de metal del pulsador / N5700 / N5750	N5750
	N5750-J	Junta para N5700 / N5750	N5750
	N5750-M	Manivela / N5750	N5750
PSX	N5750-PA	Eje (pequeño) para manivela / N5750	N5750
	PSXPRO-05-CR	Cremallera / PSX05 / PSXPRO-05	PSX05
	PSXPRO-05-CUVE	Recipiente inox / PSXPRO-05 / PSX05	PSX05
	PSXPRO-08-CUVE	Recipiente inox / PSXPRO-08 / PSX08	PSX08
	PSXPRO-ENT	4 embudos / PSXPRO-05/-08/-12 PSXPRO-VE08 / PSX05/08	PSX05/PSX08
EXPRIMIDOR DE BARRA			
N4098	N4098-B	Palanca / N4098	N4098
	N4098-C	Colector de jugo plástico / N4098	N4098
	N4098-COL	Columna / N4098	N4098
	N4098-CP	Cono perforado / N4098	N4098
	N4098-CS	Cono superior / N4098	N4098
	N4098-GC	Guía colector de jugo / N4098	N4098
	N4098-L	Kit palanca / N4098	N4098
	N4098-P	Tabla soporte / N4098	N4098
	N4098-S	Base para N4098	N4098
	N4098-SB	Soporte de brazo / N4098	N4098
	N4098-SV	Soporte para vidrio / N4098	N4098
PRENSA PARA LATAS			
N8019	N8019-B	Juego de 2 topes de rodamiento (palieres bronce)	N8019
	N8019-BL	Anilla de latón (x1)	N8019
	N8019-RC	Muelle central / bloqueo de palanca	N8019
CORTADOR DE VERDURAS LE ROUET			
4100CLR	10202	Bloque de corte 2 mm	4100CLR
	10210	Bloque de corte 10 mm	4100CLR
	10211	Caja con 4 bloques de corte (2 - 4 - 7 & 10 mm)	4100CLR
	10201-3	Bloque de corte 1 mm	4100CLR
	4051-1	Manivela (eje redondo)	4100CLR
	4141	Disco con picos	4100CLR
	4148	Cuchilla recta + tornillo + llave	4100CLR
	4056-3	Cuchilla vaciadora central (x3ud.) + herramienta	4100CLR
	GX016-12	Ventosa y anillo - lote de 12	4100CLR
	10213	Caja con 3 bloques de corte (1 - 2 & 4 mm)	4100CLR

Familia	Ref.	Designación		
4100CLR	10204	Bloque de corte 4 mm		4100CLR
	10207	Bloque de corte 7 mm		4100CLR
	4150	Carro completo		4100CLR
4030CLR	4051-1	Manivela (eje redondo)		4030CLR
	4141	Disco con picos		4030CLR
	4056-3	Cuchilla vaciadora central (x3ud.) + herramienta		4030CLR
	GX016-12	Ventosa y anillo - lote de 12		4030CLR
	4043	Bloque de corte 2 mm		4030CLR
	4044	Bloque de corte 3 mm		4030CLR
	4045	Bloque de corte 6 mm		4030CLR
	4054	Carro completo		4030CLR

SIFON DE CREMA Y AGUA

N4083X N4084X N4086X N4087X N4075X	NK752	Cepillo / adaptator / boquilla recta y tulipán / N4086X / N4087X	N4086X/N4087X	
	NK738	Portacartuchos + capuchón / N4086X / N4087X / N4075X	N4086X/N4087X/N4075X	
	NK5134	Válvula / N4086X / N4087X	N4086X/N4087X	
	NK750-3	Junta de la cabeza - lote de 3 / N4086X / N4087X / N4083X / N4084X	N4086X/N4087X/N4083X/N4084X	
	NK755	Cabeza completa / N4086X / N4087X	N4086X/N4087X	
	NK652	Cepillo / adaptator / boquilla recta y tulipán / N4086X / N4087X	N4086X/N4087X	
	NK638	Portacartuchos + capuchón / N4086X / N4087X / N4075X	N4086X/N4087X	
	NK513A	Válvula / N4086X / N4087X	N4086X/N4087X	
	NK785	Cabeza completa / N4086X / N4087X	N4086X/N4087X	
	NK401	Llave + tubo de medida + tubo y junta / N4075X	N4075X	
	NK774	Cabeza completa / N4086X / N4087X	N4075X	
	YC80105	YC80105-21	Portacartuchos + capuchón / N4086X / N4087X / N4075X	YC80105
		YC80105-22	Kit : cepillo / adaptator / boquilla recta x2 y tulipán / YC80105	YC80105
YC80105-23		Junta de la cabeza - lote de 3 / N4086X / N4087X / N4083X / N4084X	YC80105	
YC80105-24		Válvula / N4086X / N4087X	YC80105	

PAPAS FRITAS EN ESPIRAL

CNX	GX017-4	Pie de acero inox corto - lote de 4	CNX225
	GX016-12	Ventosa y anillo - lote de 12	CNX225
	4141	Disco con picos	CNX225 / CNX225-V
	N6116	Forro de plástico	CNX225 / CNX225-V
	CNX225-L	Cuchilla de corte 2,25 mm	CNX225 / CNX225-V
	CNX450-L	Cuchilla de corte 4,5 mm	CNX225 / CNX225-V
	O2898	Tornillo inox para soporte brida con barrita blanca	CNX225-V
	O2879-10	Barrita blanca para tornillo de soporte brida - lote de 10	CNX225-V

CORTARODAJAS «EXPRESS»

TAT	TAT01	Cuchilla inox de repuesto	TAT
	TAT02-5	Tornillos violín x10	TAT
	190CL-20	Pie antideslizante / tope - lote de 20	TAT
	TAT03	Empujador PEHD	TAT
	CTXM07	Mango + 2 tornillos	TAT

SACABOCADOS TURN'UP

TU	107TU	Protección para cuchilla redonda	TU01
	108TU	Protección para cuchilla plana	TU01 / TU02
	102TU	Cuchilla plana inox + atornillado	TU01
	101TU	Cabeza portacuchilla plana - PE	TU01
	103TU	Eje eyector - PE	TU01 / TU02
	104TU	Portatubos / cuchilla redonda con pasadores	TU01 / TU03
	105TU	Gran cuchilla redonda de acero inoxidable	TU01
	205TU	Gran cuchilla redonda (TU02) - pequeña cuchilla redonda (TU01) - inox	TU01 / TU02
	207TU	Protección para cuchilla redonda	TU02
	202TU	Cuchilla plana inox + atornillado	TU02
	201TU	Cabeza portacuchilla plana - PE	TU02
	204TU	Portatubos / cuchilla redonda con pasadores	TU02
	206TU	Pequeña cuchilla redonda - inox	TU02
	303TU	Eje eyector - PE	TU03

Familia	Ref.	Designación		
TU	305TU	Gran cuchilla redonda de acero inoxidable		TU03
	308TU	Pequeña cuchilla redonda - inox		TU03
	306TU	Pequeña espátula para cortar		TU03
	307TU	Protección para cuchilla redonda		TU03
	5020-5	Bola negra sola - lote del 5		TU03

DIVERSOS

OEXT2	R010	Pequeño piñon plástico para motor / OEXT2		OEXT2
N4212	N4212-PV	Pie ventosa / N4212		N4212
N8090 N8091	N8091-C	Tapa para N8091		N8091
	N8090-R	Resistencia de calentamiento / N8090 / N8091		N8090 / N8091
	N8091-1	Grifo para N8091		N8091
N8110	N8110-C	Tapa / N8110		N8110
CTE00	CTE01	5 cuchillas para corte de estrellas CTE00		CTE00

LOUIS TELLIER SAS

116 Quai de Bezons - 95100 ARGENTEUIL (Francia)

Tel.: +33 134 113 838 – Fax : +33 134 111 850

Sociedad Limitada Simplificada (S.A.S.) con un capital social de 6 360 000 €

Inscrita en el Registro Mercantil de Pontoise con el n.º 49 259 93 86

CONDICIONES GENERALES DE VENTA**En vigor a partir del 1 de enero de 2022**

La realización de un pedido implica la aceptación sin reservas por parte del comprador de las presentes condiciones de venta y de la cláusula de reserva de propiedad. Todas las negociaciones comerciales se basan exclusivamente en las presentes condiciones de venta.

1. OBJETO:

Las presentes condiciones de venta son aplicables a los compradores que distribuyen e instalan equipos para usuarios finales de HORECA (comercio asociado con alimentación humana, bares, restaurantes y hoteles), así como a distribuidores que realizan ventas directas a usuarios finales no profesionales para uso privado con respecto a la venta de colecciones de Tellier Gobel et Cie S.A.S., que integra las marcas LT Louis Tellier, Gobel, Broncoucke, Yoocook y La Bonne Graine.

2. ACEPTACIÓN DE PEDIDOS:

Todos los pedidos se registran sin compromiso con respecto a la entrega. Los precios se comunicarán en un documento adjunto a las condiciones generales de venta. Dado que Tellier Gobel et Cie (TG&C) cuenta con una red de distribución diversificada, las reducciones de precio serán estipuladas por Tellier Gobel et Cie en condiciones de venta específicas por categoría atendiendo a categorías específicas de compradores. De conformidad con el artículo L441-6 del Código de Comercio francés, Tellier Gobel et Cie enviará sus precios a los compradores de la misma categoría junto con las condiciones generales de venta y las condiciones de venta específicas por categoría. Los precios, las condiciones generales de venta y las condiciones de venta específicas por categoría constituirán, como parte integrante de un todo indivisible, la única base de las negociaciones comerciales que se mantengan. Todos los pedidos se registrarán por las condiciones generales de venta y las condiciones de venta específicas por categoría en vigor en la fecha en la que el comprador efectúe el pedido. Con respecto a la diversidad de nuestra red, todos los pedidos deberán ser aceptados y comunicados por Tellier Gobel et Cie S.A.S. Todas las cancelaciones (independientemente de los pedidos atrasados) deberán ser aceptadas por escrito por Tellier Gobel et Cie. Los artículos y embalajes específicos no podrán cancelarse en el caso de que haya comenzado su fabricación o se haya adquirido el material necesario para esta.

3. PESO Y DIMENSIONES:

Todos los pesos y dimensiones indicados en el catálogo tienen un margen de precisión de +/- 5%. No se aceptarán quejas relativas a una desviación inferior a dicho margen.

4. FLETE Y ENTREGAS PARCIALES:

Los envíos a Francia metropolitana se efectuarán franco de porte para entregas de un valor neto de un mínimo de 450 € (IVA no incluido). Si no estuviera disponible algún artículo que implique una modificación en el precio, no podrá entregarse franco de porte el resto del pedido con un valor neto inferior a 200 € (IVA no incluido).

Para pedidos inferiores a 450 € antes de impuestos, se aplicará un coste de porte:

-15 € (IVA no incluido) para pedidos inferiores a 150 € (IVA no incluido)

-20 € (IVA no incluido) para pedidos inferiores a 300 € (IVA no incluido)

-25 € (IVA no incluido) para pedidos inferiores a 450 € (IVA no incluido)

Los envíos a países extranjeros, los departamentos y territorios de ultramar franceses y Córcega parten desde Jouvés-Tours en condiciones EXW. El Incoterm de 2020 FCA frontera francesa podrá utilizarse como condiciones de entrega de Francia conforme a lo anterior.

TG&C S.A.S. está autorizado a efectuar entregas tanto completas como parciales. Todas las entregas parciales deberán considerarse contratos independientes y, en consecuencia, el comprador no podrá aludir al hecho de que está esperando el resto del pedido para retrasar el pago de la entrega parcial efectuada.

5. ENVÍO E INSPECCIÓN DE LA ENTREGA:

Los productos y su embalaje se transportan siempre a riesgo del comprador, incluso cuando se vendan a portes pagados. Por tanto, el comprador, cuando corresponda, tiene la obligación de proteger sus derechos frente a los transportistas de conformidad con los artículos L133-3 et seq. del Código de Comercio francés, donde se estipula lo siguiente:

«A la recepción de los artículos transportados se extinguirá el derecho a reclamar al transportista por daños o pérdida parcial si, en un plazo de tres días tras la recepción, sin incluir días festivos, el destinatario no ha comunicado al transportista una reclamación fundamentada mediante medios extrajudiciales o correo certificado».

El comprador deberá hacer constar por escrito de forma precisa y fundamentada cualquier reserva con respecto a la recepción del transportista, en cuyo caso deberá informar a TG&C de inmediato. Sin perjuicio de las acciones emprendidas contra el transportista, las reclamaciones sobre defectos aparentes, ausencia de productos o no conformidad de los productos entregados con respecto a los pedidos o el albarán de entrega deberán efectuarse por escrito en un plazo de 15 días naturales tras su recepción. TG&C no atenderá las reclamaciones efectuadas con posterioridad a dicho plazo.

Corresponde al comprador proporcionar pruebas de los defectos o anomalías que se descubran. Deberá permitir en todo momento a TG&C o su representante observar dichos defectos y subsanarlos. El comprador se abstendrá de actuar por sí mismo o de hacer que un tercero actúe para tal fin. En caso de defectos aparentes, productos faltantes o daño, demostrado de dicha forma, la responsabilidad de TG&C se limita de forma estricta a una obligación de reemplazar dichos productos, con exclusión de daños y perjuicios. Se indican plazos de entrega únicamente para fines informativos, aunque no pueden garantizarse en modo alguno. El comprador no podrá aludir al retraso en una entrega para cancelar el pedido en modo alguno ni rechazar productos en caso de entrega parcial o como motivo para reclamar daños y perjuicios. Las entregas se efectuarán de conformidad con la disponibilidad y en el orden en que se reciban los pedidos.

6. PRECIOS:

Los precios de los bienes son los que están en vigor en la fecha de entrega acordada. Se indican en euros (€) sin incluir el IVA para productos envasados. Por tanto, deberá añadirse el tipo de IVA actual, la ecotasa* (impuesto francés al reciclaje) o la aportación

medioambiental***, según corresponda, así como los costes de transporte aplicables en la fecha de pedido.

TG&C S.A.S. tiene derecho a modificar su lista de precios en cualquier momento comunicándolo con una antelación de 30 días. Cuando deba modificarse un precio entre la fecha de registro de un pedido y su entrega, TG&C se compromete a informar al comprador. El embalaje y la presentación a la que se hace referencia en la lista de precios se indican únicamente para fines informativos. Nos reservamos el derecho a modificar el embalaje y la presentación con respecto a nuestros productos. Cualquier embalaje o presentación específica se facturará de forma adicional.

7. REBAJAS Y DESCUENTOS:

Los precios que aparecen en la lista de precios se indican en bruto. Los distribuidores comerciales, instaladores y vendedores al por menor se benefician de un descuento habitual, confirmado por una carta de condiciones especiales y el contrato correspondiente, para el cual se tendrán en cuenta la contratación por parte del comprador de determinados servicios. No se aplicará ningún descuento por pronto pago.

8. INTERNET:

Si el comprador distribuye o presenta en Internet productos de TG&C, dichas actividades deben efectuarse estrictamente dentro del ámbito de aplicación de las presentes condiciones generales de venta y cumplir los reglamentos sobre distribución de productos de TG&C en Internet, que TG&C le facilitará previa solicitud. En consecuencia, el comprador informará a TG&C de todas las ventas de sus productos que se efectúen por Internet. Deberá firmarse un contrato especial mediante el cual se permita al comprador realizar ventas de productos de TG&C a un tercero mediante distribución online.

Todas las actividades promocionales online relativas a productos de TG&C deben ser aprobadas por TG&C S.A.S.

9. CONDICIONES DE PAGO:

(Artículos L.441-6 y D.441-5 del Código de Comercio francés, Ley francesa n.º 2001-420 de 15/05/2001 y Directiva Europea n.º 2000/35 CE de 29/06/2000).

Los pedidos iniciales son pagaderos por adelantado según factura proforma o pago contra reembolso mediante transferencia bancaria SEPA o giro bancario. Tras la apertura de una cuenta confirmada por nuestro departamento financiero, nuestras facturas son pagaderas a 30 días desde final de mes mediante adeudos domiciliados de la SEPA o letras de cambio directas.

En caso de impago del precio total o parcial de los artículos tras la fecha de vencimiento indicada en la factura, el comprador deberá abonar a TG&C intereses de demora correspondientes al triple del tipo de interés oficial, el cual consistirá en el tipo de interés oficial en vigor en la fecha de mora. Dicha multa se basará en el total, IVA incluido, de la suma pendiente y será aplicable a partir de la fecha de vencimiento sin necesidad de efectuar ningún requerimiento de pago formal. En caso de retraso en el pago, y de forma adicional a los intereses de demora, se aplicará una indemnización fija por gastos de cobro de 40 €. Si dichos gastos exceden el importe de 40 €, se podrán facturar previa presentación de los justificantes oportunos.

10. RESCISIÓN:

Nos reservamos formalmente el derecho a rescindir la tramitación de pedidos en caso de impago, incluso de un solo vencimiento, independientemente de los impedimentos o el motivo, sin que dicha rescisión impida a TG&C hacer valer sus derechos en virtud de su cláusula de reserva de propiedad.

11. RESERVA DE PROPIEDAD:

De conformidad con la Ley francesa de 25/01/1985, modificada por la Ley de 01/07/1996, TELLIER S.A.S. conserva la propiedad de los bienes vendidos hasta el pago íntegro del precio, tanto el principal como los intereses. A este respecto, si el comprador es objeto de concurso o liquidación judicial, TG&C S.A.S. se reserva el derecho a reclamar, en el marco del procedimiento concursal, las mercancías vendidas y pendientes de pago. Como condición esencial y determinante de las presentes condiciones generales de venta, todas las ventas de productos efectuadas al comprador están supeditadas a una cláusula de reserva de propiedad. Por consiguiente, los productos entregados seguirán siendo propiedad de TG&C S.A.S. hasta que se efectúe el pago íntegro del precio y los intereses que puedan corresponder. El impago de algún importe en la fecha de vencimiento puede dar lugar a la reclamación de los bienes en cuestión. El término «pago» se entiende como la recepción efectiva por parte de TG&C S.A.S. de todas las sumas debidas.

12. DEVOLUCIÓN DE MERCANCÍA:

No se acepta ninguna devolución sin el acuerdo previo y por escrito de TG&C S.A.S. Toda solicitud de devolución debe efectuarse por escrito. No se acepta ninguna devolución a portes debidos. Para poder aceptar una mercancía, esta debe:

- devolverse en su embalaje original.

- no haber sido utilizada.

- estar en perfecto estado.

- incluir todos los documentos proporcionados (comunicaciones, etc.).

Los gastos del transporte de devolución corren a cargo del cliente. No se admite la devolución de pedidos especiales. No se admite la devolución ni el cambio de los artículos de madera (tablas para cortar, espátulas, etc.). En toda devolución o recuperación a demanda del cliente, se aplica una deducción del 25 % en concepto de gastos de gestión. No se tendrá en consideración ningún coste de reparación, independientemente del motivo de la devolución.

13. GARANTÍAS LEGALES:

De conformidad con la carta profesional de SYNEG, la disponibilidad de piezas de repuesto que prevenimos para un producto susceptible de reparación fabricado en nuestras instalaciones es de 10 años desde su fecha de lanzamiento. El servicio postventa de TG&C S.A.S. realiza vistas detalladas de los productos disponibles para los distribuidores y usuarios a fin de garantizar el mantenimiento de los dispositivos. El servicio postventa de TG&C S.A.S. efectúa determinados procedimientos de recalibración a disposición de distribuidores y usuarios, en particular relativos a escalas profesionales, a fin de facilitar la reparación de dispositivos por parte del usuario o del distribuidor.

Los productos de Tellier Gobel et Cie S.A.S. vendidos en Francia están garantizados frente a defectos de fabricación o de los materiales, previa presentación del justificante correspondiente, durante 2 años desde la fecha de compra. En caso de un periodo superior indicado en el embalaje, prevalece el plazo mencionado en el folleto o el embalaje oportuno.

La presente garantía excluye artículos frágiles fabricados en madera, cerámica o cristal, así como electrodomésticos, utilizados en el transcurso de una actividad profesional. Una vez transcurrido dicho periodo, los productos pueden ser reparados en nuestro taller de servicio postventa de Argenteuil tras la elaboración del presupuesto correspondiente por parte de nuestro servicio postventa.

La garantía se aplica, a excepción de las piezas sujetas a desgaste como hojas, ruedas, etc. o consumibles, en condiciones normales de uso y mantenimiento. No incluye el uso y desgaste normal del producto. La presente garantía no cubre ningún daño que sea resultado de:

- golpes, caídas, impactos, sobrecarga,
- mal uso, negligencia, incumplimiento de las instrucciones de funcionamiento, error en la puesta en funcionamiento, limpieza o mantenimiento.
- uso de piezas de repuesto o accesorios no compatibles, o modificación o reparación no autorizada.

Asimismo, quedan excluidos los casos siguientes:

- sobrecalentamiento, exposición prolongada a la llama o limpieza en vacío
- manchas interiores o exteriores, decoloración o arañazos
- cualquier tipo de accidente relacionado con fuego, inundación, rayos, etc.
- daño directo o indirecto debido a mareas tormentosas o trabajos en redes eléctricas
- entrada de líquido en partes eléctricas
- inmersión de un producto no adaptado, entrada de polvo o de insectos en el producto,
- utilización de agua o consumibles no adecuados
- calcificación (todo proceso de descalcificación debe efectuarse de conformidad con las instrucciones indicadas en el manual de uso)
- daños o problemas de funcionamiento debidos específicamente a la utilización de un voltaje o frecuencia eléctrica no conformes a los especificados en la placa de características.

La capa antiadherente de los moldes Gobel, sin bisfenol A, está garantizada durante 2 años de uso profesional frente a la formación de ampollas o desprendimiento, excepto para el uso del procedimiento de baño maría, la limpieza en lavavajillas, o bien el uso sobre llama directa o a una temperatura superior a 250° C. Todos los productos fabricados a partir del 1 de enero de 2016 incluyen la trazabilidad del lote del material utilizado y la fecha de fabricación. Los moldes de hojalata y los aparatos no están garantizados frente a la oxidación y deben secarse tras su lavado a mano. Los artículos de aluminio no están garantizados frente a manchas u oxidación como resultado de su uso al baño maría o lavado en un lavavajillas.

La presente garantía no es aplicable a los problemas de embalaje o transporte durante el envío del producto por parte del propietario o distribuidor. Las garantías de los productos de las marcas pertenecientes a la empresa Tellier Gobel et Cie S.A.S. no afectan a los derechos legales que asisten a un consumidor a nivel local (en Francia la garantía legal de conformidad a la que se hace referencia en los artículos L211-4, L211-5 y L221-12 del Código de Consumo, así como las garantías legales frente a defectos ocultos que se recogen en los artículos del 1641 al 1649 del Código Civil), los cuales no pueden excluirse ni limitarse, ni tampoco a los derechos legales frente a un distribuidor al que se ha adquirido un producto.

Tellier Gobel et Cie S.A.S. no se hace responsable de la descripción deficiente de sus productos por parte del distribuidor.

Modalidades:

Toda devolución para el cambio o reparación de un producto sujeta a la presente garantía requiere el consentimiento previo por escrito de Tellier Gobel et Cie S.A.S., la comunicación por parte del Departamento de Administración de Ventas de un número de referencia del servicio postventa y la cumplimentación del formulario correspondiente.

La mercancía devuelta será aceptada siempre y cuando:

- se encuentre en su embalaje original,
- incluya todos los documentos facilitados (instrucciones, etc.)
- se facilite el número de referencia y el formulario de devolución del servicio postventa

Los costes del transporte de devolución corren a cargo del cliente.

14. TRATAMIENTO DE LOS RAEE

(residuos de aparatos eléctricos y electrónicos).

Disposición aplicable en Francia metropolitana y los departamentos y territorios de ultramar:

De conformidad con el Decreto n.º 2005-829 de 20/07/2005 relativo a los RAEE, completado por el Decreto n.º 2012 – 617 de 02/05/2012 y el Decreto n.º 2014 – 928 de 23/08/2014, TELLIER S.A.S. está inscrita en el registro nacional francés de fabricantes de aparatos eléctricos y electrónicos (ADEME).

* RAEE denominados «domésticos»:

De acuerdo con la evolución de la legislación, los pequeños aparatos eléctricos y electrónicos que pueden utilizarse también en el hogar estarán regulados por la legislación de los RAEE domésticos a partir del 01/01/2015, incluso en el marco de la venta entre profesionales: orden de 8 de octubre de 2014 que modifica la orden de 13 de julio de 2006 en aplicación del artículo 2 del decreto n.º 2005-829 de 20 de julio de 2005 relativo a la composición de los aparatos eléctricos y electrónicos y a la eliminación de los residuos procedentes de ellos: «Sin perjuicio del artículo L2224-14 del código general de las entidades territoriales, los residuos de aparatos eléctricos y electrónicos de origen comercial, industrial, institucional y otros que, debido a su naturaleza y cantidad, son similares a los domésticos, y los residuos procedentes de aparatos eléctricos y electrónicos que puedan ser utilizados al mismo tiempo por los usuarios domésticos y no domésticos que pertenezcan, hasta el 14 de agosto de 2018, a otra categoría distinta de las categorías 5 y 11 del artículo R. 543-172-II del código de medio ambiente y, a partir del 15 de agosto de 2018, a otra categoría distinta de las categorías 3 y 7 del artículo R. 543-172-II del código de medio ambiente, se consideran residuos de aparatos eléctricos y electrónicos domésticos en el sentido del artículo R. 543-173 del Código de Medio

Ambiente, a partir del 1 de enero de 2015»

El distribuidor está obligado a recoger o hacer recoger de forma gratuita el aparato usado entregado por el usuario durante la compra de un aparato nuevo. El distribuidor también está obligado a informar a los consumidores del coste de gestión de los RAEE, mostrando el importe de la aportación que debe figurar de forma clara en la factura de venta. Las aportaciones en materia de RAEE de los aparatos pequeños que figuran en esta lista de precios corresponden al baremo en vigor del organismo medioambiental a fecha 01/01/2015, que puede variar durante el año. Le recomendamos que esté atento a las modificaciones efectuadas en los baremos e importes indicados en las facturas. El pago de la aportación medioambiental correspondiente por el distribuidor y el usuario permite que el organismo medioambiental se haga cargo de los AEE al final de su vida útil una vez el usuario entregue el aparato en un punto de recogida o mediante su recogida (a cargo del usuario en caso de volumen inferior a 500 kg o 2,5 m³).

** RAEE denominados «profesionales»:

VALORESTOPRO, gestionada por el organismo medioambiental Ecologic, se encarga en nombre de Tellier S.A.S. de la recogida y el reciclaje de los RAEE dedicados a un uso exclusivamente profesional (p. ej., abrellas eléctrico, molinillos eléctricos). Ecologic también gestiona todos los requisitos administrativos y reglamentarios (albarán de seguimiento de residuos, certificación de destrucción, etc.). El propietario de un AEE profesional al final de su vida útil, ya sea vendedor, instalador o usuario, debe ponerse en contacto con el organismo medioambiental Ecologic: por Internet en www.e-dechet.com o por contacto telefónico en el número +33 (0) 1 30 57 79 14, para organizar su tratamiento tras la entrega por parte del propietario en un punto de recogida Ecologic o mediante su recogida (a cargo del propietario en caso de volumen inferior a 500 kg o 2.5 m³).

El distribuidor está obligado a informar, por todos los medios adecuados, a los usuarios y propietarios de AEE profesionales de las opciones de recogida y tratamiento de los RAEE implantados por Tellier S.A.S. (artículo R. 543-195 III del Código de Medio Ambiente francés). Un usuario o un propietario que se deshace de un AEE profesional y que no desea hacer uso de los servicios de recogida y tratamiento implantados está obligado a comunicar a la ADEME y al fabricante del AEE la información necesaria para la observación y el tratamiento de dichos RAEE. (Decreto n.º 2014-928 de 19 de agosto de 2014 – artículo R. 543-199). Los costes de gestión de los AEE profesionales son objeto de una aportación medioambiental, la cual se indica en la presente lista de precios.

15. FUERZA MAYOR:

Tellier Gobel et Cie S.A.S. no será responsable del incumplimiento o el retraso en la ejecución de alguna de sus obligaciones, descritas en las presentes condiciones generales de venta, debido a una causa de fuerza mayor. A este respecto, se entiende por causa de fuerza mayor cualquier acontecimiento externo, imprevisible e incontrolable en el sentido del artículo 1148 del Código Civil francés.

16. COMPETENCIA:

El contrato de venta se rige por la legislación francesa. Cuando no pueda llegarse a un acuerdo amistoso, todas las controversias relativas a la presente venta, incluso en caso de una reclamación en virtud de la garantía o pluralidad de demandados, serán competencia exclusiva del tribunal con jurisdicción territorial en el lugar donde esté ubicada la dirección a efectos de notificaciones de Tellier Gobel et Cie S.A.S. Por tanto, las controversias serán competencia del Tribunal de Comercio de Pontoise (FRANCIA).

«		Aro de tarta - Alto borde redondo	246	Bandeja para pan «baguette» x2 perforada	184
«Manqué» cuadrado	199,236	Aro de tarta borde redondo	233,246	Bandeja para pan «ficelle»	184
«Manqué» desmontable	199,235	Aro mousse A40	249	Bandeja para pan de mini-hamburguesas	184
«Manqué» reondondo acanalada	199,235	Aro mousse A45	250	Bandeja para pizza	186,225
«Manqué» Roseta	198,235	Aro mousse duo	250	Bandeja para pizza perforada con pies	186,225
«Petits-fours»	204	Aro mousse tres Lágrimas	250	Bandeja perforada para 2 «baguettes» Obsidian	215
«Petits-fours» - Barco Calisson	239	Aro para postre A35	249	Bandeja rectangular adicional	143
«Petits-fours» - Barquitas lisa	239	Aro para tarta borde - Cuadrado	247	Baño maría y dispensador de salsas	120
«Petits-fours» - Cuadrado acanalado	239	Aro para tarta borde - Rectangular	247	Baño maría cocción al vacío - SousVide Supreme™	119
«Petits-fours» - Cupula ovalada rizada	239	Aro Redondo	252	Barquita acanalada	205,239
«Petits-fours» - Cúpula redonda acanalada	239	Aro Redondo A50	249	Barquita lisa	204,239
«Petits-fours» - Ovalado acanalada	239	Aro Redondo ajustable	249	Barreño de fondo plano	272
«Petits-fours» - Rectangulo liso	239	Aro Redondo Vacherin	251	Batidor de bola para claras	275
«Petits-fours» - Redondo hueco	239	B		Batidor profesional	275
«Petits-fours» - Rombo liso	239	Badeja para pastelería	267	Batidor profesional ergonómico - Alta Calidad - Patentado	275
«Petits-fours» - Tartaleta redonda lisa	239	Badeja para pastelería - Perforada	268	Bicicleta cortadora ajustable	284
1, 2, 3...		Badeja para pastelería - Perforada - Sin bordes	268	Bicicleta cortadora ajustable - divisor de pasta	284
18 herramientas de decoración + piedra afiladora	61	Badeja para pastelería con bordes rectos	267	Blíster de 4 moldes ovalados con fondo liso	205
5 cuchillas para Cortador-Estrellas CTE00	61	Balanza de precisión	107	Blister de decoración	280,281
A		Balanza electrónica	107	Bloc de notas (rollo)	144
Abrelatas eléctrico para colectividades	97	Balanza electrónica profesional	107	Bloque cuchillas para mandolina	23
Abrelatas eléctrico profesional	97	Balanza electrónica profesional con columna	107	Bloque de corte	53
Abrelatas manual	101	Balanza electrónica profesional compacta	107	Bol de fondo redondo	272
Abrelatas manual - NF Higiene alimentaria	101	Balanza electrónica uso doméstico	108	Bol semi-esférico	272
Abrelatas manual de seguridad «PALM»	104	Balanza mecánica	108	Bol semi-esférico con base antideslizante	272
Abrelatas primer precio	104	Bandeja Flaneros	211	Bol semi-esférico con tapadera que sirve de base	272
Abrelatas profesional	102	Bandeja 12 mini tartaletas	182	Bola para té y especias	132
Abrelatas profesional LT original	102	Bandeja adicional redonda	143	Bolas para bandeja giratoria	97
Abrelatas seguridad sin bordes cortantes	101	Bandeja con rejilla	94	Bolsas al vacío gofradas	149
Abrelatas TITAN semi-profesional	103	Bandeja de 12 magdalenas	181,223	Bolsas para envasar al vacío SousVide Supreme™	119
Abridor con caja de recuperación	130	Bandeja de 12 magdalenas OBSIDIAN	215	Boquilla «Saint Honoré»	279
Abridor de huevos	81	Bandeja de 20 mini magdalenas	181,223	Boquilla Avellana	278
Accesorio «Reblochade» para máquina Alpage®	166	Bandeja de 20 mini magdalenas OBSIDIAN	215	Boquilla moca	278
Accesorio «Reblochonnade» + Raclette para Brézière®	166	Bandeja de Canelés Bordelés	211	Boquilla para rellenar	278
Accesorio «Reblochonnade» para máquina Brézière®	166	Bandeja de financieros	210	Boquilla redonda	278,279
Accesorio máquina de pasta IMPERIA	72	Bandeja de magdalenas	209	Boquilla tronco	278
Accesorio motorizables para N7905-E	73	Bandeja de manqués	209	Boquilla unida	278
Accesorio para máquina de pasta Atlas 150	70	Bandeja de millasson	209	Boquillas para especialidades	279
Accesorio para salsa de tomate para picadora	65	Bandeja de moldes ovalados	210	Brasero	171
Accesorio para salsa de tomate para picadora HV5-EL	65	Bandeja de muffins	210	Brasero - BBQ de la mesa	171
Accesorio Pasta 150	73	Bandeja de panes hamburguesa	211	Brasero - Combinados BBQ - Reblochade	171
Accesorio ravioli para N8001 / N8005 / N7994	69	Bandeja de pequeñas magdalenas	209	Brioche - 10 costados	228
Accesorios para deshidratadores	151	Bandeja de Savarin	211	Brioche - 9 costados	228
Adaptador para Balanza electrónica	108	Bandeja giratoria para latas redondas	97	Brioche grande - Grandes costados	189,228
Afilador de cuchillos	90	Bandeja japonesa con rejilla	94	Brioche pequeña - 10 costados	189
Ahumadero en frío	176	Bandeja para 12 mini barquitas	182	Brioche pequeña - 9 costados	189
Ahumadero frío	176	Bandeja para 2 «baguettes» Obsidian	215	Brocha de Seda Mango de Haya	277
Alligator cortadores multiusos	41	Bandeja para 2 pans	184	Brocha de silicona	277
Antorcha soplete profesional	293	Bandeja para 6 financieros Obsidian	215	Brocheta gigante	176
Aparato de Raclette	165	Bandeja para 6 magdalenas - antiadherente	181	Brocheta medieval estilo espada	176
Aparetos de Raclette Profesional	168	Bandeja para 6 magdalenas - antiadherente Obsidian	215	Brochetas para máquina de raclette Alpage®	166
Arandela courbane	98	Bandeja para 6 magdalenas - hojalata	223	C	
Arandela de rilsan (Para 03 / 05 /OX5)	103	Bandeja para 8 «Éclairs»	181	Caballote porta-recetas bandeja barquitas	298
		Bandeja para financieros	181,223	Caballote porta-recetas de pan casero	298
		Bandeja para Hoja de galletas redondeada	182	Cabezal pelador completo	48
		Bandeja para mini financieros	182,223	Cable de conexión «Le convivial»	168
		Bandeja para pan «baguette»	184		
		Bandeja para pan «baguette» x2	184		

Cafetera de buffet	133	Conjunto bandeja y cubetas japonesas	153	Cuchara de haya	91
Caja cristal de 6 boquillas	279,280	Conjunto de 6 aros mousse	250	Cuchara de resina sintética	92
Caja de 30 moldes «petit four»	239	Conjunto de embudos para picadora manual N4032C	66	Cuchara de silicona	275
Caja de 4 aros con empujador	249	Corredera parac Corta-patatas profesional	29	Cuchara para cóctel	131
Caja de 4 aros de tarta	246	Corta lechuga	34	Cucharón profesional	93
Caja de 4 Moldes «Soufflé» - Individual	202	Corta lechuga compacto	34	Cuchilla + empujador de corta patatas - Compact pro	28
Caja de 4 moldes para panes hamburguesas	185	Corta piñas	58	cuchilla Alligator Original 12 x 12 mm	41
Caja de 4 raros cuadrados con empujador	252	Corta sandías	59	Cuchilla para Corta-patatas	29
Caja de 4 rectangulares con empujador	253	Corta tomates en secciones, versión alta	33	Cuchilla para cortador a gajos	53
Caja de 6 aros galleta	246	Corta tomates en secciones, versión baja	33	Cuchilla para cortador de manzanas a gajos	53
Caja de 6 flaneros acanalados «Bordelais»	206	Corta tortilla	83	Cuchilla para cortador de melón	59
Caja de 6 moldes para muffin	205	Corta-Patatas - Compact Pro	28	Cuchilla para mandolina japonesa	25
Caja de 6 moldes para muffin - OBSIDIAN	218	Corta-patatas atornillar	27	Cuchilla para Pelador de piñas	57
Caja de 6 Pastéis de Nata	240	Corta-patatas base inox	27	Cuchilla para picadora manual	66
Caja de 6 Savarines individuales	201	Corta-patatas base metal Epoxy	27	Cuchilla para picadora manual N4032C	66
Caja de 8 cortapasrtas Redondos acanalados	286	Corta-patatas de pared	28	Cuchilla trinchante basculante	42
Caja de 8 cortapasrtas Redondos lisos	286	Corta-patatas doméstico	28	Cuchillas para corta lechuga	34
Caja de especias	153	Corta-patatas HACCP	28	Cuchillo especial Raclette	167
Caja dispensadora para mascarar desechables	159	Corta-patatas Sobre Pie Alto	27	Cuchillo para Alligator	42
Caja distribuidora para bolsas de plástico	150	Cortabaguet	83	Cuchillo para corta lechuga	34
Caja japonesa	154	Cortador a gajos	53	Cuchillo para papas fritas en espiral	30
Caja redonda de 6 boquillas	280,281	Cortador a gajos para queso	78	Cuchillo para picadora N5600	64
Cajas dispensadoras para charlottes desechables	160	Cortador Alligator Original	41	Cuchillo Thai	61
Cajas dispensadoras para gorras de papel desechables	159	Cortador Alligator Original 6x6cm	41	Cuentas para massa de tartas	294
Cajas dispensadoras para gorros redondos	159	Cortador de 1/2 de rodajas de limón	53		
Cajas dispensadoras para guantes desechables	159	Cortador de 1/2 o 1/4 de rodajas de limón	53	D	
Cajas dispensadoras para kit visitantes	160	Cortador de 1/4 de rodajas de limón	53	Decoradores espiral	63
Cajas y lotes de cortadores	286	Cortador de cebolla y tomate Alligator Original	41	Densímetro pesa jarabe	112
Calentador de agua y grifo	133	Cortador de coco	58	DesCorazónador de piña	58
Calientaplatos «trapecio»	141	Cortador de huevos - Rodajas	81	Deshidratador de frutas y verduras	151
Calientaplatos con vela	141	Cortador de huevos en secciones	81	Deshidratador de frutas y verduras programable	151
Calisson	287	Cortador de manzanas	54	Dispensador de papel	150
Campanilla de barra	132	Cortador de pan	83	Dispensador de salsas para restauración colectiva	141
Canasta de huevos	119	Cortador de pepinillos	62	Dispensador higienizante de pared	159
Carro Protector	24	Cortador de queso y foie gras con hilo y bandeja	78	Dispensador higienizante de pie con pedal, inox	159
Carro snacking	141	Cortador de rábano	62	Dispensador para film transparente y aluminio	150
Cedazo 1 pieza	289	Cortador de tomates en rodajas	33	Display vacío para brioches pequeñas	189
Cedazo 3 mallas	289	Cortador de tomates en rodajas - Compact pro	33	Display vacío para empujadores de masa	298
Cedazo 3 piezas	289	Cortador de verduras «Le Rouet Gourmet»	39		
Cedazo para harina	291	Cortador de verduras «Le Rouet»	39	E	
Cepillo de cocina	275	Cortador de verduras Japonés	37,39	El Cortador de salchichón «LUTIL»	132
Cepillo de horno	161	Cortador eléctrico de pasta para Chef in casa	70	Embudo automatico dosificador	294
Cepillo metálico	98	Cortador en bastoncillos palanca	37	Embudo con filtro	131
Cesta de pan / fruta	140	Cortador en tiras	37	Embutidora manual	66
Cesta para citricos	141	Cortador express bidireccional	24	Embutidora manual horizontal	67
Cesta para freir	121	Cortador manual de pasta para Chef in casa	70	Embutidora manual vertical - Acero inoxidable	67
Chocolatera	133	Cortador ondulado	63	Embutidora para Salchichas - Manual vertical	67
Clarificador profesional de huevos	81	Cortador-Estrellas	61	Embutidora para salchichas manual horizontal	67
Clip de merchandising negro	299	Cortadora de patés	78	Empujador Cuadrado	253
Cocedor de arroz eléctrico	119,120	Cortadora japonesa de verdura en espiral	39	Empujador de tartaletas	182
Cocedor de huevos eléctrico GN1/3	119	Cortadores de pastel	287	Empujador para corta lechuga	34
Cocedor de vapor eléctrico	119	Cortapasta con mango	285,286,287	Empujador para Corta-Patatas	29
Cocktail Master	130	Cortapasta redondo con borde enrollado	286	Empujador para cortador a gajos	53
Colador «chino» - estañado	291,292	Cortapizza	75	Empujador para cortador en bastoncillos	37
Colador cónico	94	Cuadrado	252	Empujador para Pelador de piñas	57,58
Combinados brasero/raclette de reblochon- «Edelweiss»	171	Cubeta pequeña	153	Empujador Redondo	252
		Cuchara de cocina	276	Envasadora al vacío semi-profesional	149
				Escurreidor para fritos	94

Espátula	91,92
Espátula biselada	276
Espátula blanca	284
Espátula con punta bies	91
Espátula cortapasta	284
Espátula de goma	92
Espátula grande	275
Espátula oblicua	91
Espátula para plancha	121
Espátula pequeña	275
Espátula profesional perforada	92
Espátula redonda	276
Espátula roja	284
Espátula T para crepes	122
Espátula T redonda para crepes	121,122
Espátula torneada con orificio	276
Espátula torneada con ranura	276
Espátula torneada maciza	276
Espolvoreadores	289
Espuma autoadhesiva	112
Espumadera araña	93
Espumadera araña tejida	93
Espumadera profesional	93
Espumadera reforzada	94
Espumaderas chinas en forma de cucharón	169
Estuche de 22 herramientas de decoración + piedra afiladora	61
Estufa de leña para fondue - decoración «abeto»	169
Expositor de mostrador de 10 afiladores	90
Expositor para moldes acanalados con recetas	298
Expositor para Pastéis de nata	298
Expositor para pastel individual	298
Exprimidor 1/2 rodaja de limón	127
Exprimidor de barra con palanca	127
Exprimidor de granadas y cítricos con palanca	127
Exprimidor de limón manual	127
Extractor de jugos	21
F	
Flanero acanalado «Bordelais»	206
Flanero redondo alto «dariolo»	206,240
Formas de inox	255,256,257,258,259,260
Fundidor de queso	167
G	
Guante cota de mallas	90
Guante resistente al calor ambidextro	122
Guante resistente al corte	90
Guía de corte	58
H	
Hilos para Mini guitarra GX	78
Hilos para Mini guitarra GXM	78
Hoja de recambio para máquina talladora de hortalizas	39
Hoja de recambio para rascador NPPR / NPPR1	88
Hoja reversible para abrelatas	98
Hornillo para fondue - decoración «abeto»	169
Huevera espiral	139
J	
Jarra graduada	272,291
Jarra isotérmica blanca	134
Jarra isotérmica negra	134

Jarras isotérmicas con dosificador	134
Jarras isotérmicas de servicio	133
Jarras isotérmicas de servicio Tapón enroscable	133
Juego de embudos para picadora N5600	64
K	
Kit «pâte à choux»	280
Kit 1001 tartas	207
Kit 3 cuchillas + empujadores Alligator	42
kit 3 rejillas para N3031	21
Kit alizador para OE750 - 12cm	97
Kit cuchilla - empujador	29
Kit cuchilla + empujador	28
Kit cuchillos + empujadores Alligator	42
Kit de repuesto para abrelatas eléctrico - OE750	97
Kit de repuesto para abrelatas eléctrico OEXTC	97
Kit de repuesto para abrelatas manual (Para O2 / OX)	103
Kit de repuesto para abrelatas manual (Para O3 / O5 / OX5)	103
Kugelhopf	203
L	
Letra	254
Licuada eléctrica	127
Lira (cortaqueso)	79
Lira (cortaqueso)	79
Lote de 10 hilos de repuesto para N3503	79
Lote de 10 hilos de repuesto para N3504	79
Lote de 10 hilos para cortar queso	79
Lote de 2 llaveros batidor de cocina	130
Lote de 3 Cortadores ALLIGATOR Original	41
Lote de 3 embudos para N4047C / N4047CX	67
Lote de 5 hilos de recambio N3506	78
Lote de 6 tablas de cortar	87
Lote de embudos para picadora manual N4022C	66
Lote de embudos para Salchichas - N5700	67
Lote de embudos para Salchichas - N5750	68
M	
Malla de recambio para cedazos	289
Mandolina japonesa - gama estándar	24
Mandolina japonesa - gama premium	24
Mandolina Para Trufas	25
Mandolina profesional	23
Mandolina super profesional	23
Mandolina Vivaldi	23
Mandoline Del Chef	23
Manga pastelera	279
Manga pastelera de cuti	279
Manga pastelera profesional reutilizable	280
Manopla de protección profesional	122
Máquina de pasta eléctrica - IMPERIA 150	72
Máquina de pasta eléctrica ATLAS 150	69
MAQUINA DE PASTA ELECTRICA IMPERIA RESTAURANTE	72
MAQUINA DE PASTA ELECTRONICA	72

Máquina de pasta manual - Pasta 150	72
Máquina de pasta manual ATLAS 150	69
Máquina de raclette ALPAGE®	165
Máquina de raclette ALPAGE® - Firmas - Basalte	166
Máquina de raclette ALPAGE® - Firmas - Inox	166
Máquina eléctrica para pasta - Chef in casa	70
Máquina talladora de hortalizas	39
Máquinas de pasta IMPERIA - modelo restaurante	72
Máquinas de raclette Brézière®	165
Máquinas de raclette Brézière® - Firmas - Basalte	165
Máquinas de raclette Brézière® - Firmas - Inox	165
Marco a Opera	261
Marco a Opera Ajustable Extensible	261
Marco a Opera con separador extradable	261
Marmita de sopa baño maría	120
Maxi guitarra	77
Maxi guitarra para productos planos	77
Maxi guitarra para productos redondos	77
Medidor licor doble 2/4 cl	129
Mini cesta de freír rectangular	121
Mini guitarra	77
Mini guitarra para productos planos	77
Mini guitarra para productos redondos	77
Mini Hamburguesa caballete	299
Mini molinillo de pimienta	139
Mini molinillo de sal	139
Mini pinza para emplatar	95
Mini termómetro digital electrónico	111
Mini-plancha de mesa 2 pers.	173
Mini-Plancha de Mesa 4 pers - base de madera	173
Mini-Plancha de Mesa 4 pers - base de metal	173
Molde - Corazón San Valentín	202
Molde «Charlotte»	202,238
Molde «Manqué» redondo liso	198,235
Molde «Manqué» redondo liso OBSIDIAN	218
Molde «Millasson» redondo liso	198
Molde «Soufflé»	202
Molde «Soufflé» - Individual	202
Molde aspic ovalado con fondo estrella	205,239
Molde aspic ovalado con fondo liso	205,239
Molde bizcocho de queso	203,238
Molde Brazo Gitano	183,225
Molde cake curvado bordeado con alambre	188,227
Molde cake estampado	188,227
Molde cake estampado OBSIDIAN	217
Molde Charlotte OBSIDIAN	219
Molde de brioche Obsidian	218
Molde de horno pequeño	186
Molde de Navidad - inox	263
Molde de pan perforado	185,225
Molde de pan rectangular	225
Molde de pan redondo	185,225
Molde desmontable	199
Molde desmontable para 12 muffins	181
Molde empanada	203
Molde flanero perforado	199

Molde individual para cake estampado	188	Pala para pizza cuadrada	75	Porta-brochetas 4 plazas	174
Molde largo para paté	187,226	Pala para pizza redonda	75	Porta-brochetas de inox con base de madera	175
Molde largo para paté (mini)	187,226	Palanca de nylon blanco -rilsan (Para O2 / OX)	103	Porta-brochetas de inox con base y soportes de salsa	175
Molde nido	121	Papas fritas en espiral	30	Porta-brochetas de plato con brochetas	175
Molde para «Génoise»	200,237,261	Par de cubiertos de ensalada	277	Porta-brochetas medieval de inox - Fijación alta	175
Molde para Club sandwich - Pan sorpresa	185	Pasapuré	17	Porta-brochetas medieval de inox - Fijación céntrica	175
Molde para muffin	205,240	Pasapuré eléctrico	19	Porta-brochetas medieval hierro forjado	175
Molde para pan de molde con tapa	185	Pasapuré estañado n°5	18	Porta-tostadas	141
Molde para panes hamburguesas	185	Pasapuré n°10	19	Portabrocheta de hierro forjado con base de madera	174
Molde para raviolis	74	Pasapuré n°2	17	Pórtico de brochetas	176
Molde tarta media bordes acanalados	195	Pasapuré N°3	17	Poster «La cocina»	299
Molde tarta media bordes lisos	195	Pasapuré N°3 inox	17	Prensa limónes manual	128
Molde tarta perforado redondo rizado - fondo movil Obsidian	218	Pasapuré n°5	18	Prensa para galletas IMPERIA	294
Molde Tronco de navidad redondeado	263	Pastéis de Nata	240	Prensa para latas	104
Moleta para abrelatas eléctrico OE750	98	Patatera de madera con tapa	167	Prensa para patés HACCP	68
Moleta para abrelatas manuales	103	Patatera de madera sin tapa	167	Prensa para pato	68
Moleta pequeña abrelatas eléctrico OEXTC / OE750	98	Pelador - Pollux	50	Prensador de ajo - productividad	42
Molinillo de pimienta Perfex®	139	Pelador con soporte brida	47,48	Prensapuré	20
Molinillo de sal Perfex®	139	Pelador de espárragos	49	Probador de salinidad y termómetro	112
Molino de tomate eléctrico	20	Pelador de manzanas doméstico	54	Protector de viento para Mini-Plancha de Mesas - lote de 2	173
Molino de tomate manual	20	Pelador de manzanas profesional KALI	54	Pudín Diplomático	203,238
Motor «Pastadrive» para N8001 / N8005 / N7994 / N8000 / N7994	69	Pelador de piñas	57	Puesto de trabajo con ruedas para OE750	98
Motor «Pasta fácil» para N7905 / N7905R / N7903 / N7908	72	Pelador de sandía y calabaza	49	Pulsador de seguridad universal	24
N					
Número	254	Pelador de verduras - Castor	50		
O					
Olla eléctrica de fondue china	169	Pelador eléctrico	49		
P					
Pack 15 moldes agrios profesional - Origine	243	Pelador eléctrico profesional	49		
Pack de 12 tartalelas redondas acanaladas	194	Pelador juliana - Castor	50		
Pack de 15 moldes cake profesional - Origine	243	Pelador manual de cítricos	49		
Pack de 25 moldes profesional cake mediano - Origine	243	Pelador mural	45,46		
Pack de 30 «Petits-fours»	204	Pelador para verduras grandes	49		
Pack de 50 moldes profesional muffins - Origine	243	Pelador piel fina - Pollux	50		
Pack de 6 «Millassons»	198	Pelador sobre pie	47		
Pack de 6 moldes de brioches pequeñas	189	Pelador sobre pie epoxy	47		
Pack de 6 moldes de brioches pequeñas OBSIDIAN	218	Pelador sobre pie inox	46		
Pack de 6 moldes individuales para cakes	188	Peladores de manzanas domésticos	54		
Pack de 6 tartalelas cuadradas acanaladas	197	Picadora eléctrica	64		
Pack de 6 Tartalelas de frutas frescas - Acanalada	193	Picadora eléctrica semi-pro n°12	65		
Pack de 6 tartalelas rectangulares acanaladas	196	Picadora eléctrica semi-pro n°22	65		
Pack de 6 tartalelas redondas acanaladas	194	Picadora eléctrica semi-pro n°5	64		
Pack de 6 tartalelas redondas acanaladas OBSIDIAN	217	Picadora manual n°22	65		
Pack de 60 «Petits-fours»	204	Picadora manual n°32	65		
Pack recetas	207	Piedra de parrilla con soporte	173		
Pala para girar los crepes	122	Piedras de parrilla	174		
Pala para patatas fritas	121	Pincel plano	277		
Pala para pizza	88	Pincel plano mango de Madera	277		
		Pincho para patata	167		
		Pinza de inox.	142		
		Pinza de inox. y PVC	142		
		Pinza de tostada	277		
		Pinza multiuso	142		
		Pinza para deshuesadora de cerezas	54		
		Pinza para emplatar	94		
		Pinza para ensalada	142		
		Pinza para masa	285		
		Pinza para Mini-Plancha de Mesa	173		
		Pinza para pimientos de parrilla	174		
		Pinza para sushi y sashimi	95		
		Pinza para té	131		
		Pinza porta fichas con bolitas	144		
		Pinza porta fichas con muelles	144		
		Pisón para cóctel	131		
		Pisón para Colador «chino»	292		
		Pisón Prensapuré	20		
		Placa plisada «Dientes de lobo»	182,223		
		Plato de asar	186		
		Pluma-cuchara	61		
		Porta-brochetas 2 plazas	174		
				R	
				Rack de copas	132
				Rack recoge-tablas	89
				Raclette horno + grill 6 personas	168
				Raclette tradicional «AMBIANCE»	167
				Raclette tradicional «PARTY»	167
				Raclette tradicional 2 x 1/2 queso	168
				Raclette tradicional 3 x 1/2 queso	168
				Rallador fino	79
				Rallador para queso - Manos libres	79
				Ralladora girolle giratoria	78
				Ralladora para moscada	79
				Ralladora para repollo	24
				Rascador de madera para trufas y verduras	25
				Rascador para molde tronco de navidad	263
				Rascador para Tabla de cortar	88
				Rascador para trufas y verduras	25
				Recarga de recetas (50)	299
				Recargas Agua de Seltz	130
				Recargas Kayser para sif n montador de nata	283
				Receptáculo para Alligator	42
				Recipiente para caja japonesa	154
				Recogemigas	143
				Rectangular	253
				Regarga recetas 50pz	299
				Regleta cortadora de plástico	150
				Rejilla 8 radios para picadora	64
				Rejilla de corte para Corta lechuga	34
				Rejilla estañada para Pasapuré n°5	18
				Rejilla para caja japonesa	154
				Rejilla para Pasapuré eléctrico	19
				Rejilla para Pasapuré n°10	19
				Rejilla para Pasapuré n°3	17
				Rejilla para Pasapuré n°5	18
				Rejilla para picadora	64
				Rejilla para picadora manual	66

Rejilla para picadora manual N4022C	66
Rejilla para picadora manual N4032C	66
Rejilla para spätzle - modelo doméstico	69
Rejilla para spätzle - modelo profesional	69
Rejilla tejida para tartas	293,294
Rejilla tejida cuadrada	293
Rejilla tejida rectangular para tartas	293,294
Rejilla tejida redonda para tartas	293
Resistencia concededor de aserrín	176
Retirador de enganche para tomates	33
Rodillo de repostería	273
Rodillo de repostería - Haya	273
Rodillo de repostería - Haya - Certificación PEFC	273
Rodillo de repostería - INOX	273
Rodillo de repostería - PP	273
Rodillo de repostería madera haya	273
Rodillo para cruasanes	285
Rodillo pincho	285
Rollos de bolsas al vacío gofradas	149

S

Sacabocados - Turn'up	62
Sacacorcho bodeguero 2 apoyos de apertura	129,130
Sacacorchos y abridor sumiller	129
Sacapuntas para verduras	63
Sartén rectangular	168
Savarín - Abierto	201,237
Savarín - Abierto - OBSIDIAN	218
Savarín acanalado «trois frères»	201,237
Savarín individual - Abierto	201,237
Savarín individual - Cerrado	201,237
Savarín profundo - Abierto	201,237
Secador para pasta	73
Seccionador de melón	59
Seccionador de sandías	59
Servilletero rectangular	140
Set de cortadores cuadrados FOOD DESIGNER®	62
Set de cortadores redondos FOOD DESIGNER®	62
Sifón Agua de Seltz	130
Sifón Pro KAYSER	283
Sifón semi-pro KAYSER	283
Sombrero tártaro - modelo con quemador	169
Sombrero tártaro - modelo eléctrico	169
Soplete de cocina	293
Soporte de mesa para cubo champán	140
Soporte de pared para caja para gorras de papel	160
Soporte de pared para caja para gorros redondos	160
Soporte de pared para caja para guantes	160
Soporte de pared para caja para mascarar	160
Soporte expositor para moldes	299
Soporte Maxi Guitarra	77
Soporte Mini Guitarra GX	77
Soporte para bandeja de mariscos	140
Soporte para coladores chinos	292
Soporte para morcillas	68
Soporte para piedra de parrilla	174
Soporte para vaso (pinza)	131
Soporte plano para Maxi Guitarra GXM	77

Soporte plano para Mini Guitarra GX	77
Soporte redondo para Mini Guitarra GX	77
Soporte redondo para Maxi Guitarra GXM	77
Soporte redondo para Mini Guitarra GX	77
Spray de fácil desmoldeo	294

T

Tabla de cortar blanca de PE inyectado	85
Tabla de cortar de madera	87
Tabla de cortar de madera para perejil - cake - chorizo	88
Tabla de cortar PE ECO	86,87
Tabla de cortar PE HD 500	85,86
Tabla de haya con canal sin tratar	88
Tapa para caja japonesa	154
Tapa para caja japonesa N4392T	154
Tapón con gatillo	134
Tapón de champán	130
Tapón dosificador	129
Tapón enroscable	133
Tarta acanalada casera	195,233,234
Tarta acanalada casera OBSIDIAN	217
Tarta cuadrada rizada	196,197,234
Tarta cuadrada rizada OBSIDIAN	217
Tarta de frutas frescas - Acanalada	193
Tarta rectangular acanalada	195,196,233
Tartaleta cuadrada acanalada	197,234
Tartaleta de frutas frescas - Acanalada	193
Tartaleta rectangular acanalada	196,234
Tartaleta redonda acanalada	193,194,232
Tartaleta redonda lisa	194,233
Tela de recambio	289
Tela de recambio para cedazos	289
Telas para hornear	273
Temporizador digital	114
Temporizador mecánico	114
Tenedor para chocolate	294
Tenedor para chocolate - espiral	294
Tenedor para chocolate - redonda	294
Tenedor para el chocolate	294
Termómetro con sonda	113
Termómetro congelador	113
Termómetro de cocina con carcasa	111
Termómetro digital con sonda rotativa	111
Termómetro electrónico	111
Termómetro electrónico - Sonda digital	112
Termómetro electrónico sonda «estilográfica» - Impermeable	112
Termómetro HACCP infrarrojo	111
Termómetro infrarrojo	111
Termómetro para carnicero	112
Termómetro para confitero	113
Termómetro para congelador	113
Termómetro para panadero	113
Tijeras hojas multiples	90
Tijeras universales	90
Tomates Mozzarella Rodajas	33
Tortiera acanalada perforada	192,231,232
Tortiera redonda acanalada	191,231
Tortiera redonda acanalada - Alta	192
Tortiera redonda acanalada - Alta	191,231,232
Tortiera redonda acanalada OBSIDIAN	217
Tortiera redonda acanalada perforada - Alta	192
Tortiera redonda acanalada perforada OBSIDIAN	218

Tortiera redonda lisa	193
Tortiera redonda lisa - Alta	193
Trefila de bronce Chef in Casa	71
Trefila de bronce Chef in Casa - Reginette	71

V

Vaciadores de bola FOOD DESIGNER®	62
Vaso dosificador	291
Vertedor con salida estrecha	129

1,2,3...

10000	23	123740	235	126441	232
101OCT	25	123750	235	126442	231
10201	24	123760	235	126445	232
10202	23	123770	235	126450	231
1020RT	25	123780	235	126451	232
10210	23	123790	235	126520	231
10211	23	123930	237	126522	231
1030RT	25	124030	237	126530	231
112620	238	124034	237	126532	231
114010	291	124040	237	126540	231
114110	291	124050	237	126542	231
114410	291	124110	236	126550	231
119410	226	124120	236	126620	232
119440	226	124210	236	126622	232
119710	226	124220	236	126630	232
119720	226	124340	237	126632	232
119730	226	124610	238	126640	232
119740	226	124810	235	126642	232
120010	226	124820	235	126650	232
120020	226	124940	233	126710	234
120030	226	124950	233	126810	234
120510	223	124990	233	127010	225
120710	223	125100	237	127020	225
120JB	24	125105	237	127030	225
121010	225	125110	237	127120	225
121020	225	125310	233	127130	225
121650	235	125410	233	129810	240
121660	235	125412	234	130210	239
122130	235	125710	233	130310	239
123010	228	125810	233	134000	225
123020	228	126320	231	134010	225
123030	228	126321	231	135010	225
123040	228	126322	231	15000	23
123050	228	126325	231	151210	238
123320	227	126325	231	154050	237
123330	227	126330	231	154060	237
123610	227	126331	231	164510	223
123620	227	126332	231	164710	223
123630	227	126335	231	164810	223
123640	227	126340	231	167030	223
123650	227	126341	231	185400	239
123660	227	126342	231	191010	239
123670	227	126345	231	191510	239
123680	227	126350	231	192010	239
123690	225	126351	231	192510	239
123701	235	126420	231	193470	232
123702	235	126421	232	193472	232
123705	235	126422	231	193480	232
123710	235	126425	232	193490	232
123720	235	126430	231	193510	239
123730	235	126431	232	193520	232
		126432	231	193530	232
		126435	232	193540	232
		126440	231		

193550	232	219310	185	223822	193
193560	232	219410	187	223930	201
193570	232	219440	187	224030	201
193572	232	219710	187	224034	201
193580	232	219720	187	224040	201
193590	232	219730	187	224050	201
193610	239	219740	187	224050-PK	207
193620	239	220010	187	224101	199
193630	233	220020	187	224110	199
193640	233	220030	187	224120	199
193650	233	220510	182	224210	199
193660	233	220710	181	224220	199
193670	233	221110	183	224340	201
193680	233	221640	199	224610	203
193710	228	221650	199	224810	199
193720	228	221660	199	224820	199
193730	228	221670	199	225100	200
193740	228	221680	199	225101	200
193750	228	221750	199	225105	200
193760	228	221770	199	225110	200
193770	228	222130	198	225120	200
194020	239	222630	188	225310	195
194030	239	223010	189	225410	195
194040	239	223020	189	225412	195
194050	239	223030	189	225710	195
194060	239	223040	189	225810	196
194070	239	223050	189	226120	191
194110	239	223060	189	226120-PK	207
194120	239	223320	188	226320	191
194130	239	223330	188	226321	192
194140	239	223610	188	226322	191
194150	239	223620	188	226325	192
194370	234	223630	188	226330	191
194470	234	223640	188	226331	192
195010	239	223650	188	226332	191
195330	234	223660	188	226335	192
195510	239	223670	188	226340	191
196010	239	223680	188	226340-PK	207
196510	239	223690	185	226341	192
196511	240	223701	198	226342	191
196515	240	223702	198	226345	192
196516	240	223705	198	226350	191
196517	240	223710	198	226351	192
20638B	23	223720	198	226420	191
20638CHB	23	223730	198	226421	192
20638CHBB	23	223740	198	226422	191
20644B	23	223750	198	226425	192
20660B	23	223760	198	226430	191
210910	185	223760-PK	207	226431	192
210920	202	223770	198	226432	191
212620	202	223780	198	226435	192
219010	185	223790	198	226440	191
219050	185	223801	193	226441	192

226442	191	255230	202	293660	194
226445	192	255610	200	293670	194
226450	191	258130	182	293680	194
226451	192	258230	184	293710	189
226520	191	258320	184	293720	189
226521	192	258321	184	293730	189
226522	191	258330	184	293740	189
226530	191	258430	184	293750	189
226531	192	264510	181	293760	189
226532	191	264710	181	293770	189
226540	191	264810	181	294010	204
226541	192	267030	182	294020	204
226542	191	270171	194	294030	204
226550	191	271011	205	294040	204
226620	192	271641	189	294050	204
226622	192	272710	201	294060	204
226630	192	282520	202	294070	204
226632	192	282540	194	294110	205
226640	192	282550	194	294120	205
226642	192	282560	194	294130	205
226650	192	282570	198	294140	205
226710	196	282580	185	294150	205
226810	197	285201	204	294370	197
226950	193	285400	204	294376	197
227005	186	291010	204	294470	197
227010	186	291510	204	294476	197
227020	186	291870	196	295010	204
227030	186	292010	204	295130	196
227120	186	292510	204	295330	196
227130	186	293030	203	295376	196
227310	193	293250	198	295510	204
227330	193	293270	198	295770	193
227340	193	293280	198	295790	193
227350	193	293290	198	296010	204
227840	195	293470	193	296510	204
227845	195	293472	193	296511	205
228020	203	293480	193	296512	205
228310	182	293490	193	296513	181
229810	206	293510	204	298410	182
230210	205	293520	194	298510	181
230310	205	293530	194	298610	184
231010	186	293540	194	299101	209
231020	186	293550	194	299102	209
234010	185	293560	194	299103	209
235010	185	293570	194	299104	210
235020	185	293572	194	299105	209
235110	202	293580	194	299106	210
25000	23	293590	194	299107	210
251210	203	293610	204	299108	209
252660	199	293620	204	299109	209
254050	201	293630	194	299110	210
254060	201	293640	194	299130	209
255130	202	293650	194	299201	210

299202	210	426431	218	815210	278
299203	210	426440	217	815220	279
299204	211	426441	218	815230	279
299205	211	426451	218	815310	278
299206	211	426810	217	815410	278
299220	211	4500CLR	39	815420	278
299230	211	454050	218	815510	278
300RP	79	458320	215	815610	278
30300	24	458321	215	815810	278
30400	24	464510	215	815850	279
305253	299	464710	215	817930	263
305254	299	464810	215	817931	263
305255	299	470171	217	817932	263
305256	299	493740	218	817933	263
305257	299	496512	218	824910	246
305258	299	5013	168	824920	246
307130	298	5029	168	824930	246
307131	298	614530	267	824940	246
307132	298	614580	267	824941	246
307136	298	614590	267	824942	246
307138	298	615530	268	824943	246
307139	189	615535	268	824944	246
307140	298	615580	268	824945	246
307146	299	615590	268	824950	246
308730	279	64JB	24	824960	246
313110	279	703SF1	83	824970	246
313120	279	703SF1P	83	824980	246
313130	279	703SX	83	824990	246
313140	279	714510	267	824992	246
313160	279	714530	267	824994	246
317020	277	714560	267	825150	261
317030	277	714590	267	825160	261
317040	277	714595	267	834910	246
317050	277	722630	188	834920	246
317310	292	726630	188	834930	246
317910	284	729510	206	834940	246
317920	284	729520	206	834941	246
319110	182	729530	206	834942	246
35CPX	83	729540	206	834943	246
4030CLR	39	800710	263	834944	246
4100CLR	39	803CHP1	141	834950	246
412620	219	803CHP2	141	834960	246
420710	215	803CHP3	141	834970	246
423040	218	813710	299	834980	246
423320	217	813850	249	834990	246
423730	218	814410	292	834992	246
423750	218	814550	267	834994	246
423760	218	814560	267	834995	246
425410	217	814565	267	835530	247
426320	217	814570	263	835540	247
426330	217	814580	263	835550	247
426340	217	814590	267	835560	247
426350	217	814595	267	844910	286

844920	286	863790	255	865690	251
844930	286	864180	255	866004	252
844940	286	864330	253	866005	252
844950	286	864350	253	866010	252
844960	286	864370	253	866020	252
844970	286	864390	253	866030	252
844980	286	864840	252	866040	252
845010	286	864904	251	866050	252
845020	286	864905	251	866060	252
845030	286	864910	251	866260	249
845040	286	864920	251	866280	249
845050	286	864930	251	866320	250
845060	286	864940	251	866330	250
845070	286	864950	251	866340	250
845080	286	864960	251	866350	250
845090	286	864970	251	866360	250
845130	286	864980	251	866370	250
845140	286	864990	251	866420	249
845150	286	865000	249	866440	249
845160	286	865001	249	866460	249
845170	287	865003	249	866480	249
845180	287	865004	249	866510	255
845200	287	865010	250	866600	252
8485FI	25	865011	250	866610	252
8485JAPGN	24	865012	250	866630	252
8485LA	25	865020	250	866632	252
8485MO	25	865030	250	866640	252
8486FI	25	865040	250	866650	252
8486JAPP	24	865050	250	866660	252
8486LA	25	865060	250	866740	253
8486MO	25	865070	250	866750	253
8490JAPP	24	865080	250	866755	253
860430	255	865090	250	867010	255
862740	255	865092	250	867360	253
862750	255	865102	249	867420	252
862760	255	865104	249	867430	252
863010	256	865105	249	867505	253
863020	256	865110	249	867510	253
863050	256	865120	249	867530	253
863070	256	865130	249	867540	253
863110	256	865140	249	867560	253
863260	256	865150	249	867740	253
863310	252	865160	249	867760	253
863320	252	865170	249	868010	255
863322	252	865180	249	868110	255
863330	252	865190	249	868510	256
863340	252	865310	247	868610	255
863350	252	865320	247	868630	256
863360	252	865530	247	868640	256
863370	252	865540	247	868660	256
863410	255	865550	247	868680	256
863510	255	865560	247	868710	255
863540	255	865680	251	868730	255

868810	257	884005	259	884420	254
869005	252	884007	258	884421	254
869010	252	884008	258	884422	254
869030	252	884009	259	884423	254
869110	255	884012	257	884424	254
869130	255	884013	257	884425	254
869230	255	884015	257	884426	254
869330	255	884017	256	884427	254
869530	256	884018	256	884428	254
869610	256	884019	257	884429	254
869630	256	884021	257	884430	254
869730	256	884023	256	884431	254
871220	252	884027	260	884432	254
873220	259	884028	260	884433	254
875910	253	884029	260	884434	254
877310	257	884030	260	884435	254
877630	253	884031	257	884436	254
877821	250	884032	256	884437	254
880001	286	884034	257	884438	254
880101	286	884035	257	884439	254
881780	253	884042	287	884501	259
883901	256	884043	287	884502	260
883902	256	884048	255	884641	254
883903	256	884049	255	884642	254
883907	257	884101	257	884643	254
883908	259	884104	257	884644	254
883909	259	884105	257	884645	254
883910	259	884106	257	884646	254
883918	259	884107	260	884647	254
883920	260	884108	258	884648	254
883921	260	884110	258	884649	254
883922	260	884111	258	884650	254
883923	260	884115	258	884651	254
883924	260	884120	258	884652	254
883925	260	884121	258	884653	254
883926	260	884122	259	884654	254
883927	260	884123	259	884655	254
883928	260	884124	259	884656	254
883929	260	884125	258	884657	254
883930	260	884127	259	884658	254
883933	260	884128	258	884659	254
883934	260	884129	257	884660	254
883942	260	884130	258	884661	254
883943	259	884131	259	884662	254
883944	259	884132	259	884663	254
883945	260	884139	256	884664	254
883946	259	884141	258	884665	254
883948	255	884142	258	884666	254
883953	260	884144	259	884709	260
883972	256	884145	258	884711	260
884001	259	884154	258	884712	259
884002	258	884201	287	884713	260
884004	258	884202	287	887902	286

CP10	27
CP13	27
CS00	27
CS06	27
CS08	27
CS10	27
CS13	27
CSA	34
CSA01	34
CSA02	34
CSAL	34
CSAL01	34
CSAL02	34
CSAM	34
CSAM01	34
CSAM02	34
CSP10	28
CT-MZ	33
CT3X	20
CT3X-EL	20
CTE00	61
CTE01	61
CTER01	78
CTER02	78
CTX	33
CTX40	33
CTXM55	33
CX00	27
CX00-P	28
CX06	27
CX06-P	28
CX08	27
CX08-P	28
CX10	27
CX10-P	28
CX13	27
CX13-P	28
D	
DF030	150
DF045	150
DFV300	150
DFV450	150
DO1250	291
DO251	130
DO956	129
DP000	150
DP212-J	129
DP213-V	129
DP214-B	129
DP215	129
E	
E0010.	48

E0011.	48
E0012.	48
E0019.	48
EA-EL	57
EA.	57
EA001	57
EA002	57
EA003	57
EA004	57
EA005	57
EA006	57
EA007	57
EA008	57
EA009	57
EA010	58
EA013	57
EA014	58
EA095	57
EA102	57
EM001.	45
EM002.	45
EM003.	46
EM004	46
EMX001	45
EMX002	45
EMX003	45
EMX004	45
EP001.	47
EP002.	47
EP003.	47
EP004.	47
EPX001.	46
EPX002.	46
EPX003.	46
EPX004	46
ESJX001	47
ESJX002	47
ESJX003	48
ESJX004	48
EX5010	19
EX5015	19
EX5020	19
EX5030	19
EX5040	19
EX5M100	19
EX5M130	19
EX5T100	19
EX5T130	19
F	
FAF	176
FAF01	176
FAFR	176

FVX1	83
G	
GAN13	122
GB20P009	273
GL19P001	243
GL19P004	243
GL19P005	243
GL19P006	243
GL19P010	299
GL19P011	293
GL19P013	275
GL19P014	275
GL19P015	275
GL19P016	275
GL19P017	294
GL20P003	272
GL20P004	272
GL20P005	272
GL20P011	207
GL303	272
GL304	273
GL305	273
GL306	273
GL307	276
GL308	276
GL309	276
GL310	277
GL311	277
GL312	272
GL313	272
GL314	272
GL315	272
GL316	272
GL317	272
GL318	272
GL319	272
GL320	272
GL321	280
GL322	280
GL323	280
GL324	280
GL325	280
GL326	276
GL327	276
GL328	276
GL329	272
GX01	77
GX012	77
GX014	77
GX015-2	78
GX02	77
GX022	77

GX024	77	LT2106	93	N3011T	41
GX03	77	LT2107	93	N3011X-03	42
GX04	77	LT2108	93	N3011X-06	42
GX052	77	LT2109	93	N3011X-09K	42
GX053	77	LT2110	93	N3011X-12	42
GXM012	77	LT2111	93	N3011X-K	42
GXM015-2	78	LT2112	94	N3020	292
GXM022	77	LT2113	94	N3023-09	28
GXM03	77	LT2114	94	N3023-12	28
GXM04	77	LT2115	94	N3023VLT	28
GXM05	77	LT2116	94	N3024	20
GXM052	77	LT2117	142	N3025	20
GXM053	77	LT2118	142	N3027	78
GXM06	77	LT2119	142	N3028	20
H		LT2120	93	N3031	21
HV12-EL	65	LT2121	93	N3032	21
HV1222-OPTCT	65	LT2122	93	N3040	151
HV22-EL	65	LT2123	93	N3040-F	151
HV5-EL	64	LT2124	93	N3040-P	151
HV5-OPTCT	65	LT2125	93	N3042	151
I		LT2126	93	N3042-F	151
ID1000	61	LT2127	142	N3042-P	151
ID1100	63	LT2128	142	N3066	142
ID1101	63	LT2129	142	N3067	142
ID1205	62	LT2130	142	N3068	142
ID1207	62	LT2131	88	N3069	142
ID2500	61	LT21P001	90	N3072	142
ID2580	61	LT21P002	90	N3073	142
ID4006	49	LT21P003	90	N3074	142
ID4007	49	LT21P004	90	N3078	33
ID4036	63	M		N3079	49
ID4100	62	M500	18	N3082	130
ID5000	294	M5010	18	N3087R	122
ID5001	294	M5015	18	N3087RL	122
ID5002	294	M5020	18	N3091	90
ID5003	294	M5030	18	N3092	90
ID5004	294	M5040	18	N3100	112
K		M510	18	N3109	112
KRFA01	79	M515	18	N3110	112
L		M520	18	N3111	112
LT19P001	143	M530	18	N3113	113
LT19P002	143	M540	18	N3114	113
LT20A009	28	MLT.	39	N3115	113
LT20P002	140	MLT01.	39	N3116	113
LT20P003	140	N		N3117	113
LT20P004	140	N3004X	17	N3118	112
LT2101	88	N3011	41	N3119	111
LT2102	93	N3011-B	42	N3120	113
LT2103	93	N3011-BX	42	N3121	113
LT2104	93	N3011-C	41	N3122	111
LT2105	93	N3011R	41	N3123	111
		N3011S	41	N3124	111
				N3124C	111

N3127	111	N40204C	66	N4188X	81
N3236	42	N40206C	66	N4190	79
N3422	90	N40208C	66	N4197	62
N3500	79	N40212C	66	N4200	58
N3503	79	N40215C	66	N4206	54
N35031	79	N40221C	66	N4207	54
N3504	79	N4022C	65	N4210	58
N35041	79	N4022C-S	66	N4212	58
N3506	78	N40304C	66	N4214	59
N35061	78	N40306C	66	N4215	59
N3515	79	N40308C	66	N4220	49
N3665	107	N40312C	66	N4221	49
N3670-A	108	N40315C	66	N4225	49
N3671	107	N40321C	66	N4230	54
N3672	107	N4032C	65	N4231	54
N3673	107	N4032C-S	66	N4232T	54
N3681	107	N4039X	94	N4233	54
N3682	107	N4041	103	N4298	42
N3684	107	N4043-ID	121	N4312	129
N3685	107	N4043-IDG	121	N4313	129
N3686	107	N4047C	67	N4319	130
N3690	108	N4047CXE	67	N4390C	154
N3691	108	N4054	130	N4390T	154
N3692	108	N4055X	130	N4391C	154
N3693	107	N4056	104	N4391G	154
N3693-A	108	N4057	104	N4391T	154
N3694	107	N4074	130	N4392C	154
N3695	108	N4075X	130	N4392G	154
N3696	108	N4083X	283	N4392T	154
N3697	107	N4084X	283	N4401	153
N3697-A	108	N4086X	283	N4403	153
N3702	75	N4087X	283	N4404	153
N3703	284	N4097	127	N4408	153
N37031	284	N4098	127	N4409	153
N37032	284	N4105	127	N4410	153
N3705	289	N4107	128	N4411	153
N3707	289	N4110	141	N4412	153
N3711	291	N4120	127	N4413	153
N3715	294	N4120-24P	127	N4504	167
N3716	287	N4134	131	N4905	133
N3720	273	N4135	129	N5069	133
N3725	284	N4136	131	N5069-B	133
N3726	285	N4140	131	N5070	133
N3728	285	N4142-20	131	N5071	133
N3728-2	285	N4150	139	N5072	133
N3730	284	N4151	139	N5072-B	134
N3731	284	N4153	139	N5076	134
N3738	284	N4154	139	N5077	134
N3740	131	N4155	139	N5078	134
N3924	293	N4183	81	N5084	134
N3992	94	N4184	81	N5085	134
N3993	94	N4184X	81	N5088	134
N3995	94	N4185	54	N5089	134

N5308	133	N7917-07	71	NC010	93
N5312	133	N7917-08	71	NC012	289
N5316	133	N7917-09	71	NC013	289
N5400	121	N7917-10	71	NC014	289
N5600	64	N7917-11	71	NC015	289
N5600-03	64	N7917-12	71	NC016	89
N5600-06	64	N7917-13	71	NC018D	132
N5600-07	64	N7917-14	71	NC019	121
N5600-08	64	N7917-15	71	NC020	140
N5600-C	64	N7917-16	71	NC020-C	140
N5600-S	64	N7919	294	NC024	140
N5700	67	N7932	72	NC027	293
N5700-S	67	N7933	72	NC028	293
N5750	67	N8001	69	NC036	139
N5750-S	68	N8001-E	69	NC052	174
N5900	66	N8003	70	NC057	93
N7004	83	N8004	69	NC061	141
N7010	24	N8005	69	NC070	275
N7013	83	N8006	69	NC071	275
N7105V	63	N8008	62	NC072	275
N7900	72	N8012	50	NC073	275
N7900-01	72	N8013	50	NC074	275
N7900-02	72	N8014	50	NC075	275
N7900-03	72	N8015	50	NC076	275
N7900-04	72	N8019	104	NC077	275
N7900-05	72	N8028	144	NC1011460	93
N7900-06	72	N8029	144	NC1011660	93
N7900-07	72	N8030	144	NC1012860	93
N7905	72	N8031	144	NC1017260	94
N7905-01	73	N8033	144	NC1018160	121
N7905-02	73	N8040	132	NC1043960	121
N7905-03	73	N8060	120	NC1053860	293
N7905-04	73	N8090	119	NC1053960	293
N7905-05	73	N8091	133	NC1054060	294
N7905-06	73	N8093	119	NC3016050	141
N7905-07	73	N8093-P	119	NC4250060	174
N7905-08	73	N8094	119	NC4250460	174
N7905-11	73	N8110	119	NC5020760	294
N7905-E	72	N8201	112	NC5060760	289
N7905R	72	N8900	120	NC5061760	289
N7906	72	N9200	131	NC5062860	289
N7907	73	N9201	132	NC5064660	289
N7910	74	N9202	132	NC5064760	289
N7911	74	NBR01	161	NC5065660	289
N7912	74	NBR02	161	NC5065760	289
N7913	74	NC001	93	NC7020160	141
N7917	70	NC003	93	NC8090660	169
N7917-01	70	NC004	93	NCS011	273
N7917-02	70	NC005	93	NCS301	273
N7917-03	71	NC006	68	NCS601	273
N7917-04	71	NC007	293	NDS301	120
N7917-05	71	NC008	293	NDS500	141
N7917-06	71	NC009	293	NK001	283

NK002	283	NPP8-V	87	NV012	149
NK003	283	NPP9	86	NV013	149
NM20-1	91	NPP9-B	87	NV014	149
NM25-1	91	NPP9-J	87	NV015	149
NM30-1	91	NPP9-R	87	NV400	149
NM35-1	91	NPP9-V	87	NVS010	119
NM40-1	91	NPPC	87	NVS020	119
NMB25-1	92	NPPL28	88	NVS030	119
NMPA30	92	NPPL40	88	NY100	68
NMPA40	92	NPPL45	88	NY300	68
NMPA45	92	NPPR	88		
NP20-1	277	NPPR01	88	O	
NP25-1	277	NPPR1	88	O2820-2	103
NP30-1	277	NPS22	277	O2830-5	98
NP35-1	277	NPX30	75	O2870-5	103
NP40-1	277	NPX31	75	O2873-5	98
NPB07	87	NRC01-1	121	O2895	103
NPB28	75	NRC01X	122	O2P55	102
NPB33	75	NRC02-1	122	O2V55	102
NPB40	75	NRC03-1	122	O3870-5	103
NPP11-J	86	NRP43	273	O3895	103
NPP11-N	85	NRP47	273	O3P40	102
NPP11-R	86	NRP50	273	O3V40	102
NPP11-V	86	NRPP45	273	O5P55	102
NPP14	86	NRPP50	273	O5V55	102
NPP2	85	NS007	272	OBSXP55	101
NPP4	85	NS008	291	OBSXV55	101
NPP4-B	86	NSPO25-1	91	OE7502	97
NPP4-J	86	NSPO30-1	91	OE750M	97
NPP4-M	85	NSPO35-1	91	OE750M-110	97
NPP4-R	86	NSPO40-1	91	OE750T	97
NPP4-V	86	NSPO50	91	OE750X	97
NPP41	85	NSPO60	91	OE7553	98
NPP5	85	NSPO80	91	OE7554-2	98
NPP5-B	86	NSP100	91	OE7620-B	97
NPP5-J	86	NSP120	91	OE7620.	97
NPP5-R	86	NSPA25	92	OE896	97
NPP5-V	86	NSPA30	92	OEX821	98
NPP51	85	NSPA35	92	OEXTC	97
NPP51-M	86	NSPA40	92	OX5P55	101
NPP6	85	NSPA45	92	OX5V55	101
NPP6-B	86	NSPA50	92	OXV55	101
NPP6-J	86	NSPB25-1	91		
NPP6-M	85	NSPB30-1	91	P	
NPP6-P	85	NSPB35-1	91	P1000	19
NPP6-R	86	NSPB40-1	91	P10010	19
NPP6-V	86	NSPS28	92	P10015	19
NPP61	85	NSPS29	92	P10020	19
NPP61-M	86	NSPS31	92	P10030	19
NPP7	86	NSPT100	92	P10040	19
NPP8	86	NSPT120	92	P1010	19
NPP8-B	87	NV010	149	P1015	19
NPP8-R	87	NV011	149	P1020	19

P1030	19
P1040	19
PAP3	285
PAP4	94
PAP5	95
PAP6	95
PB1	299
PB2	299
PBC06C	175
PFO1	78
PF06	78
PF08	78
PIER-P	174
PIERO1	173
PIERO3	173
PIER17	174
PIER25	174
PLAN-P	173
PLAN-PV	173
PLAN01	173
PLAN02	173
PLAN05	173
PLU03M	61
POBE01	175
POBE02	175
POBN01t	174
POBN01V	174
POBX01	175
POBX01-S	175
POBX01V	175
POBX4C	175
POBX4D	175
PORT01	176
PORT02	176
PRESTE01	68
PSX05	67
PSX08	67
PTX21	98

R

RACL01	165
RACL01BA	166
RACL01NX	166
RACL02	165
RACL02C	165
RACL03	165
RACP01NX	168
RAM	143
REB01	166
REB02	166
REB03	166
RECH02	169
RECH02-KIT	169

S

S2	17
S3	17
S3015	17
S3025	17
S3040	17
SEP-OC	167
SEP-R	167
SEP-RC	167
SHMX	159
SHPX	159
SM006	59
SM008	59
SM01	59
SM06	59
SM08	59
SMP04	59
SMP06	59
SMP08	59
SPO1	69
SPOE01	81
SUP01	174
SUP03	174

T

TAS	132
TAT	24
TBCOU01-N	129
TBCOU02-R	129
TORT06	83
TORT08	83
TR10	58
TTM02-PB	168
TTM03	167
TTM05	167
TTM05C-110	167
TTM10	167
TTM10C-110	167
TTM20	168
TTM30	168
TTM40CE	168
TTM80AL	169
TTM80E	169
TTMFC01	169
TU01	62
TU02	62
TU03	62

U

UMD01	114
UMM01	114
UTD01	111

X

X3-F	17
X3015	17
X3025	17
X3040	17
X500	18
X5010	18
X5015	18
X5020	18
X5030	18
X5040	18
X510	18
X515	18
X520	18
X530	18
X540	18



LOUIS TELLIER S.A.S.

Siège : 116 Quai de Bezons - 95100 ARGENTEUIL

Tél. +33 (0)1 34 11 38 38

www.louistellier.fr

info@louistellier.fr

Showroom : 5 rue Debrou - ZI de la Gare - 37300 JOUÉ-LÈS-TOURS - France